

# Differential pressure gauge with micro switches With integrated working pressure indication (DELTA-comb) Model DPGS40

WIKA data sheet PV 27.20



for further approvals  
see page 5

**DELTA-comb**

## Applications

Monitoring and control of filters, compressors and pumps in:

- Marine boilers, pressure vessels, bilge-water collection
- Drinking and cooling-water treatment plants
- Pressure-boosting stations
- Heating technology
- Fire-extinguishing systems

## Special features

- Robust aluminium case with shatterproof window
- Low measuring range from 0 ... 250 mbar
- Optionally with Ex approval
- High ingress protection, IP65, for outdoor use and processes with high condensation



**Differential pressure gauge with integrated working pressure indication and two switch contacts, model DPGS40, cable gland**

## Description

The differential pressure gauges of the DELTA-line product family are primarily used for the monitoring and control of low differential pressures where there are high requirements in terms of one-sided overpressure and static pressure. Typical markets for these products are the shipbuilding industry, process heating technology, the heating, ventilation and air-conditioning industries, the water/wastewater industry, and machine building and plant construction. For these, the main function of the measuring instruments is the monitoring of filters, compressors and pumps.

Wherever a differential pressure has to be indicated locally and, at the same time, circuits need to be switched safely dependent on a defined differential pressure, the DELTA-comb finds its use. As the pressure passes above or below a defined set point, the switching operation is triggered. The switch point is accessible from the front and can be set in the range of 10 ... 100 % of the full scale value via an assistant scale.

Often in these applications, alongside the indication of the differential pressure, the current working pressure is also relevant.

For this reason, a working pressure indication is integrated within the DELTA-comb differential pressure switch as standard. The two local, easily readable, mechanical displays need no power supply and enable the simultaneous reading of the working and the differential pressure. Furthermore, this saves on an additional measuring and sealing point, reducing additional expense for piping and mounting.

The robust aluminium case and shatterproof window enable a long service life of the product, even under harsh ambient conditions. As a result of the low measuring range of 0 ... 250 mbar, the instrument can also be used for applications with low differential pressures.

The new and functional design completes the appearance of the measuring instrument.

## Design and operating principle

Pressures  $p_1$  and  $p_2$  act on the media chambers  $\oplus$  and  $\ominus$ , which are separated by an elastic diaphragm (1).

The differential pressure ( $\Delta p = p_1 - p_2$ ) leads to an axial deflection of the diaphragm against the measuring range springs (2).

The deflection, which is proportional to the differential pressure, is transmitted to the movement (4) in the indicating case and to the leaf springs of the micro switches (5) via a pressure-tight and low friction rocker arm (3).

Overpressure safety is provided by metal bolsters (6) resting against the elastic diaphragm.

The setting of the switch point is made by the adjustment screws accessible from the front (7). The assistant scales (8) simplify the setting of the switch point.

## Illustration of the principle

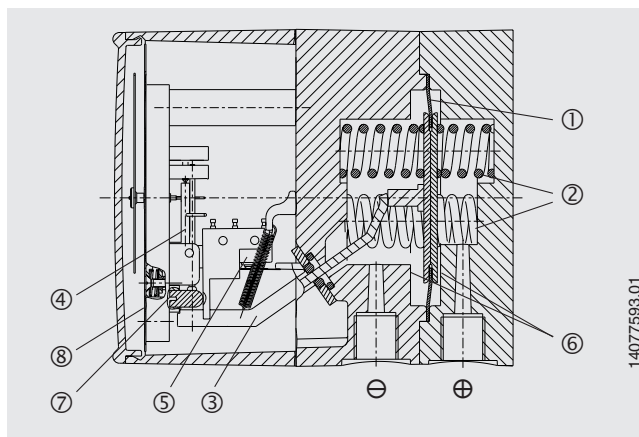

Mounting according to affixed symbols:  
 $\oplus$  high pressure,  $\ominus$  low pressure

Mounting:

- Rigid measuring line
- Wall mounting with available mounting links

## Standard version

Specifications	
Nominal size	Differential pressure indication: $\varnothing$ 100 mm Working pressure indication: $\varnothing$ 22 mm
Accuracy	Differential pressure indication: $\leq 2.5$ % of span (option $\leq 1.6$ %) Working pressure indication: $\leq 4$ % of span
Scale ranges (EN 837)	Differential pressure: 0 ... 0.25 to 0 ... 10 bar Working pressure: 0 ... 25 bar
Max. working pressure (stat.)	25 bar
Overpressure safety	Either side max. 25 bar
Permissible temperature	Ambient: -10 ... +70 °C Medium: -10 ... +90 °C Storage: -40 ... +70 °C
Ingress protection	IP65 per IEC/EN 60529
Media chamber (wetted)	Aluminium, EN AC-Al Si9Cu3(Fe), black lacquered (option: Stainless steel 1.4571)
Process connections (wetted)	2 x G 1/4 female, lower mount, in-line, centre distance 26 mm
Pressure elements (wetted)	Differential pressure: Compression springs from stainless steel 1.4310 and separating diaphragm from FPM/FKM (option: NBR) Working pressure: Bourdon tube from Cu-alloy
Transmission parts (wetted)	Stainless steel 1.4301, 1.4305, 1.4310, FPM/FKM (option: NBR)
Sealings (wetted)	FPM/FKM (option: NBR)
Movement	Copper alloy
Dial	Differential and working pressure indication: White dial, black lettering
Pointer	Differential and working pressure indication: Blue pointer
Zero adjustment for differential pressure indication	Via screw in the dial
Case	Aluminium, EN AC-Al Si9Cu3(Fe), black lacquered
Window	Plastic, with plug screw for zero and switch point adjustment
Weight	approx. 1.4 kg

## Options

- Intrinsically safe versions (Ex i)
- Without working pressure indication
- Scale range for working pressure 0 ... 10 or 0 ... 16 bar (max. working pressure and overpressure safety up to 10 or 16 bar)
- Accuracy class 1.6 for differential pressure indication with fixed factory-set switch points for scale ranges from 0 ... 1 bar to 0 ... 10 bar (specify switching direction)
- 4-way valve manifold from Cu-alloy or stainless steel, (1 x pressure compensating valve, 2 x shut-off valve, 1 x valve for purging and ventilating)
- Sealings (model 910.17, see data sheet AC 09.08)
- Other process connections for female and male threads
- Compression fittings with ferrule or clamp ring for pipe diameters 6, 8 and 10 mm
- Mounting flange (available in 2 versions: Stainless steel or stainless steel, black lacquered)
- Electrical connection via cable terminal box or angular connector

Electrical contact	
<b>Type of contact</b>	Micro switch
<b>Contact function</b> Single change-over contact Double change-over contact	Contact type 850.3 Contact type 850.3.3
<b>Load data</b> U max., I max., P max.	AC 250 V, 5 A, 250 VA      DC 30 V, 0.4 A, 10 W
<b>Switch point setting</b>	from the outside at assistant scale by means of adjustment screw(s)
<b>Setting range</b>	from 10 % to 100 % of the full scale value
<b>Switch point reproducibility</b>	≤ 1.6 %
<b>Switch hysteresis</b>	max. 5 % of the full scale value (option: max. 2.5 %)
<b>Electrical connection</b>	Cable gland M20 x 1.5 with 1 m free cable

### Maximum values for the power supply circuit (only for Ex version)







Parameters	Instrument group II	
	Potentially explosive gas atmosphere	Potentially explosive dust atmosphere
<b>Terminal marking</b>	"1" / "4" / "2" for switch A "3" / "6" / "5" for switch B (option)	
<b>Voltage U<sub>i</sub></b>	DC 30 V	
<b>Current I<sub>i</sub></b>	100 mA	
<b>Power P<sub>i</sub></b>	1 W	≤ 750 mW for Ta ≤ +40 °C ≤ 650 mW for Ta ≤ +60 °C
<b>Effective internal capacitance C<sub>i</sub></b>	Negligible	
<b>Effective internal inductance L<sub>i</sub></b>	Negligible	

### Instruments with two micro switches

If more than one circuit is connected, all conditions for the separation of two intrinsically safe circuits must be observed.



## Approvals

Logo	Description	Country
	<b>EU declaration of conformity</b> <ul style="list-style-type: none"> <li>■ Pressure equipment directive</li> <li>■ Low voltage directive</li> <li>■ RoHS directive</li> <li>■ ATEX directive (option)</li> </ul>	European Union
	<b>IECEX</b> (option) Hazardous areas	International
	<b>EAC</b> (option) <ul style="list-style-type: none"> <li>■ EMC directive</li> <li>■ Pressure equipment directive</li> <li>■ Low voltage directive</li> <li>■ Hazardous areas</li> </ul>	Eurasian Economic Community
	<b>GOST</b> (option) Metrology/measurement technology	Russia
	<b>KazInMetr</b> Metrology, measurement technology	Kazakhstan
	<b>UkrSEPRO</b> Metrology, measurement technology	Ukraine
	<b>Uzstandard</b> Metrology, measurement technology	Uzbekistan
-	<b>CRN</b> Safety (e.g. electr. safety, overpressure, ...)	Canada

## Certificates (option)

- 2.2 test report per EN 10204 (e.g. state-of-the-art manufacturing, indication accuracy)
- 3.1 inspection certificate per EN 10204 (e.g. indication accuracy)

Approvals and certificates, see website

## Ordering information

Model / Scale range / Process connection / Material of separating diaphragm and sealings / Micro switch / Options

© 01/2014 WIKA Alexander Wiegand SE & Co. KG, all rights reserved.  
The specifications given in this document represent the state of engineering at the time of publishing.  
We reserve the right to make modifications to the specifications and materials.