

- OPTIMISED AERODYNAMIC DESIGN
- HIGHLY EFFICIENT AND ENERGY-SAVING
- GALVANISED FINISH
- HFW
IE3-COMPLIANT MOTORS > 7.5kw
- HFW/L/EW
HIGH PERFORMANCE
IE4-COMPLIANT E.C.
INDUSTRIAL MOTORS
- HFW/EW
IE3-COMPLIANT MOTORS WITH A
BUILT-IN ELECTRONIC
VARIABLE DRIVE

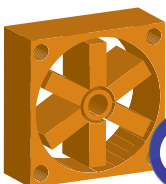

HFW

GALVANISED FINISH
TUBULAR FANS



According EU Regulation



HFW

Short cased axial fans with galvanised finish

Cased axial fans with pad mounted motors and mounting arms designed to reduce noise and vibration. The aluminium impellers are aerodynamically designed to improve efficiency.



Fan:

- Airflow direction from motor to impeller
- Cast aluminium impellers
- Sheet steel casing with double flange and cable gland
- Steel Galvanised case

Finish:

- Hot-galvanised

Motor:

- IE2 efficiency between 0.75kW and 5.5kW inclusive
- IE3 efficiency motors above 7.5 kW.
- Class F motors, with ball bearings and IP55 protection
- Three phase 230/400V, 50Hz. (up to and including 4kW) and 400/690V, 50Hz. (above 4kW)
- Working temperature: -25°C+ 50°C.

Available on request:

- Airflow direction from impeller to motor.
- PL version impellers - made from glass fibre reinforced polyamide
- 100% reversible impellers
- Motors suitable for non-standard electrical supplies
- ATEX certification, Category 2

Order Code

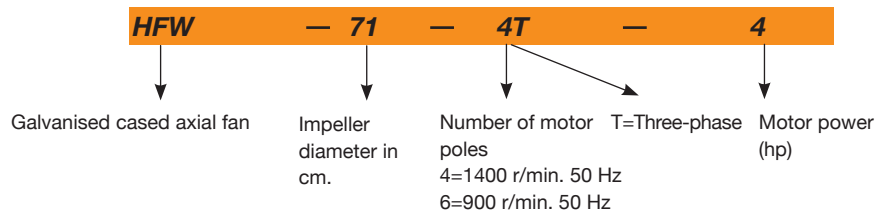

Technical Characteristics

Model	Speed (r/min)	Maximum admissible current (A)			Installed power (kW)	Impeller blade angle (°)	Maximum Airflow (m³/h)	Sound pressure level dB(A)	Approx. Weight (Kg)
		230V	400V	690V					
HFW-56-4T-1	1410	3.10	1.79		0.75	22	11250	73	28
HFW-56-4T-1.5	1400	4.03	2.32		1.10	30	13600	74	32
HFW-56-4T-2	1430	5.96	3.44		1.50	36	15050	75	30
HFW-56-6T-0.75	910	2.59	1.49		0.55	38	10150	62	23
HFW-63-4T-1	1410	3.10	1.79		0.75	14	15200	73	29
HFW-63-4T-1.5	1400	4.03	2.32		1.10	20	17800	74	32
HFW-63-4T-2	1430	5.96	3.44		1.50	24	19300	75	35
HFW-63-4T-3	1445	8.36	4.83		2.20	32	22150	76	43
HFW-63-4T-4	1445	10.96	6.33		3.00	38	24250	77	45
HFW-63-6T-0.75	910	2.59	1.49		0.55	28	13600	65	29
HFW-63-6T-1	945	3.90	2.20		0.75	38	15900	66	35
HFW-71-4T-1.5	1400	4.03	2.32		1.10	12	19500	78	35
HFW-71-4T-2	1430	5.96	3.44		1.50	14	20900	79	38
HFW-71-4T-3	1445	8.36	4.83		2.20	22	25100	81	47
HFW-71-4T-4	1445	10.96	6.33		3.00	28	27500	82	49
HFW-71-6T-0.75	910	2.59	1.49		0.55	20	16100	67	31
HFW-71-6T-1	945	3.90	2.20		0.75	26	17300	68	38
HFW-71-6T-1.5	945	4.88	2.82		1.10	34	19950	69	40
HFW-80-4T-3	1445	8.36	4.83		2.20	12	25450	82	55
HFW-80-4T-4	1445	10.96	6.33		3.00	16	30250	83	57
HFW-80-4T-5.5	1440	14.10	8.12		4.00	18	32750	84	62
HFW-80-6T-1.5	945	4.88	2.82		1.10	18	21450	72	48
HFW-80-6T-2	955	6.42	3.71		1.50	26	25950	73	54
HFW-80-6T-3	955	9.30	5.30		2.20	32	29950	74	59
HFW-90-4T-4	1445	10.96	6.33		3.00	8	33600	87	66
HFW-90-4T-5.5	1440	14.10	8.12		4.00	12	38900	89	71
HFW-90-4T-7.5	1440		10.60	6.14	5.50	18	46150	91	87
HFW-90-4T-10	1465		8.06	13.90	7.50	22	50150	92	98
HFW-90-6T-2	955	6.42	3.71		1.50	16	28800	77	63
HFW-90-6T-3	955	9.30	5.30		2.20	24	34000	78	68
HFW-90-6T-4	960	12.70	7.30		3.00	30	38900	79	92
HFW-100-4T-7.5	1440		10.60	6.14	5.50	10	46850	92	95
HFW-100-4T-10	1465		8.06	13.90	7.50	16	57400	93	106
HFW-100-4T-15	1470		20.90	12.10	11.00	22	66300	94	129
HFW-100-4T-20	1470		28.30	16.40	15.00	28	76150	95	148
HFW-100-6T-3	955	9.30	5.30		2.20	16	37600	82	76
HFW-100-6T-4	960	12.70	7.30		3.00	20	41150	83	100
HFW-100-6T-5.5	960	16.50	9.46		4.00	26	47800	84	108

Acoustic Features

The specified values are determined according to free field measurements of pressure and sound levels in dB(A) at an equivalent distance of twice the fan's external diameter plus the impeller's diameter, with a minimum of 1.5 m.

Sound power Lw(A) spectrum in dB(A) via frequency band in Hz.

	63	125	250	500	1000	2000	4000	8000		63	125	250	500	1000	2000	4000	8000
HFW-56-4T-1	48	68	76	81	83	80	73	62	HFW-80-4T-4	56	76	84	89	91	88	81	74
HFW-56-4T-1.5	49	69	77	82	84	81	74	63	HFW-80-4T-5.5	56	76	84	89	91	88	81	70
HFW-56-4T-2	50	70	78	83	85	82	75	64	HFW-80-6T-1.5	49	66	74	79	81	78	71	60
HFW-56-6T-0.75	37	57	65	70	72	69	62	51	HFW-80-6T-2	50	67	75	80	82	79	72	61
HFW-63-4T-1	50	70	78	83	85	82	75	64	HFW-80-6T-3	51	68	76	81	83	80	73	62
HFW-63-4T-1.5	48	68	76	81	83	80	73	65	HFW-90-4T-4	61	82	89	94	97	93	86	79
HFW-63-4T-2	52	68	76	81	83	80	73	66	HFW-90-4T-5.5	60	81	88	93	96	92	85	74
HFW-63-4T-3	53	70	78	83	85	82	77	67	HFW-90-4T-7.5	59	80	87	92	95	91	84	73
HFW-63-4T-4	54	71	79	84	86	83	78	68	HFW-90-4T-10	58	79	86	91	94	90	83	72
HFW-63-6T-0.75	42	60	68	73	75	72	65	56	HFW-90-6T-2	58	79	86	91	94	90	83	72
HFW-63-6T-1	43	62	70	75	77	74	67	57	HFW-90-6T-3	56	70	77	82	85	81	74	63
HFW-71-4T-1.5	54	74	82	87	89	86	79	69	HFW-90-6T-4	57	72	79	84	87	83	76	65
HFW-71-4T-2	53	73	81	86	88	85	78	70	HFW-100-4T-7.5	64	84	92	97	99	96	89	78
HFW-71-4T-3	58	72	80	85	87	84	77	71	HFW-100-4T-10	62	82	90	95	97	94	87	76
HFW-71-4T-4	59	73	81	86	88	85	78	72	HFW-100-4T-15	61	81	89	94	96	93	86	75
HFW-71-6T-0.75	44	63	72	74	76	73	66	55	HFW-100-4T-20	63	83	91	96	98	95	88	77
HFW-71-6T-1	45	65	73	75	77	74	67	56	HFW-100-6T-3	61	72	80	85	87	84	77	66
HFW-71-6T-1.5	46	66	71	76	78	75	68	57	HFW-100-6T-4	64	72	80	85	87	84	77	66
HFW-80-4T-3	57	77	85	90	92	89	82	73	HFW-100-6T-5.5	64	73	81	86	88	85	78	67



ErP. BEP (Best Efficiency Point) characteristics

PN	Motor's nominal power in kW	ηe[%]	Efficiency
MC	Measurement Category	N	Degree of Efficiency
EC	Efficiency Category	[kW]	Electrical Power
S	Static	[m3/h]	Airflow
T	Total	[mmH2O]	Static or total pressure (According to EC)
VSD	Variable-Speed Drive	[RPM]	Speed
SR	Specific Relationship		

Model	MC	EC	VSD	SR	ηe[%]	N	(kW)	(m³/h)	(mmH₂O)	(RPM)
HFW-56-4T-1	A	S	NO	1.00	37.2%	44.1	0.837	7959	14.38	1438
HFW-63-4T-1	C	S	NO	1.00	49.8%	56.5	0.868	9291	17.07	1436
HFW-63-4T-1.5	C	S	NO	1.00	47.9%	53.7	1.193	10625	19.76	1447
HFW-63-4T-2	C	S	NO	1.00	42.3%	47.4	1.551	12026	20.03	1449
HFW-63-4T-3	B	T	NO	1.00	61.9%	65.8	2.447	20324	27.38	1439
HFW-63-4T-4	B	T	NO	1.00	62.6%	65.9	3.020	24239	28.64	1440
HFW-63-6T-0.75	B	T	NO	1.00	57.7%	65.4	0.611	12174	10.64	949
HFW-63-6T-1	B	T	NO	1.00	57.1%	63.7	0.930	15880	12.29	942
HFW-71-4T-1.5	C	S	NO	1.00	47.9%	53.4	1.346	12330	19.20	1440
HFW-71-4T-2	C	S	NO	1.00	48.4%	53.6	1.495	13405	19.83	1450
HFW-71-4T-3	C	S	NO	1.00	42.8%	46.8	2.369	17056	21.84	1441
HFW-71-4T-4	C	S	NO	1.00	40.7%	44.0	2.976	19369	22.96	1441
HFW-71-6T-0.75	C	S	NO	1.00	40.3%	47.7	0.678	10743	9.35	944
HFW-71-6T-1	C	S	NO	1.00	38.4%	45.2	0.842	12404	9.58	947
HFW-71-6T-1.5	C	S	NO	1.00	34.0%	40.1	1.103	14226	9.69	955
HFW-80-4T-3	C	S	NO	1.00	47.0%	51.0	2.417	16923	24.69	1440
HFW-80-4T-4	C	S	NO	1.00	44.5%	47.4	3.404	20444	27.19	1432
HFW-80-4T-5.5	C	S	NO	1.00	43.6%	46.1	4.011	22304	28.78	1457
HFW-80-6T-1.5	C	S	NO	1.00	40.2%	45.9	1.224	14613	12.35	951
HFW-80-6T-2	C	S	NO	1.00	39.2%	44.0	1.764	17576	14.46	962
HFW-80-6T-3	C	S	NO	1.00	37.1%	41.1	2.317	20444	15.44	956
HFW-90-4T-4	C	S	NO	1.00	51.9%	55.2	3.028	19656	29.36	1440
HFW-90-4T-5.5	C	S	NO	1.00	50.5%	53.0	4.049	25081	29.94	1456
HFW-90-4T-7.5	C	S	NO	1.00	47.7%	49.0	6.251	31521	34.72	1465
HFW-90-4T-10	C	S	NO	1.01	46.1%	46.8	7.730	35009	37.36	1467
HFW-90-6T-2	C	S	NO	1.00	45.8%	50.8	1.625	19416	14.08	965
HFW-90-6T-3	C	S	NO	1.00	41.1%	44.8	2.615	23753	16.64	950
HFW-90-6T-4	C	S	NO	1.00	37.7%	40.6	3.515	27183	17.92	970
HFW-100-4T-7.5	C	S	NO	1.00	52.1%	53.9	5.240	30466	32.94	1471
HFW-100-4T-10	C	S	NO	1.00	48.9%	49.4	8.112	37591	38.73	1466
HFW-100-4T-15	C	S	NO	1.01	44.7%	44.3	11.841	44571	43.65	1470
HFW-100-4T-20	C	S	NO	1.01	41.3%	40.1	15.684	50259	47.37	1471
HFW-100-6T-3	C	S	NO	1.00	45.0%	48.9	2.474	24629	16.62	953
HFW-100-6T-4	C	S	NO	1.00	43.9%	47.1	3.131	27632	18.28	974
HFW-100-6T-5.5	C	S	NO	1.00	38.9%	41.2	4.429	32373	19.56	971

Dimensions in mm

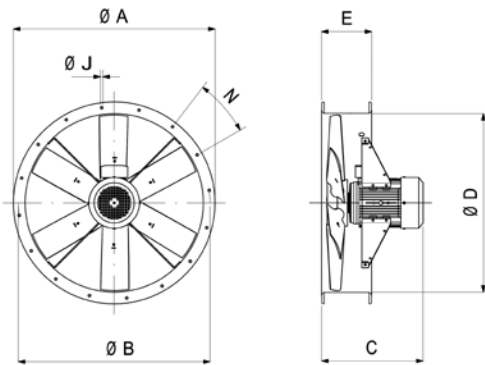

	ØA	ØB	C										ØD	E	ØJ	N			
			0.75	1	1.5	2	3	4	5.5	7.5	10	15					20		
HPW-56-4	665	620	-	330	380	380	-	-	-	-	-	-	-	-	-	560	225	12	12x30°
HPW-56-6	665	620	330	-	-	-	-	-	-	-	-	-	-	-	-	560	225	12	12x30°
HPW-63-4	735	690	-	379	429	429	470	470	-	-	-	-	-	-	-	640	225	12	12x30°
HPW-63-6	735	690	379	429	-	-	-	-	-	-	-	-	-	-	-	640	225	12	12x30°
HPW-71-4	815	770	-	-	389	389	430	430	-	-	-	-	-	-	-	710	225	12	16x22°30'
HPW-71-6	815	770	339	389	389	-	-	-	-	-	-	-	-	-	-	710	225	12	16x22°30'
HPW-80-4	905	860	-	-	-	-	436	436	460	-	-	-	-	-	-	800	225	12	16x22°30'
HPW-80-6	905	860	-	-	395	436	460	-	-	-	-	-	-	-	-	800	225	12	16x22°30'
HPW-90-4	1018	970	-	-	-	-	-	401	425	485	525	-	-	-	-	900	225	15	16x22°30'
HPW-90-6	1018	970	-	-	-	401	425	485	-	-	-	-	-	-	-	900	225	15	16x22°30'
HPW-100-4	1118	1070	-	-	-	-	-	-	-	488	528	643	703	-	-	1000	225	15	16x22°30'
HPW-100-6	1118	1070	-	-	-	-	428	488	528	-	-	-	-	-	-	1000	225	15	16x22°30'

Characteristic Curves

Q = Airflow in m³/h, m³/s and cfm.

Pe = Static pressure in mmH₂O, Pa and in w.g.

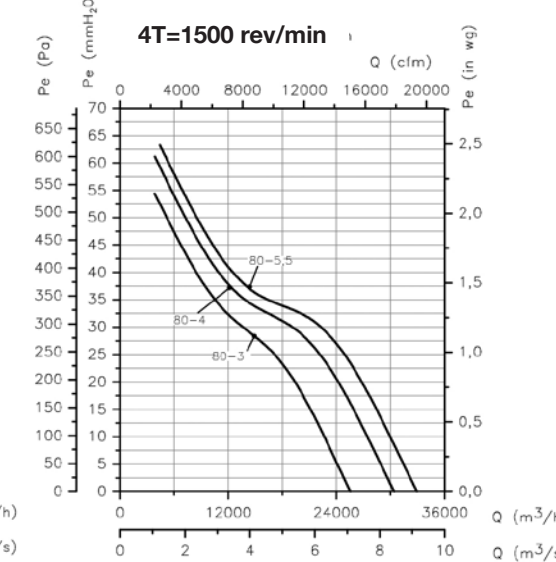
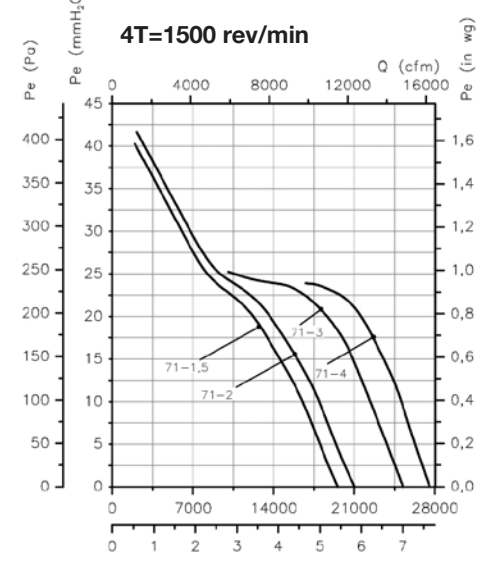
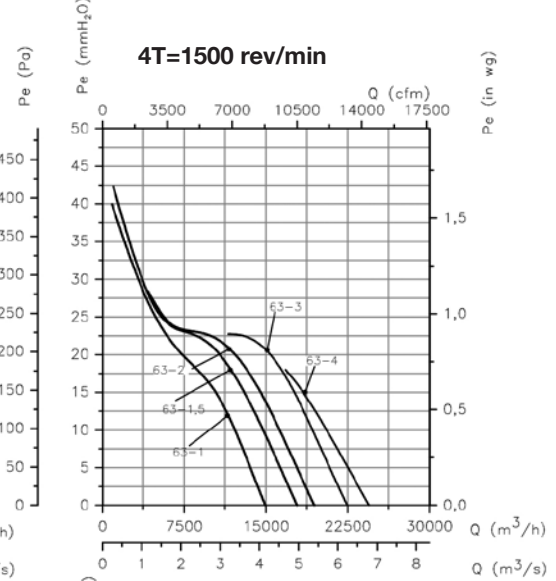
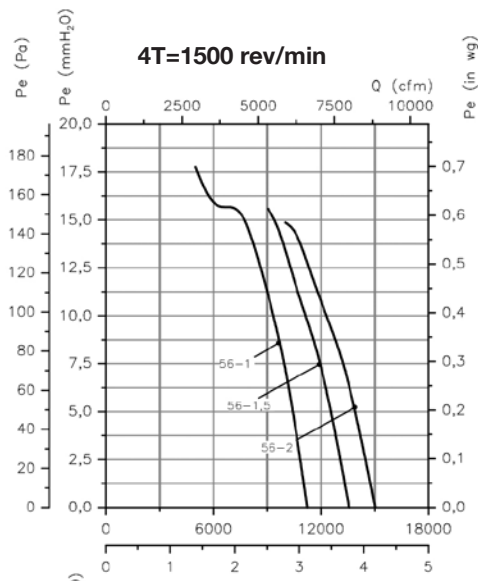

Characteristic Curves

Q = Airflow in m³/h, m³/s and cfm.

Pe = Static pressure in mmH₂O, Pa and in w.g.

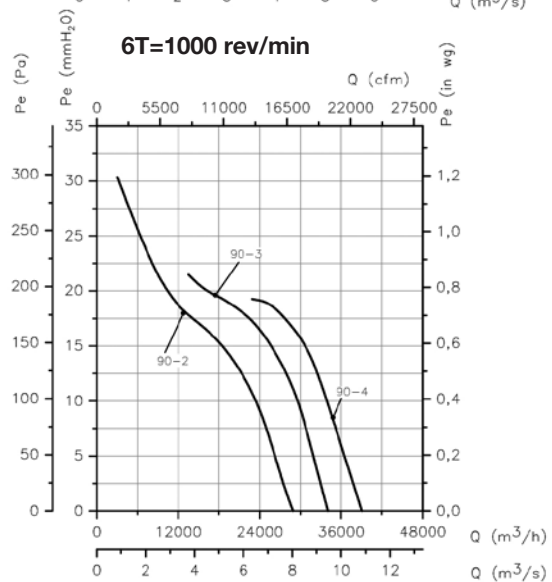
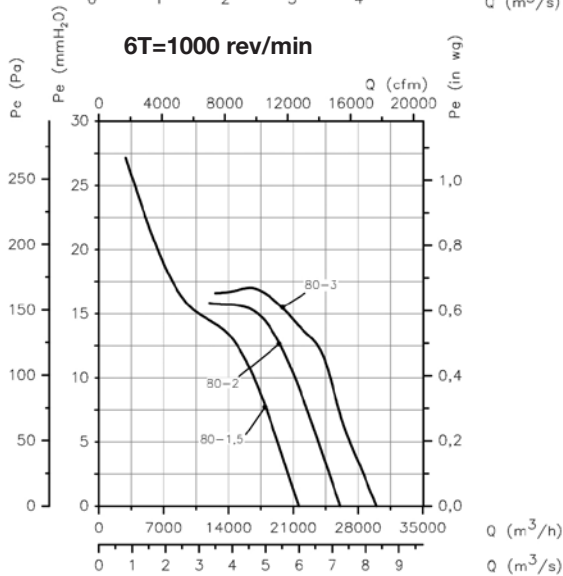
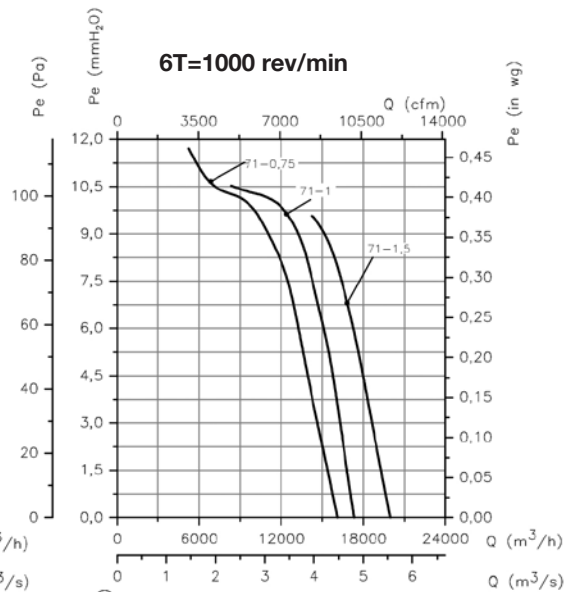
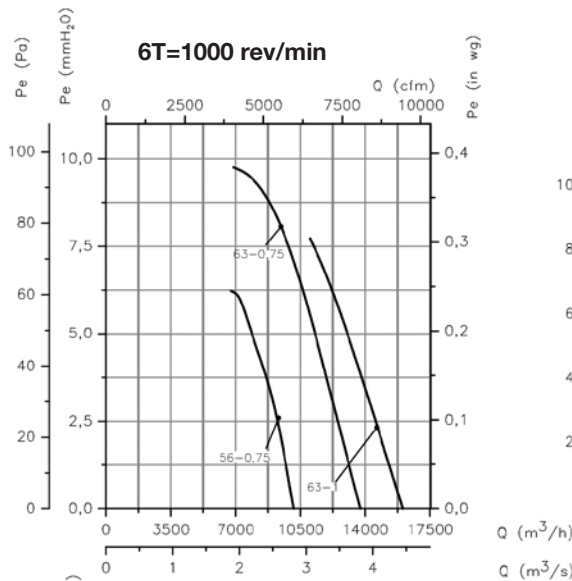
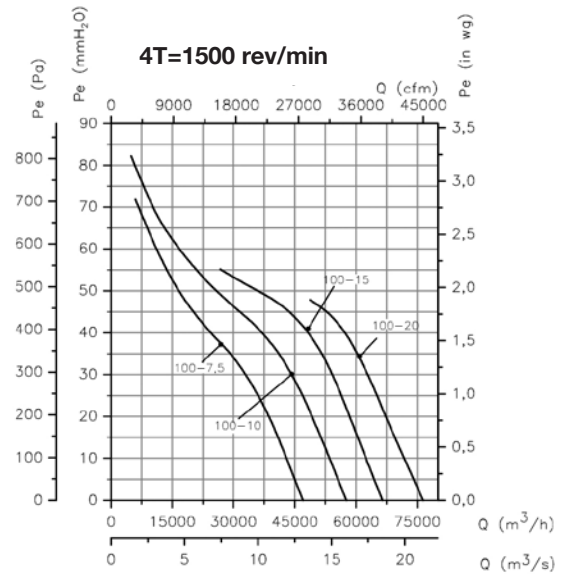
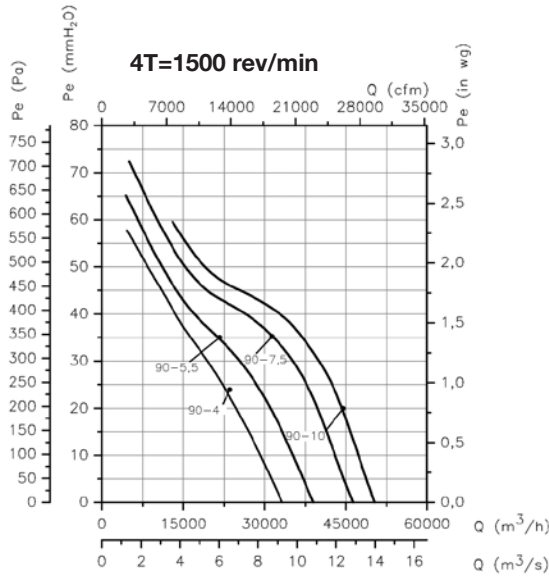

Characteristic Curves

Q = Airflow in m³/h, m³/s and cfm.

Pe = Static pressure in mmH₂O, Pa and in w.g.

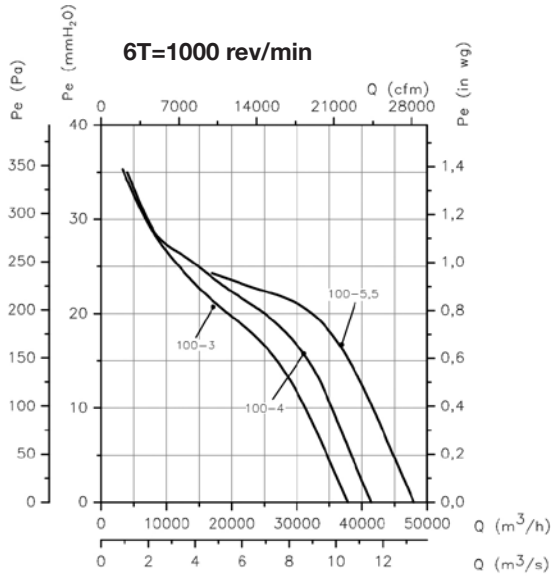

Accessories

See accessories section.



HFW-L/EW

Cased axial fans with EC motors



VARIABLE SPEED DRIVE
VSD: Variable Speed Drive.
. VSD1/B
. VSD3/B

Supplied with fan

CONTROL
Supplied as an optional accessory

SUPPLY
VSD1/B:
220-240 V 50/60 Hz
VSD3/B:
380-415 V 50/60 Hz

Cased axial fans with pad mounted motors and mounting arms designed to reduce noise and vibration. Complete with aerodynamically designed impellers and EC motors.

Fan:

- Airflow direction from motor to impeller
- Cast aluminium impellers
- Sheet steel casing with double flange and cable gland
- Steel Galvanised case
- Electronic variable speed drive (VSD), is supplied with fan (three phase or single-phase)

- By default, the electronic variable speed drive (VSD) is delivered programmed to run at a constant speed
- Fan working temperature: -25 °C +50°C.
- VSD working temperature: -25 °C +50 °C.

Finish:

- Hot-galvanised

Available on request:

- Airflow direction from impeller to motor
- PL version impellers - made from glass fibre reinforced polyamide
- 100% reversible impellers

Motor and electronic variable drive:

- High-efficiency, IE4-compliant E.C. motors fitted with electronic variable speed drive (VSD), which can be adjusted through an external 0-10 V control signal. IP65 Protection
- The external signal can be supplied through a manual or automatic control with 0-10 V output.
- Electronic variable speed drives (VSD) are available with single-phase 220-240V 50/60Hz input (VSD1/B type) or three-phase 380-415V 50/60Hz (VSD3/B type). Standard IP20 protection, IP66 protection available on order

Order Code

HFW-L/EW — 56 — 4 — 1 — B — T — D

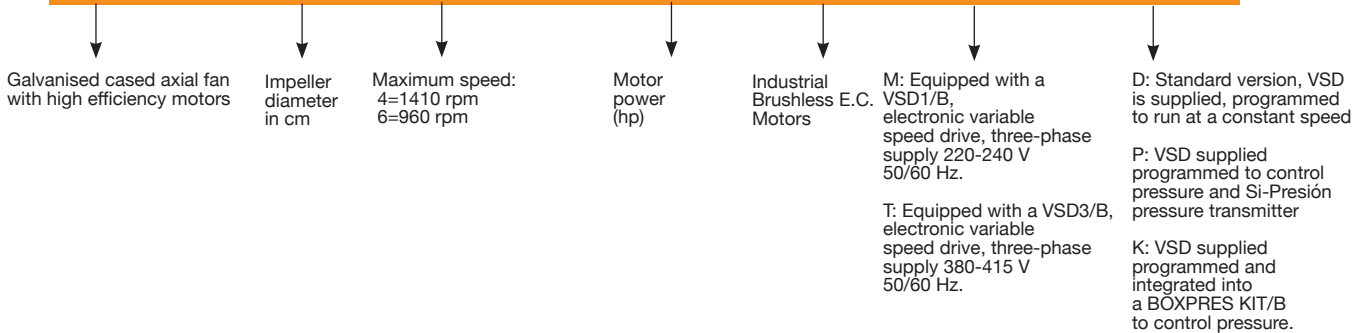

Technical Characteristics

Model	Speed min/max (r/min)	Single-phase VSD 230 V 50/60 Hz		Three-phase VSD 400 V 50/60 Hz		Maximum electrical power (W)	Maximum Airflow min/max (m³/h)	Sound pressure level min/max dB(A)	Approx. Weight (Kg)
		Maximum input current (A)	Model VSD	Maximum input current (A)	Model VSD				
HFW-L/EW-56-4-1	300 / 1410	7.94	VSD1/B-0.75	1.87	VSD3/B-0.75	905	2395 / 11250	39 / 73	28.0
HFW-L/EW-56-4-1.5	300 / 1410	11.25	VSD1/B-0.75	2.65	VSD3/B-1.5	1295	2895 / 13600	40 / 74	32.0
HFW-L/EW-56-4-2	300 / 1410	15.89	VSD1/B-1.5	3.74	VSD3/B-1.5	1825	3200 / 15050	41 / 75	30.0
HFW-L/EW-56-6-0.75	300 / 900	5.64	VSD1/B-0.75	1.32	VSD3/B-0.75	635	3385 / 10150	38 / 62	23.0
HFW-L/EW-63-4-1	300 / 1410	7.94	VSD1/B-0.75	1.87	VSD3/B-0.75	905	3235 / 15200	39 / 73	29.0
HFW-L/EW-63-4-1.5	300 / 1410	11.25	VSD1/B-0.75	2.65	VSD3/B-1.5	1295	3785 / 17800	40 / 74	32.0
HFW-L/EW-63-4-2	300 / 1410	15.89	VSD1/B-1.5	3.74	VSD3/B-1.5	1825	4105 / 19300	41 / 75	35.0
HFW-L/EW-63-6-0.75	300 / 900	5.64	VSD1/B-0.75	1.32	VSD3/B-0.75	635	4535 / 13600	41 / 65	29.0
HFW-L/EW-63-6-1	300 / 900	8.32	VSD1/B-1.5	1.96	VSD3/B-1.5	955	5300 / 15900	42 / 66	35.0
HFW-L/EW-71-4-1.5	300 / 1410	11.25	VSD1/B-0.75	2.65	VSD3/B-1.5	1295	4150 / 19500	44 / 78	35.0
HFW-L/EW-71-4-2	300 / 1410	15.89	VSD1/B-1.5	3.74	VSD3/B-1.5	1825	4445 / 20900	45 / 79	38.0
HFW-L/EW-71-6-0.75	300 / 900	5.64	VSD1/B-0.75	1.32	VSD3/B-0.75	635	5365 / 16100	43 / 67	31.0
HFW-L/EW-71-6-1	300 / 900	8.32	VSD1/B-1.5	1.96	VSD3/B-1.5	955	5765 / 17300	44 / 68	38.0
HFW-L/EW-71-6-1.5	300 / 900	11.51	VSD1/B-1.5	2.71	VSD3/B-1.5	1325	6650 / 19950	45 / 69	40.0

Acoustic Features

The specified values are determined according to free field measurements of pressure and sound levels in dB(A) at an equivalent distance of twice the fan's external diameter plus the impeller's diameter, with a minimum of 1.5 m.

Sound power Lw(A) spectrum in dB(A) via frequency band in Hz. Maximum speed

	63	125	250	500	1000	2000	4000	8000		63	125	250	500	1000	2000	4000	8000
HFW-L/EW-56-4-1	48	68	76	81	83	80	73	62	HFW-L/EW-63-6-0.75	42	60	68	73	75	72	65	56
HFW-L/EW-56-4-1.5	49	69	77	82	84	81	74	63	HFW-L/EW-63-6-1	43	62	70	75	77	74	67	57
HFW-L/EW-56-4-2	50	70	78	83	85	82	75	64	HFW-L/EW-71-4-1.5	54	74	82	87	89	86	79	69
HFW-L/EW-56-6-0.75	37	57	65	70	72	69	62	51	HFW-L/EW-71-4-2	53	73	81	86	88	85	78	70
HFW-L/EW-63-4-1	50	70	78	83	85	82	75	64	HFW-L/EW-71-6-0.75	44	63	72	74	76	73	66	55
HFW-L/EW-63-4-1.5	48	68	76	81	83	80	73	65	HFW-L/EW-71-6-1	45	65	73	75	77	74	67	56
HFW-L/EW-63-4-2	52	68	76	81	83	80	73	66	HFW-L/EW-71-6-1.5	46	66	71	76	78	75	68	57

Dimensions in mm

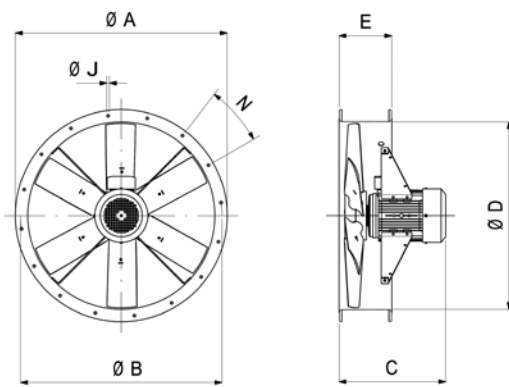

Model	ØA	ØB	C	ØD	E	ØJ	N
HFW-L/EW-56-4-1	665	620	330	560	225	12	12x30°
HFW-L/EW-56-4-1.5	665	620	380	560	225	12	12x30°
HFW-L/EW-56-4-2	665	620	380	560	225	12	12x30°
HFW-L/EW-56-6-0.75	665	620	330	560	225	12	12x30°
HFW-L/EW-63-4-1	735	690	379	640	225	12	12x30°
HFW-L/EW-63-4-1.5	735	690	429	640	225	12	12x30°
HFW-L/EW-63-4-2	735	690	429	640	225	12	12x30°
HFW-L/EW-63-6-0.75	735	690	379	640	225	12	12x30°
HFW-L/EW-63-6-1	735	690	429	640	225	12	12x30°
HFW-L/EW-71-4-1.5	815	770	389	710	225	12	16x22°30'
HFW-L/EW-71-4-2	815	770	389	710	225	12	16x22°30'
HFW-L/EW-71-6-0.75	815	770	339	710	225	12	16x22°30'
HFW-L/EW-71-6-1	815	770	389	710	225	12	16x22°30'
HFW-L/EW-71-6-1.5	815	770	389	710	225	12	16x22°30'

Accessories

See accessories section.

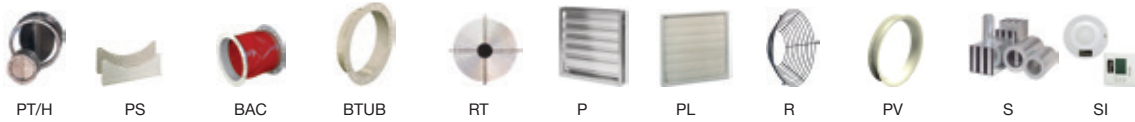



ErP. Characteristic Curves and ErP Data

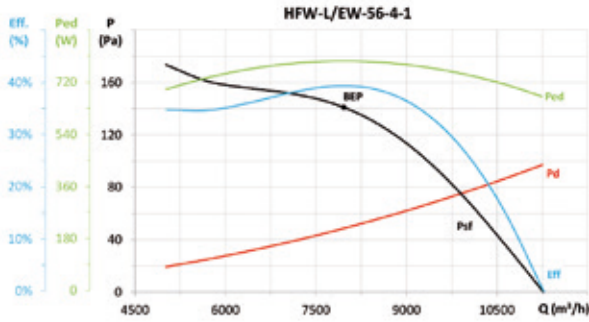

MC	EC	SR	Cc	η_e (%)*	N	[kW]	[m³/h]	[Pa]	[rpm]	VSD
A	S	1,00	1,09	43,0%	50,0	0,793	7959	141	1410	INCLUDED

* η_e (%) = Eff. (%) x Cc

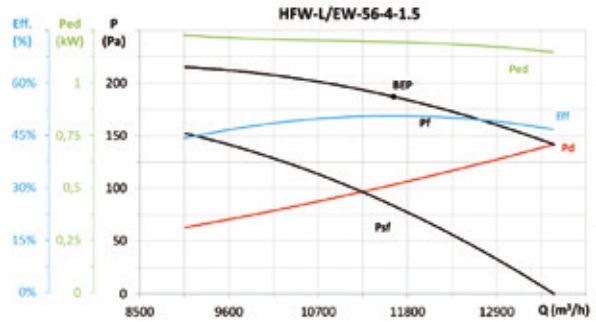

MC	EC	SR	Cc	η_e (%)*	N	[kW]	[m³/h]	[Pa]	[rpm]	VSD
B	T	1,01	1,08	54,7%	60,5	1,195	11629	187	1410	INCLUDED

* η_e (%) = Eff. (%) x Cc

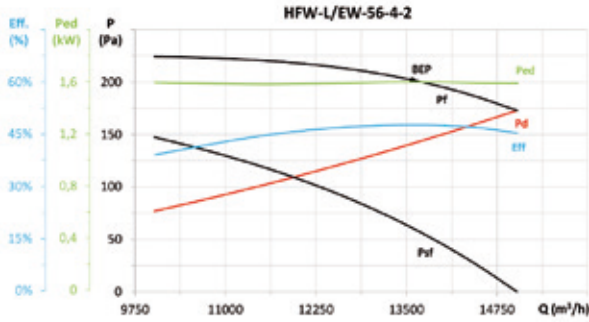

MC	EC	SR	Cc	η_e (%)*	N	[kW]	[m³/h]	[Pa]	[rpm]	VSD
B	T	1,00	1,07	53,0%	58,1	1,545	13581	202	1410	INCLUDED

* η_e (%) = Eff. (%) x Cc

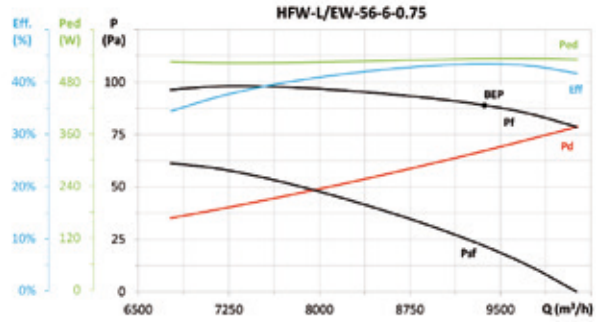

MC	EC	SR	Cc	η_e (%)*	N	[kW]	[m³/h]	[Pa]	[rpm]	VSD
B	T	1,00	1,11	49,9%	58,1	0,514	9368	89	900	INCLUDED

* η_e (%) = Eff. (%) x Cc

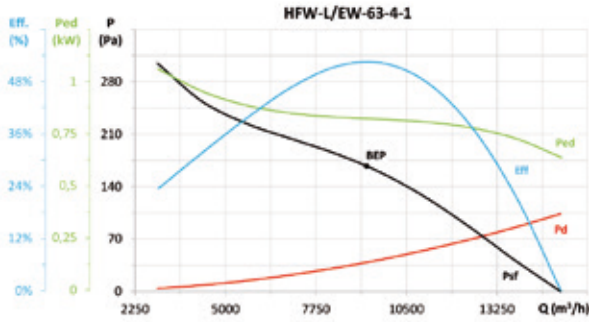

MC	EC	SR	Cc	η_e (%)*	N	[kW]	[m³/h]	[Pa]	[rpm]	VSD
C	S	1,00	1,09	57,4%	64,3	0,822	9291	167	1410	INCLUDED

* η_e (%) = Eff. (%) x Cc

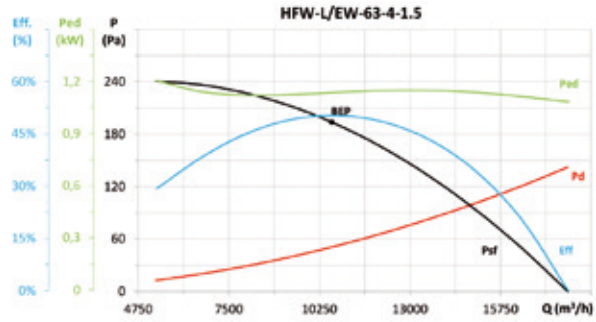

MC	EC	SR	Cc	η_e (%)*	N	[kW]	[m³/h]	[Pa]	[rpm]	VSD
C	S	1,00	1,08	54,5%	60,5	1,136	10625	194	1410	INCLUDED

* η_e (%) = Eff. (%) x Cc

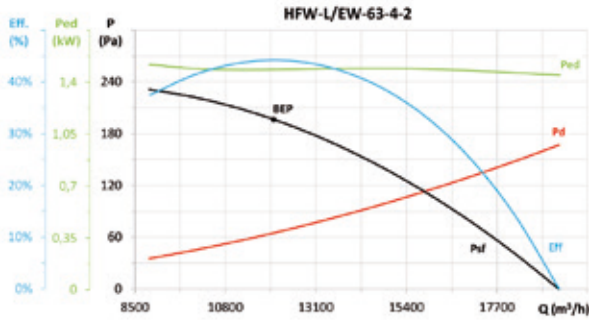

MC	EC	SR	Cc	η_e (%)*	N	[kW]	[m³/h]	[Pa]	[rpm]	VSD
C	S	1,00	1,08	47,5%	52,8	1,485	12026	196	1410	INCLUDED

* η_e (%) = Eff. (%) x Cc

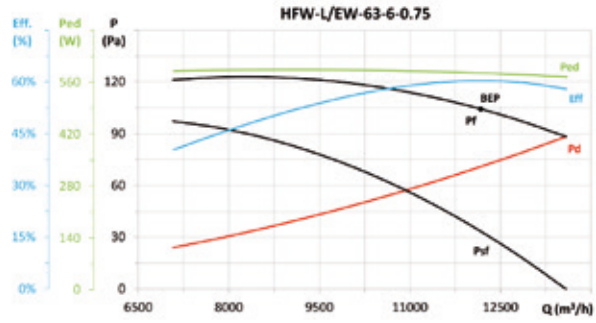

MC	EC	SR	Cc	η_e (%)*	N	[kW]	[m³/h]	[Pa]	[rpm]	VSD
B	T	1,00	1,11	69,2%	77,1	0,563	12174	104	900	INCLUDED

* η_e (%) = Eff. (%) x Cc



ErP. Characteristic Curves and ErP Data

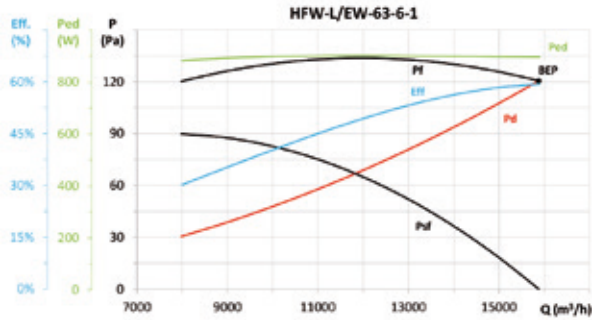

MC	EC	SR	Cc	η_e (%)*	N	[kW]	[m³/h]	[Pa]	[rpm]	VSD
B	T	1,00	1,09	66,6%	73,4	0,871	15880	121	900	INCLUDED

* η_e (%) = Eff. (%) x Cc

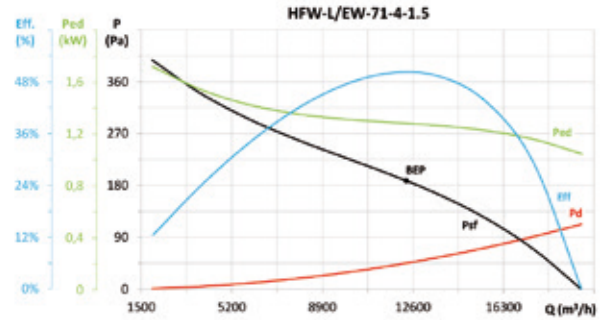

MC	EC	SR	Cc	η_e (%)*	N	[kW]	[m³/h]	[Pa]	[rpm]	VSD
C	S	1,00	1,08	54,3%	59,9	1,282	12330	188	1410	INCLUDED

* η_e (%) = Eff. (%) x Cc

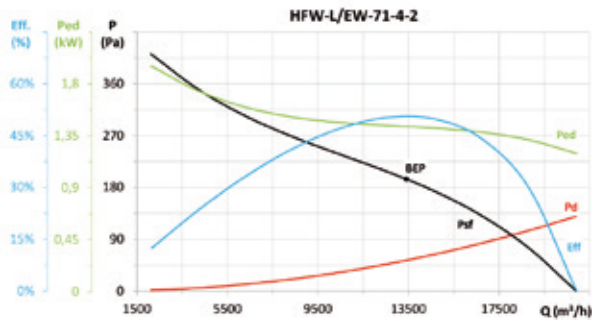

MC	EC	SR	Cc	η_e (%)*	N	[kW]	[m³/h]	[Pa]	[rpm]	VSD
C	S	1,00	1,08	54,4%	59,8	1,432	13405	195	1410	INCLUDED

* η_e (%) = Eff. (%) x Cc

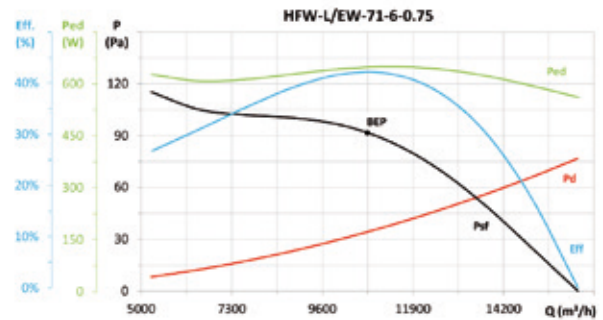

MC	EC	SR	Cc	η_e (%)*	N	[kW]	[m³/h]	[Pa]	[rpm]	VSD
C	S	1,00	1,10	48,2%	55,8	0,625	10743	92	900	INCLUDED

* η_e (%) = Eff. (%) x Cc

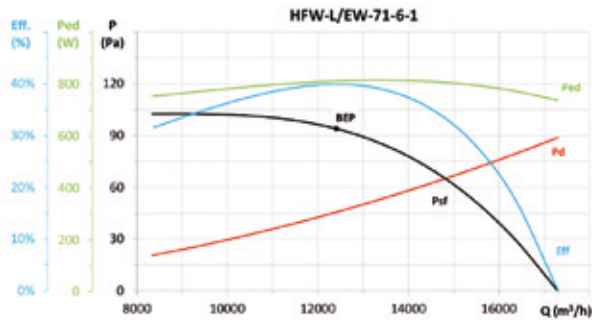

MC	EC	SR	Cc	η_e (%)*	N	[kW]	[m³/h]	[Pa]	[rpm]	VSD
C	S	1,00	1,10	44,9%	51,9	0,789	12404	94	900	INCLUDED

* η_e (%) = Eff. (%) x Cc

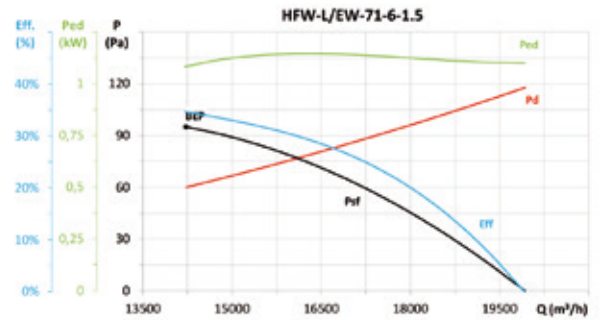

MC	EC	SR	Cc	η_e (%)*	N	[kW]	[m³/h]	[Pa]	[rpm]	VSD
C	S	1,00	1,09	38,5%	44,7	1,059	14226	95	900	INCLUDED

* η_e (%) = Eff. (%) x Cc

HFW/EW



**HIGHLY EFFICIENT
IE3-COMPLIANT
THREE-PHASE
MOTORS**

**Cased axial fans with high efficiency,
IE3 asynchronous motors.
Electronically speed controlled by variable
speed drive.**

Cased axial fans with pad mounted motors and mounting arms designed to reduce noise and vibration. The aluminium impellers are aerodynamically designed to improve efficiency. Together with the high efficiency IE3 motors and variable speed drive.



VARIABLE SPEED DRIVE
VSD: Variable Speed Drive.
VSD1/A-RFM
VSD3/A-RFT
Available on order

CONTROL
Supplied as an optional accessory

SUPPLY
VSD1/A-RFM:
220-240 V 50/60 Hz
VSD3/A-RFT:
380-415 V 50/60 Hz

Fan:

- Airflow direction from motor to impeller
- Cast aluminium impellers
- Sheet steel casing with double flange and cable gland
- Steel galvanised case

Motor and electronic variable drive:

- Motors with IE3 efficiency adjustable electronically
- The variable speed drive VSD is available on request
- Electronic variable speed drive (VSD) can be adjusted by external 0-10 V signal
- The external signal can be supplied through a manual or automatic control with 0-10 V output.
- Sinusoidal filters are recommended to be fitted between the fan and the VSD where there are installations with long cable lengths
- Electronic variable speed drives (VSD's) are available with single-phase 220-240V 50/60Hz input (VSD1/A-RFM) or three-phase 380-415V 50/60Hz (VSD3/A-RFM type). Standard IP20

protection up to 15hp (11kW), IP55 for higher powers. IP66 protection up to 10hp(7.5kW) available on request

- By default, the electronic variable speed drive (VSD) is delivered programmed for constant speed
- Fan working temperature: -25 °C +50 °C.
- VSD working temperature: -25 °C +50 °C.
- Class F motors with ball bearings, IP55 protection
- Three-phase 230/400V, 50Hz up to and including 5.5hp (4kW) and 400/690V, 50Hz power over 5.5hp (4kW)

Finish:

- Hot-galvanised

Available on request:

- Airflow direction from impeller to motor
- PL version impellers - made from glass fibre reinforced polyamide
- 100% reversible impellers

Order Code

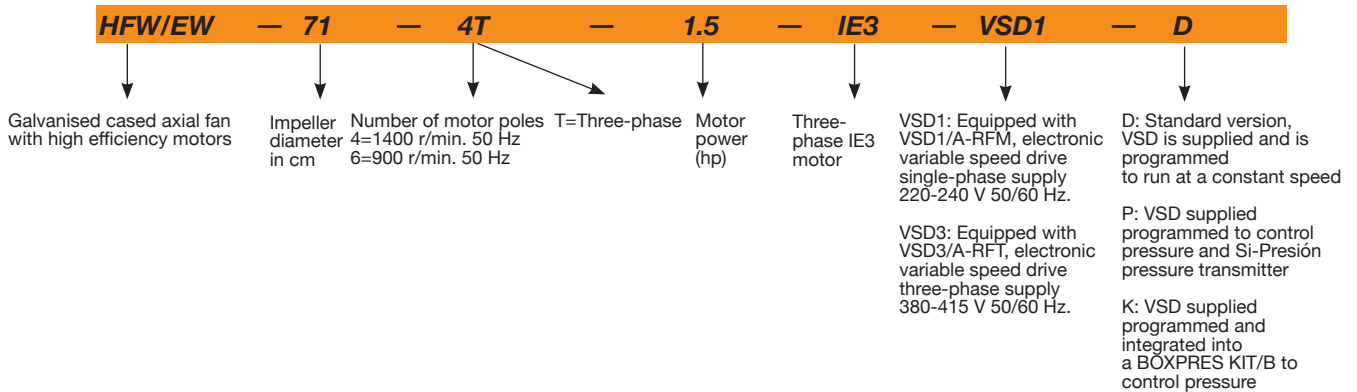

Technical Characteristics

Model	Speed min/max (r/min)	Single-phase VSD 230 V 50/60 Hz		Three-phase VSD 400 V 50/60 Hz		Maximum Motor 50 Hz			Installed power (kW)	Maximum Airflow min/max (m³/h)	Sound pressure level min/max dB(A)	Approx. Weight (Kg)
		Maximum input current (A)	Model VSD	Maximum input current (A)	Model VSD	230V	400V	690V				
HFW/EW-63-4T-3	575/1435	23.15	VSD1/A-RFM-3	6.43	VSD3/A-RFT-3	7.93	4.56	-	2.20	8875 / 22150	56 / 76	43
HFW/EW-63-4T-4	575/1440	-	-	7.20	VSD3/A-RFT-5.5	10.70	6.15	-	3.00	9685 / 24250	57 / 77	45
HFW/EW-71-4T-3	575/1435	23.15	VSD1/A-RFM-3	6.43	VSD3/A-RFT-3	7.93	4.56	-	2.20	10055 / 25100	61 / 81	47
HFW/EW-71-4T-4	575/1440	-	-	7.20	VSD3/A-RFT-5.5	10.70	6.15	-	3.00	10980 / 27500	62 / 82	49
HFW/EW-80-4T-3	575/1435	23.15	VSD1/A-RFM-3	6.43	VSD3/A-RFT-3	7.93	4.56	-	2.20	10200 / 25450	62 / 82	55
HFW/EW-80-4T-4	575/1440	-	-	7.20	VSD3/A-RFT-5.5	10.70	6.15	-	3.00	12080 / 30250	63 / 83	57
HFW/EW-80-4T-5.5	580/1450	-	-	9.48	VSD3/A-RFT-5.5	13.90	8.00	-	4.00	13100 / 32750	64 / 84	62
HFW/EW-80-6T-1.5	380/945	12.43	VSD1/A-RFM-2	3.45	VSD3/A-RFT-2	4.68	2.69	-	1.10	8625 / 21450	52 / 72	48
HFW/EW-80-6T-2	380/950	16.64	VSD1/A-RFM-2	4.62	VSD3/A-RFT-2	6.43	3.70	-	1.50	10380 / 25950	53 / 73	54
HFW/EW-80-6T-3	380/950	23.83	VSD1/A-RFM-3	6.62	VSD3/A-RFT-3	9.08	5.22	-	2.20	11980 / 29950	54 / 74	59
HFW/EW-90-4T-4	575/1440	-	-	7.20	VSD3/A-RFT-5.5	10.70	6.15	-	3.00	13415 / 33600	67 / 87	66
HFW/EW-90-4T-5.5	580/1450	-	-	9.48	VSD3/A-RFT-5.5	13.90	8.00	-	4.00	15560 / 38900	69 / 89	71
HFW/EW-90-4T-7.5	585/1465	-	-	12.81	VSD3/A-RFT-7.5	-	10.30	5.97	5.50	18430 / 46150	71 / 91	87

Technical Characteristics

Model	Speed min/max (r/min)	Single-phase VSD 230 V 50/60 Hz		Three-phase VSD 400 V 50/60 Hz		Maximum Maximum Motor 50 Hz			Installed power (kW)	Maximum Airflow min/max (m³/h)	Sound pressure level min/max dB(A)	Approx. Weight (Kg)
		Maximum input current (A)	Model VSD	Maximum input current (A)	Model VSD	230V	400V	690V				
HFW/EW-90-4T-10	585/1465	-	-	17.32	VSD3/A-RFT-10	-	13.90	8.06	7.50	20025 / 50150	72 / 92	98
HFW/EW-90-6T-2	380/950	16.64	VSD1/A-RFM-2	4.62	VSD3/A-RFT-2	6.43	3.70	-	1.50	11520 / 28800	57 / 77	63
HFW/EW-90-6T-3	380/950	23.83	VSD1/A-RFM-3	6.62	VSD3/A-RFT-3	9.08	5.22	-	2.20	13600 / 34000	58 / 78	68
HFW/EW-90-6T-4	390/970	-	-	7.39	VSD3/A-RFT-5.5	12.00	6.91	-	3.00	15640 / 38900	59 / 79	92
HFW/EW-100-4T-7.5	585/1465	-	-	12.81	VSD3/A-RFT-7.5	-	10.30	5.97	5.50	18710 / 46850	72 / 92	95
HFW/EW-100-4T-10	585/1465	-	-	17.32	VSD3/A-RFT-10	-	13.90	8.06	7.50	22920 / 57400	73 / 93	106
HFW/EW-100-4T-15	590/1470	-	-	25.10	VSD3/A-RFT-15	-	21.40	12.40	11.00	26610 / 66300	74 / 94	129
HFW/EW-100-4T-20	585/1465	-	-	34.41	VSD3/A-RFT-20	-	28.70	16.60	15.00	30410 / 76150	75 / 95	148
HFW/EW-100-6T-3	380/950	23.83	VSD1/A-RFM-3	6.62	VSD3/A-RFT-3	9.08	5.22	-	2.20	15040 / 37600	62 / 82	76
HFW/EW-100-6T-4	390/970	-	-	7.39	VSD3/A-RFT-5.5	12.00	6.91	-	3.00	16545 / 41150	63 / 83	100
HFW/EW-100-6T-5.5	385/960	-	-	9.74	VSD3/A-RFT-5.5	15.60	8.99	-	4.00	19170 / 47800	64 / 84	108

Acoustic Features

The specified values are determined according to free field measurements of pressure and sound levels in dB(A) at an equivalent distance of twice the fan's external diameter plus the impeller's diameter, with a minimum of 1.5 m.

Sound power Lw(A) spectrum in dB(A) via frequency band in Hz. Maximum speed

	63	125	250	500	1000	2000	4000	8000		63	125	250	500	1000	2000	4000	8000
HFW/EW-63-4T-3	53	70	78	83	85	82	77	67	HFW/EW-90-4T-7.5	59	80	87	92	95	91	84	73
HFW/EW-63-4T-4	54	71	79	84	86	83	78	68	HFW/EW-90-4T-10	58	79	86	91	94	90	83	72
HFW/EW-71-4T-3	58	72	80	85	87	84	77	71	HFW/EW-90-6T-2	58	79	86	91	94	90	83	72
HFW/EW-71-4T-4	59	73	81	86	88	85	78	72	HFW/EW-90-6T-3	56	70	77	82	85	81	74	63
HFW/EW-80-4T-3	57	77	85	90	92	89	82	73	HFW/EW-90-6T-4	57	72	79	84	87	83	76	65
HFW/EW-80-4T-4	56	76	84	89	91	88	81	74	HFW/EW-100-4T-7.5	64	84	92	97	99	96	89	78
HFW/EW-80-4T-5.5	56	76	84	89	91	88	81	70	HFW/EW-100-4T-10	62	82	90	95	97	94	87	76
HFW/EW-80-6T-1.5	49	66	74	79	81	78	71	60	HFW/EW-100-4T-15	61	81	89	94	96	93	86	75
HFW/EW-80-6T-2	50	67	75	80	82	79	72	61	HFW/EW-100-4T-20	63	83	91	96	98	95	88	77
HFW/EW-80-6T-3	51	68	76	81	83	80	73	62	HFW/EW-100-6T-3	61	72	80	85	87	84	77	66
HFW/EW-90-4T-4	61	82	89	94	97	93	86	79	HFW/EW-100-6T-4	64	72	80	85	87	84	77	66
HFW/EW-90-4T-5.5	60	81	88	93	96	92	85	74	HFW/EW-100-6T-5.5	64	73	81	86	88	85	78	67

Dimensions in mm

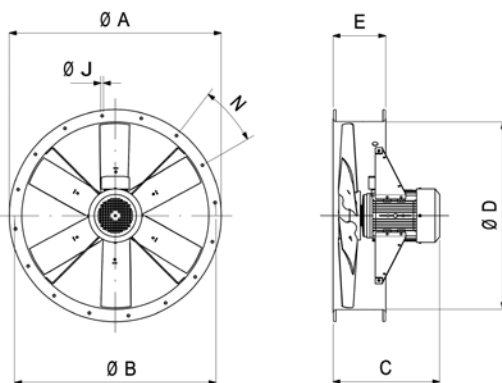

Model	ØA	ØB	C								ØD	E	ØJ	N	
			1.5	2	3	4	5.5	7.5	10	15					20
HFW/EW-63-4	735	690	-	-	470	470	-	-	-	-	-	640	225	12	12x30°
HFW/EW-71-4	815	770	-	-	430	430	-	-	-	-	-	710	225	12	16x22°30'
HFW/EW-80-4	905	860	-	-	436	436	460	-	-	-	-	800	225	12	16x22°30'
HFW/EW-80-6	905	860	395	436	460	-	-	-	-	-	-	800	225	12	16x22°30'
HFW/EW-90-4	1018	970	-	-	401	425	485	525	-	-	-	900	225	15	16x22°30'
HFW/EW-90-6	1018	970	-	401	425	485	-	-	-	-	-	900	225	15	16x22°30'
HFW/EW-100-4	1118	1070	-	-	-	-	488	528	643	703	1000	225	15	16x22°30'	
HFW/EW-100-6	1118	1070	-	-	428	488	528	-	-	-	-	1000	225	15	16x22°30'

Accessories

See accessories section.





ErP. Characteristic Curves and ErP Data

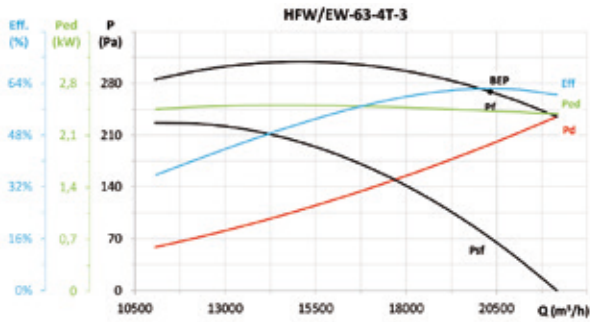

MC	EC	SR	Cc	η_b (%)*	N	[kW]	[m³/h]	[Pa]	[rpm]	VSD
B	T	1,00	1,06	66,2%	70,1	2,428	20324	269	1439	NECESSARY

* η_e (%) = Eff. (%) x Cc

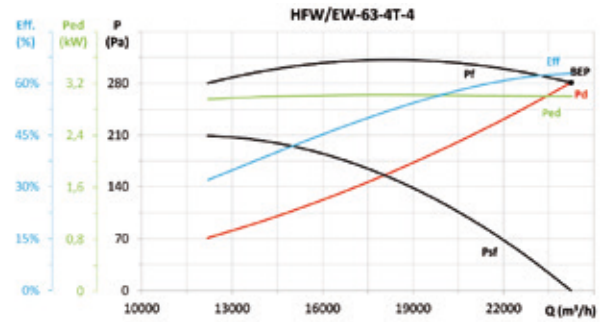

MC	EC	SR	Cc	η_b (%)*	N	[kW]	[m³/h]	[Pa]	[rpm]	VSD
B	T	1,00	1,06	66,4%	69,7	3,004	24239	281	1461	NECESSARY

* η_e (%) = Eff. (%) x Cc

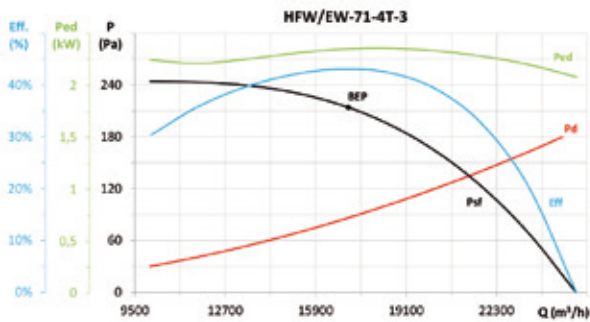

MC	EC	SR	Cc	η_b (%)*	N	[kW]	[m³/h]	[Pa]	[rpm]	VSD
C	S	1,00	1,06	45,8%	49,8	2,351	17056	214	1441	NECESSARY

* η_e (%) = Eff. (%) x Cc

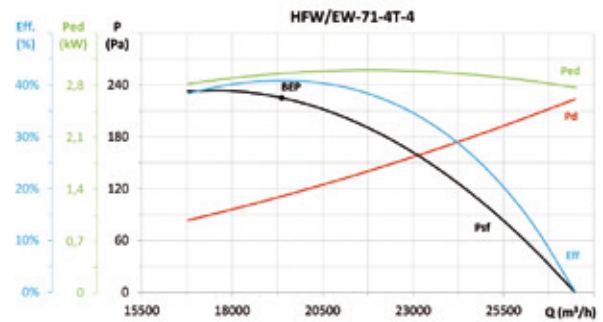

MC	EC	SR	Cc	η_b (%)*	N	[kW]	[m³/h]	[Pa]	[rpm]	VSD
C	S	1,00	1,06	43,2%	46,5	2,960	19369	225	1462	NECESSARY

* η_e (%) = Eff. (%) x Cc

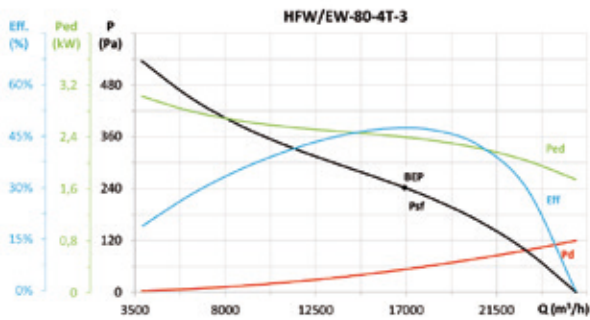

MC	EC	SR	Cc	η_b (%)*	N	[kW]	[m³/h]	[Pa]	[rpm]	VSD
C	S	1,00	1,06	50,3%	54,3	2,398	16923	242	1440	NECESSARY

* η_e (%) = Eff. (%) x Cc

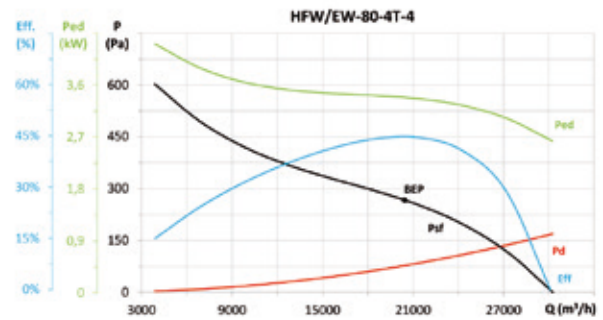

MC	EC	SR	Cc	η_b (%)*	N	[kW]	[m³/h]	[Pa]	[rpm]	VSD
C	S	1,00	1,05	47,0%	50,0	3,386	20444	267	1456	NECESSARY

* η_e (%) = Eff. (%) x Cc

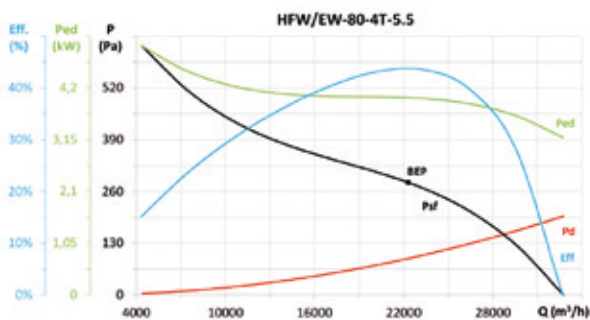

MC	EC	SR	Cc	η_b (%)*	N	[kW]	[m³/h]	[Pa]	[rpm]	VSD
C	S	1,00	1,05	45,7%	48,2	4,001	22304	282	1457	NECESSARY

* η_e (%) = Eff. (%) x Cc

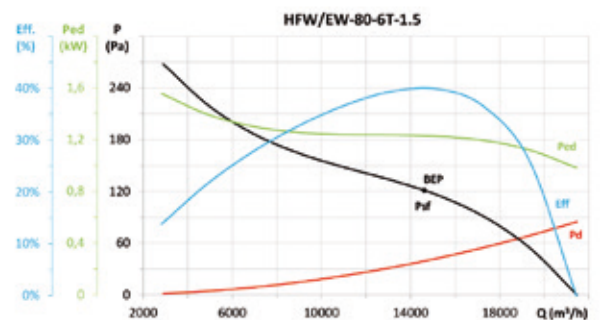

MC	EC	SR	Cc	η_b (%)*	N	[kW]	[m³/h]	[Pa]	[rpm]	VSD
C	S	1,00	1,08	44,2%	50,0	1,204	14613	121	913	NECESSARY

* η_e (%) = Eff. (%) x Cc



ErP. Characteristic Curves and ErP Data

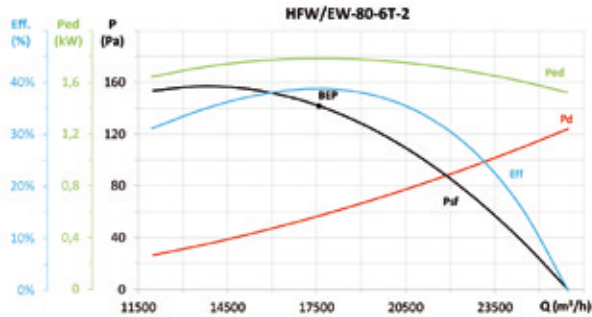

MC	EC	SR	Cc	η_b (%)*	N	[kW]	[m³/h]	[Pa]	[rpm]	VSD
C	S	1,00	1,07	42,6%	47,4	1,741	17576	142	953	NECESSARY

* η_e (%) = Eff. (%) x Cc

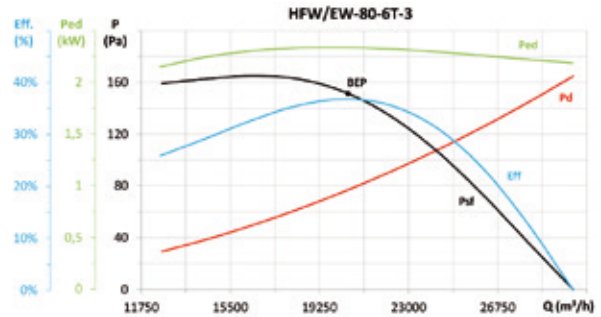

MC	EC	SR	Cc	η_b (%)*	N	[kW]	[m³/h]	[Pa]	[rpm]	VSD
C	S	1,00	1,06	39,8%	43,9	2,295	20444	151	957	NECESSARY

* η_e (%) = Eff. (%) x Cc

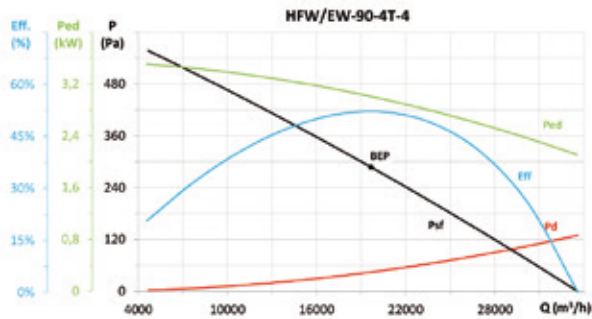

MC	EC	SR	Cc	η_b (%)*	N	[kW]	[m³/h]	[Pa]	[rpm]	VSD
C	S	1,00	1,05	55,0%	58,3	3,012	19656	288	1461	NECESSARY

* η_e (%) = Eff. (%) x Cc

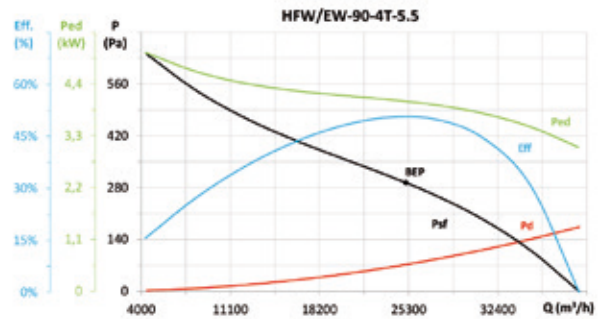

MC	EC	SR	Cc	η_b (%)*	N	[kW]	[m³/h]	[Pa]	[rpm]	VSD
C	S	1,00	1,05	53,0%	55,5	4,038	25081	294	1456	NECESSARY

* η_e (%) = Eff. (%) x Cc

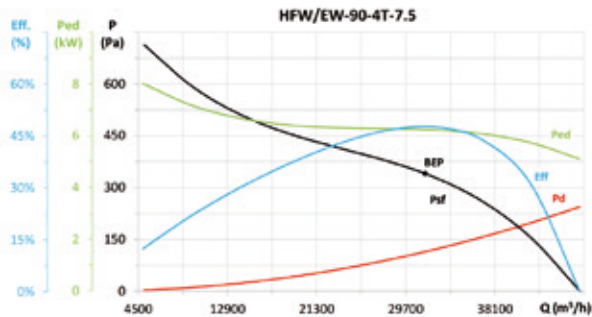

MC	EC	SR	Cc	η_b (%)*	N	[kW]	[m³/h]	[Pa]	[rpm]	VSD
C	S	1,00	1,04	49,6%	50,9	6,243	31521	341	1465	NECESSARY

* η_e (%) = Eff. (%) x Cc

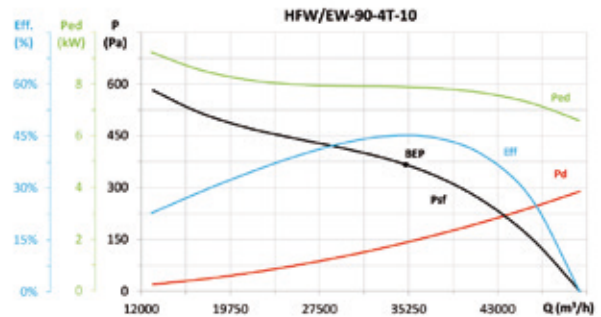

MC	EC	SR	Cc	η_b (%)*	N	[kW]	[m³/h]	[Pa]	[rpm]	VSD
C	S	1,01	1,04	46,9%	47,6	7,888	35009	367	1467	NECESSARY

* η_e (%) = Eff. (%) x Cc

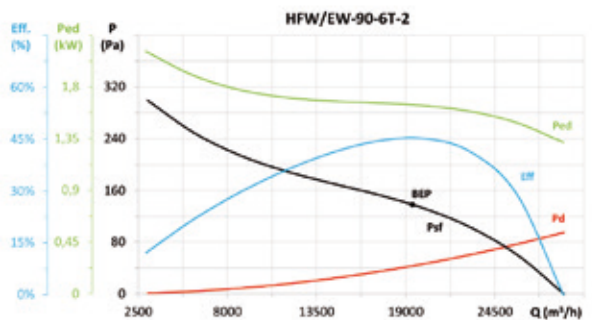

MC	EC	SR	Cc	η_b (%)*	N	[kW]	[m³/h]	[Pa]	[rpm]	VSD
C	S	1,00	1,07	49,8%	54,9	1,604	19416	138	957	NECESSARY

* η_e (%) = Eff. (%) x Cc

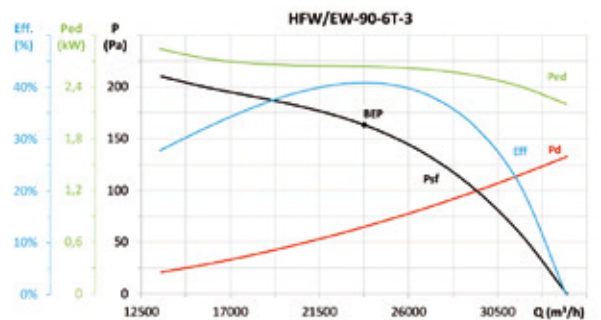

MC	EC	SR	Cc	η_b (%)*	N	[kW]	[m³/h]	[Pa]	[rpm]	VSD
C	S	1,00	1,06	44,0%	47,8	2,589	23753	163	951	NECESSARY

* η_e (%) = Eff. (%) x Cc



ErP. Characteristic Curves and ErP Data

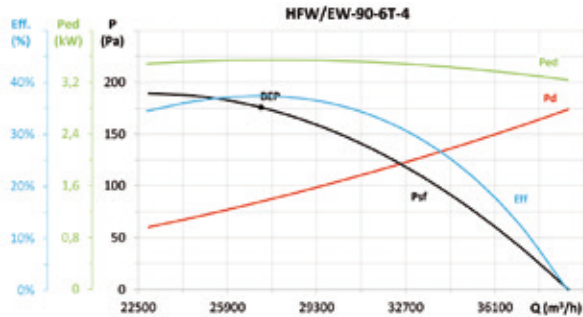

MC	EC	SR	Cc	η_b (%) [*]	N	[kW]	[m³/h]	[Pa]	[rpm]	VSD
C	S	1,00	1,05	39,9%	42,8	3,491	27183	176	971	NECESSARY

* η_e (%) = Eff. (%) x Cc

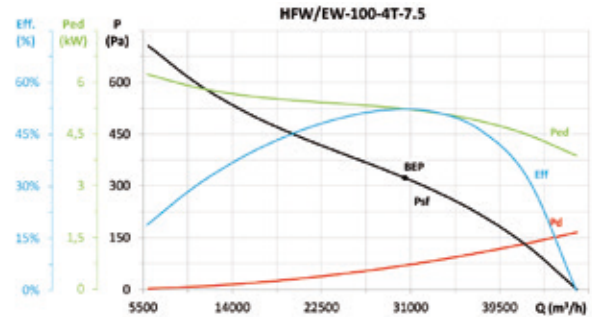

MC	EC	SR	Cc	η_b (%) [*]	N	[kW]	[m³/h]	[Pa]	[rpm]	VSD
C	S	1,00	1,04	54,3%	56,1	5,233	30466	323	1471	NECESSARY

* η_e (%) = Eff. (%) x Cc

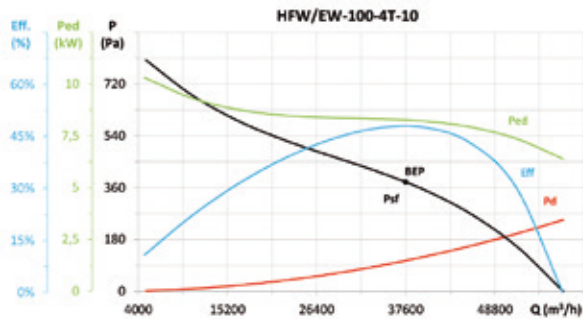

MC	EC	SR	Cc	η_b (%) [*]	N	[kW]	[m³/h]	[Pa]	[rpm]	VSD
C	S	1,00	1,04	49,8%	50,3	8,278	37591	380	1466	NECESSARY

* η_e (%) = Eff. (%) x Cc

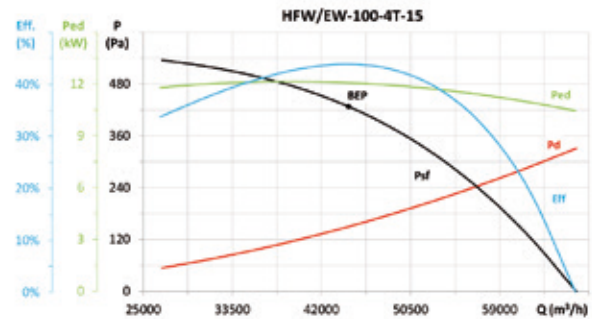

MC	EC	SR	Cc	η_b (%) [*]	N	[kW]	[m³/h]	[Pa]	[rpm]	VSD
C	S	1,01	1,04	45,6%	45,5	12,083	44571	428	1470	NECESSARY

* η_e (%) = Eff. (%) x Cc

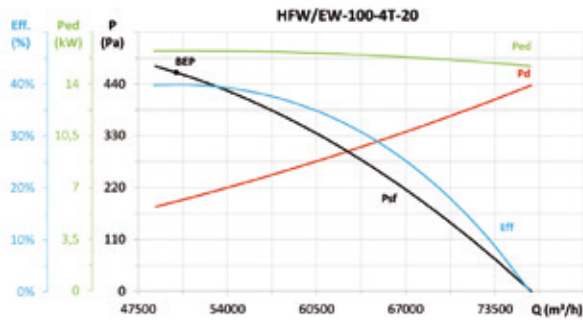

MC	EC	SR	Cc	η_b (%) [*]	N	[kW]	[m³/h]	[Pa]	[rpm]	VSD
C	S	1,01	1,04	41,5%	41,2	16,247	50259	465	1466	NECESSARY

* η_e (%) = Eff. (%) x Cc

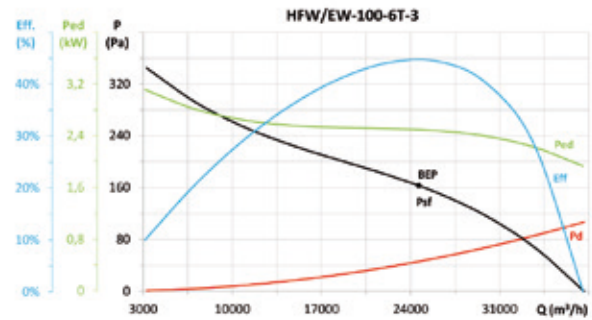

MC	EC	SR	Cc	η_b (%) [*]	N	[kW]	[m³/h]	[Pa]	[rpm]	VSD
C	S	1,00	1,06	48,3%	52,1	2,450	24629	163	954	NECESSARY

* η_e (%) = Eff. (%) x Cc

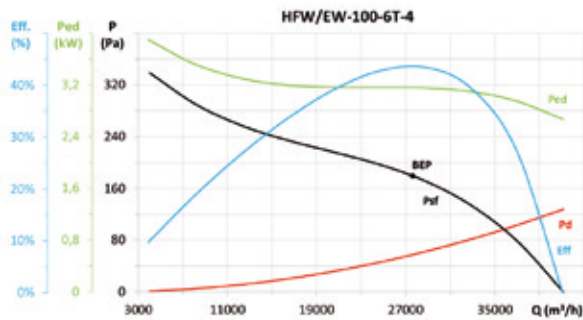

MC	EC	SR	Cc	η_b (%) [*]	N	[kW]	[m³/h]	[Pa]	[rpm]	VSD
C	S	1,00	1,05	46,6%	49,8	3,109	27632	179	974	NECESSARY

* η_e (%) = Eff. (%) x Cc

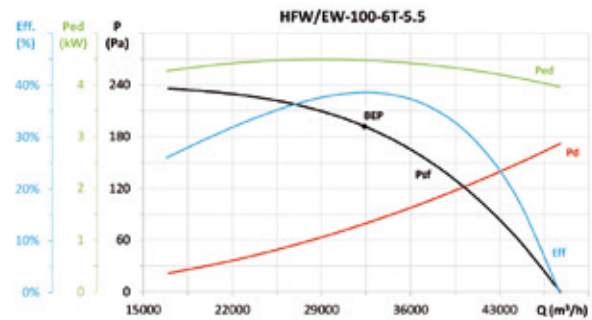

MC	EC	SR	Cc	η_b (%) [*]	N	[kW]	[m³/h]	[Pa]	[rpm]	VSD
C	S	1,00	1,04	40,8%	43,1	4,404	32373	192	963	NECESSARY

* η_e (%) = Eff. (%) x Cc

EFFICIENT WORK FANS



SOLution DEvelopment CAPacity

Fast and flexible industrial fan solutions and tailored fans

Large experience in smoke control systems and ATEX applications

Wide range of certified products for specific markets

AXIAL
FANS AND
ROOF FANS



CENTRIFUGAL
FANS AND IN-LINE



FANS FOR
SMOKE
EXTRACTION



ATEX FANS FOR EXPLOSIVE
ATMOSPHERES AND OTHER
APPLICATIONS



HEAT RECOVERY
SYSTEMS AND
FILTRATION UNITS



AIR CURTAINS FOR
COMMERCIAL AND
INDUSTRIAL APPLICATIONS



VENTILATION SYSTEMS
FOR
HOUSES



REQUEST FURTHER INFORMATION

www.sodeca.com



Distributed by:



SODECA
Ctra. de Berga, km 0,7
E-08580 SANT QUIRZE
DE BESORA
Barcelona - SPAIN
Tel. +34 93 852 91 11
Fax +34 93 852 90 42
ventilation@sodeca.com



PORTUGAL
Sodeca Portugal Lda
Luiz Araújo
Rua Veloso Salgado 1120/1138
4450-801 LEÇA DE PALMEIRA
PORTUGAL
Tel. +351 229 991 100
Fax. +351 229 991 119
geral@decflex.com

FINLAND
Sodeca Finland Oy
Mr. Kai Yli-Sipila
Metsälinnankatu 30, PL2,
FI-32700 HUITTINEN, FINLAND
Tel. + 358 2255 7582
orders.finland@sodeca.com

CHILE
Sodeca Ventiladores Ltda
Sr. Francesc Bertran
Avda. Puerta Sur 03380
San Bernardo, SANTIAGO,
CHILE
Tel. +56 (02) 2840 5582
ventas.chile@sodeca.com

ÁREA CARIBE
Residencial Miramar Apto. Nº 108
Ave. 7ma Nº 1805 entre 18 y 20.
Miramar Playa,
CIUDAD DE LA HABANA, CUBA
Tel. 00537 20 43721
sodeca@sodeca.co.cu