

Datasheet - BPS 33

Safety sensors / BNS 33 / Actuator

 Preferred typ

(Minor differences between the printed image and the original product may exist!)

Ordering details

Product type description	BPS 33
Article number	101107771
EAN Code	4030661272849
eCl@ss	27-27-92-17

Global Properties

Permanent light	Magnet
Materials	
- Material of the housings	Plastic
Weight	25

Dimensions

Dimensions of the actuators	
- Width of the actuator	88
- Height of the actuator	25
- Length of the actuator	13

Included in delivery

tamperproof screws	2 piece
--------------------	---------

Images

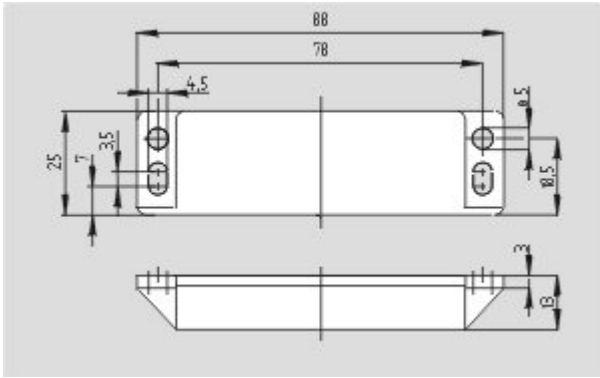

Dimensional drawing (miscellaneous)

K.A. Schmersal GmbH & Co. KG, Möddinghofe 30, D-42279 Wuppertal

The data and values have been checked thoroughly. Technical modifications and errors excepted.

Generiert am 20.09.2019 - 15:27:47h Kasbase 3.3.0.F.64I