

ADC5000 SERIES

AC/DC Switch Mode Power Supplies and Rectifiers for Industrial and Telecom Applications



60W, 125W and 250 W

- Input voltage 230/115 VAC • Output voltages 12, 24, 36 or 48 VDC • Statistical MTBF >3 000 000 hours
- Built in output series diode • Temperature compensated battery charging • Wide output adjustment range
- Efficiency 82...90% • Operating temperature -40 °C...+70 °C (see derating) • EMC EN55022B (telecom)

MULTI PURPOSE APPLICATIONS (EXAMPLES)

(A)

(B)

(C)

(D)

Battery back-up systems
Temperature compensated charging
Low voltage disconnecting unit

Special features with external control:

- Boost charging
- Battery test possibility
- Shut down by external 4-15V voltage
- Controllable output voltage

Redundant n+1 systems with built in series diode and module fail

Series connection ± Outputs

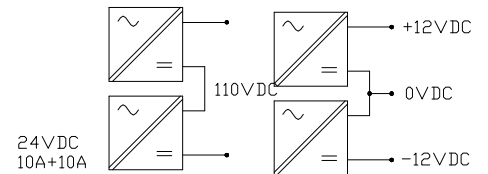
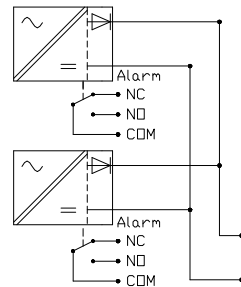
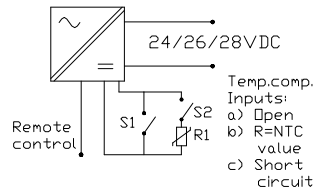
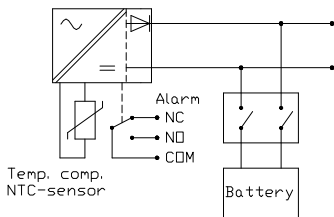

Sales & R&D Martinkyläntie 43, FI-01720 VANTAA, Tel. +358 10 2890 700
E-mail marketing@powernet.fi, service@powernet.fi
Internet www.powernet.fi

POWER SUPPLY MODELS DIN/WALL								
Type *) <u>xy</u> see below	Available <u>xy</u> selection codes (others on request)	Input Voltage	Output Voltage	Output Voltage Adjustment	Output Current	Power	Mechanical Dimensions (W x H x D)	Note see below
ADC56 <u>xy</u>	<u>xy</u> = 23, 33	90...264 VAC	12 VDC	10.5...15 VDC	5 A	60 W	51 x 121 x 81 mm	
ADC50 <u>xy</u>	On request	230/115 VAC	12 VDC	9...15 VDC	10 A	120 W	66 x 148 x 113 mm	
ADC53 <u>xy</u>	<u>xy</u> = 23	230/115 VAC	12 VDC	9...15 VDC	20/18 A	240 W	75 x 173 x 122 mm	**) (***)
ADC53 <u>xy</u> P	On request	230/115 VAC	12 VDC	9...15 VDC	20/18 A	240 W	75 x 173 x 122 mm	***)
ADC57 <u>xy</u>	<u>xy</u> = 21, 23	90...264 VAC	24 VDC	21...29 VDC	2.5 A	60 W	51 x 121 x 81 mm	
ADC51 <u>xy</u>	<u>xy</u> = 21, 23, 31	230/115 VAC	24 VDC	21...29 VDC	5 A	120 W	66 x 148 x 113 mm	
ADC54 <u>xy</u>	<u>xy</u> = 21, 23	230/115 VAC	24 VDC	21...29 VDC	10 A	240 W	75 x 173 x 122 mm	**)
ADC54 <u>xy</u> P	On request	230/115 VAC	24 VDC	21...29 VDC	10 A	240 W	75 x 173 x 122 mm	
ADC59 <u>xy</u>	On request	90...264 VAC	36 VDC	33...44 VDC	1.7 A	60 W	51 x 121 x 81 mm	***)
ADC58 <u>xy</u>	On request	90...264 VAC	48 VDC	45...58 VDC	1.25 A	60 W	51 x 121 x 81 mm	
ADC52 <u>xy</u>	On request	230/115 VAC	48 VDC	45...58 VDC	2.5 A	120 W	66 x 148 x 113 mm	
ADC55 <u>xy</u>	<u>xy</u> = 23	230/115 VAC	48 VDC	45...58 VDC	5 A	240 W	75 x 173 x 122 mm	**)
ADC55 <u>xy</u> P	On request	230/115 VAC	48 VDC	45...58 VDC	5 A	240 W	75 x 173 x 122 mm	
8750230A	Finger protected power cord for ADC5000-series models							

RECTIFIER MODELS DIN/WALL, FLOAT OUTPUT VOLTAGE LEVEL (See Application (A) page 1)								
Type *) <u>xy</u> see below	Available <u>xy</u> selection codes (others on request)	Input Voltage	Output Voltage	Output Voltage Adjustment	Output Current	Power	Mechanical Dimensions (W x H x D)	Note see below
ADC56 <u>xy</u>	<u>xy</u> = 81, 83	90...264 VAC	13.7 VDC	10.5...15 VDC	4.4 A	60 W	51 x 121 x 81 mm	
ADC50 <u>xy</u>	<u>xy</u> = 81, 83	230/115 VAC	13.7 VDC	9...15 VDC	10 A	137 W	66 x 148 x 113 mm	
ADC53 <u>xy</u>	<u>xy</u> = 83	230/115 VAC	13.7 VDC	9...15 VDC	20/18 A	274 W	75 x 173 x 122 mm	**) (***)
ADC53 <u>xy</u> P	On request	230/115 VAC	13.7 VDC	9...15 VDC	20/18 A	274 W	75 x 173 x 122 mm	***)
ADC57 <u>xy</u>	<u>xy</u> = 83	90...264 VAC	27.4 VDC	21...29 VDC	2.2 A	60 W	51 x 121 x 81 mm	
ADC51 <u>xy</u>	<u>xy</u> = 81, 83	230/115 VAC	27.4 VDC	21...29 VDC	5 A	137 W	66 x 148 x 113 mm	
ADC54 <u>xy</u>	<u>xy</u> = 81, 83	230/115 VAC	27.4 VDC	21...29 VDC	10 A	274 W	75 x 173 x 122 mm	**)
ADC54 <u>xy</u> P	<u>xy</u> = 85	230/115 VAC	27.4 VDC	21...29 VDC	10 A	274 W	75 x 173 x 122 mm	
ADC59 <u>xy</u>	On request	90...264 VAC	41.4 VDC	33...44 VDC	1.5 A	60 W	51 x 121 x 81 mm	***)
ADC58 <u>xy</u>	On request	90...264 VAC	54.8 VDC	45...58 VDC	1.1 A	60 W	51 x 121 x 81 mm	
ADC52 <u>xy</u>	On request	230/115 VAC	54.8 VDC	45...58 VDC	2.5 A	137 W	66 x 148 x 113 mm	
ADC55 <u>xy</u>	<u>xy</u> = 83, 93	230/115 VAC	54.8 VDC	45...58 VDC	5 A	274 W	75 x 173 x 122 mm	**)
ADC55 <u>xy</u> P	On request	230/115 VAC	54.8 VDC	45...58 VDC	5 A	274 W	75 x 173 x 122 mm	
8750230A	Finger protected power cord for ADC5000-series models							

*) y selection code:

Standard features:

All models

- 1 = Module fail alarm relay + Output over voltage protection (OVP),
- 3 = Output series diode + Module fail alarm relay + Output OVP

Optional features:

125/250W models
125/250W rectifiers

- 0 = Alarm relay + Shut down, 2 = Output series diode + Alarm relay + Shut down, (No OVP)
- 4 = Output remote control for battery test + alarm relay + Output OVP,
- 5 = Output remote control for battery test + alarm relay + Output OVP + Output series diode

Letter P models include passive power factor correction coil

**) Marked model does not comply with EN61000-3-2 harmonics standard.
These can be used in following applications: the unit is not directly connected to the public mains network, or if the unit is installed in a professional equipment with a total rated power greater than 1kW, or if the input current of the equipment is greater than 16A per phase

***) Marked models are not UL508 listed, 12V/ 20A model max current with series diode 18A

Marking plate sticker

See type number and serial number details here

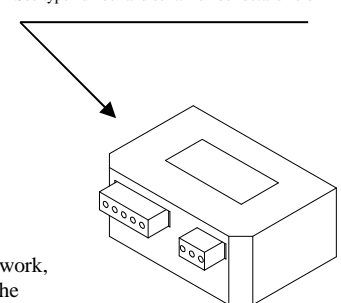

Optional: *ADC5000 R-versions for rugged environment, Type number for example ADC5183R*

SPECIFICATION

	60W				125W			250W			
	12V	24V	36V	48V	12V	24V	48V	12V	24V	48V	
INPUT											
Input voltage	90...264 VAC / 85...200 VDC (DC input is not UL60950-1 approved)				94...132 VAC or 184...264 VAC selectable by switch						
Frequency	45...65Hz										
Input current, 100% load, 230VAC	0.8A				1.4A			ADC5xxx 2.5A, ADC5xxxP 1.9A			
Input current, 100% load, 115VAC	1.4A				2.4A			ADC5xxx 4.5A			
Efficiency, typical (230 VAC, 100% load)	>82%	>83%	>83%	>84%	>85%	>88%	>89%	>85%	>89%	>90%	
Isolation	Input / ground 1500 VAC RMS 50Hz, 1min, Input / output 3000 VAC RMS 50Hz, 1min. Output / ground 500 VDC										
Inrush current (25°C), 230VAC	<25A <5ms				<45A <5ms			<35A <5ms			
Inrush current (25°C), 115VAC	<12A <10ms				<22A <10ms			<17A <10ms			
Input fuse	T3.15A, high breaking				T4A, high breaking			T6.3A, High breaking			
Overvoltage transient protection	VDR 275VAC 72J										
OUTPUT											
Output voltage, PSU models (50% load)	12V	24V	36V	48V	12V	24V	48V	12V	24V	48V	
Output voltage, rectifiers (50% load)	13.7V	27.4V	41.1V	54.8V	13.7V	27.4V	54.8V	13.7V	27.4V	54.8V	
Output adjustment (typical)	10.5...15V	21...29V	33...44V	45...58V	9...15V	21...29V	45...58V	9...15V	21...29V	45...58V	
Ripple voltage (20Hz...300kHz, 25°C)	<15mV _{rms}				<15mV _{rms}	<15mV _{rms}	<15mV _{rms}	<15mV _{rms}	<15mV _{rms}	<15mV _{rms}	
Load regulation (without series diode)	<1.0 %	<0.5 %	<0.5 %	<0.5 %	<1.0 %	<0.5 %	<0.5 %	<1.0 %	<0.5 %	<0.5 %	
Line regulation	< 0.15 %, U _{inmin} ...U _{inmax}										
Temperature coefficient	< 0.02 % / °C										
Current limit (refer curve page 5)	<8A	<4A	<3A	<2A	<11A	<6A	<3A	<22/20A	<11A	<6A	
Short circuit current (refer curve page 5)	<14A	<9A	<8A	<6A	<16A	<10A	<6A	<27A	<14A	<9A	
Hold-up time (230V, 100% load)	>50ms	>50ms	50ms	50ms	>20ms	>20ms	>20ms	>20ms	>20ms	>20ms	
ALARMS AND INDICATIONS											
Output OK	Green LED										
Power Fail relay alarm	Relay contacts Normally Open and Closed, Activated at AC fail and module fail cases Relay contact rating: 24VDC/0.3A or 30VAC/0.5A										
Undervoltage alarm threshold level	10.2V ±0.5V	20V ±1V	28V ±1V	41V ±2V	8.3V ±0.5V	19V ±1V	39V ±2V	8.3V ±0.5V	19V ±1V	39V ±2V	
Output overvoltage protection level	16V	30.5V	46V	61V	16V	31V	60V	16V	31V	60V	
Series diode at output	Output can be equipped with internal series diode, diode in 125/250W models, FET circuit in 60W models										
Optional Shutdown	Shutdown by external voltage 4...15VDC to RC pin										
Optional battery test control	Float charge voltage can be reduced by external 4...15VDC control to allow battery test by using external measurement circuit										
Temperature compensation (rectifiers)	By external NTC resistor 2.2 kohm, included in rectifier models delivery										
MECHANICAL											
Dimensions (w x h x d)	51 x 121 x 81 mm				66 x 148 x 113 mm			75 x 173 x 122 mm			
	Can be installed both horizontally and vertically (3 different installation choices)										
Weight	360 g				840 g			ADC5xxx 1.3kg, ADC5xxxP 1.5kg			
Enclosure	Steel / aluminium enclosure IP20										
Connectors	Removable 2.5 mm ² screw terminals										
ENVIRONMENTAL											
Storage temperature	-40°C...+85°C										
Operation temperature	-40°C...+70°C, full power up to +55C (expect 250W/12VDC models), See derating curves										
Cooling	Natural convection										
Humidity	85% RH 95% RH coated PCBs in R-versions Do not energize while condensation is present.										
Shock and vibration	ETS 300 019-2-4, class 4M5, Vibration, sin, IEC60068-2-6, 2g _n 9-200m/s ² , Vibration, broad-band random, IEC60068-2-64										
STANDARDS, APPROVALS											
Safety standards	EN 60950-1 class 1 including CB certificate and U.S. deviations according to UL60950-1 class 1 UL508 industrial control equipment (not all models, refer page 2)										
EMC emissions EN61000-6-3	EN 55022 class B conducted and radiated emissions EN61000-3-2 harmonics (not 250W models without P in type number) EN61000-3-3 Flickering										
EMC Immunity EN61000-6-2	EN 61000-4-2 Electrostatic Discharge EN 61000-4-3 Radiated Immunity EN 61000-4-4 Fast Transients EN 61000-4-5 Surge EN 61000-4-6 Conducted Immunity EN 61000-4-8 Power frequency magnetic field immunity EN 61000-4-11 Voltage dips and interruptions, immunity										
Approvals	CE-marking, CB certificate EN60950-1/UL60950-1, UL508 cUL listing (not all models, refer page 2)										

PIN CONFIGURATION 60W MODELS

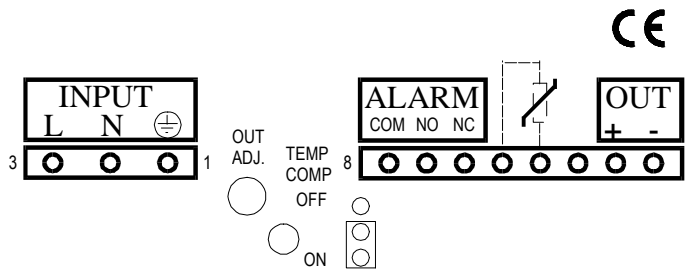

INPUT CONNECTOR

- 1: Protective Earth
- 2: N (+ if used at DC network)
- 3: L (- if used at DC network)

OUTPUT CONNECTOR

- 1: Output -
- 2: Output +
- 3: Not in use (Y selection code 1 or 3) OR Remote control input in shut down models (Y selection code 0 or 2)
- 4,5: Temperature compensation NTC sensor
- 6: Alarm relay, normally closed (relay not energized)
- 7: Alarm relay, normally open (relay not energized)
- 8: Alarm relay, common

Use 60/70 or 75°C copper (CU) wire only. The recommended terminal tightening torque is 0.5Nm.

PIN CONFIGURATION 125W MODELS

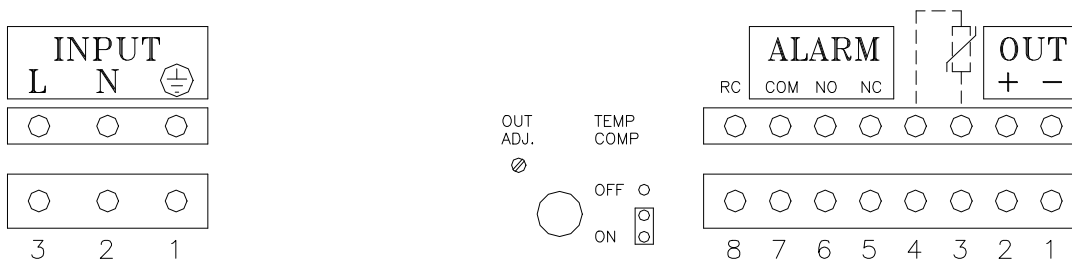

INPUT CONNECTOR

- 1: Protective Earth
- 2: N
- 3: L

OUTPUT CONNECTOR

- 1: Output -
- 2: Output +
- 3,4: Temperature compensation NTC sensor
- 5: Alarm relay, normally closed (relay not energized)
- 6: Alarm relay, normally open (relay not energized)
- 7: Alarm relay, common
- 8: Not in use (Y selection code 1 or 3) OR Remote control input in shut down (Y=0 or 2) or battery test models (Y=4 or 5)

Use 60/70 or 75°C copper (CU) wire only. The recommended terminal tightening torque is 0.5Nm.

PIN CONFIGURATION 250W MODELS

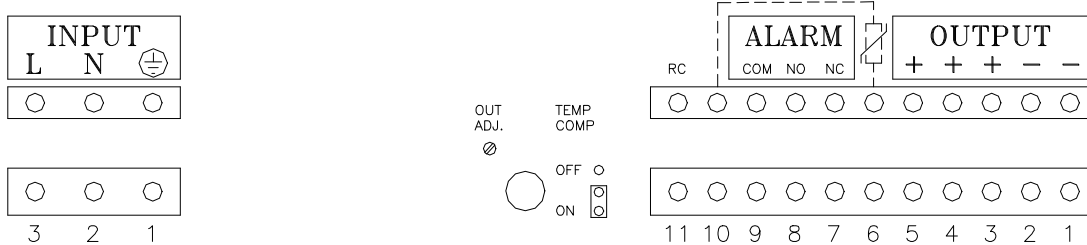

INPUT CONNECTOR

- 1: Protective Earth
- 2: N
- 3: L

OUTPUT CONNECTOR

- 1, 2: Output - Note: Rated current 12A / pin
- 3, 4, 5: Output + Note: Rated current 12A / pin
- 6: Temperature compensation NTC sensor
- 7: Alarm relay, normally closed (relay not energized)
- 8: Alarm relay, normally open (relay not energized)
- 9: Alarm relay, common
- 10: Temperature compensation NTC sensor
- 11: Not in use (Y selection code 1 or 3) OR Remote control input, shut down (Y=0 or 2) or battery test (Y=4 or 5) models

Use 60/70 or 75°C copper (CU) wire only. The recommended terminal tightening torque is 0.5Nm.

DIMENSIONS

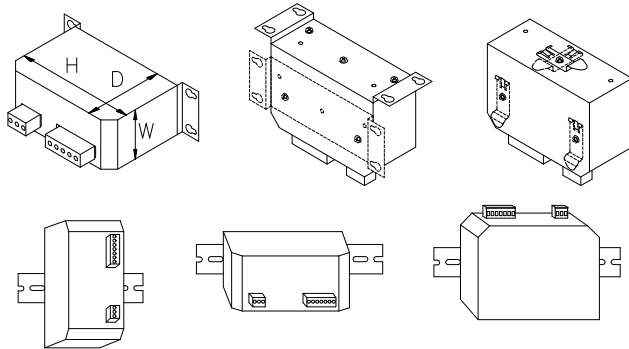

	60W	125W	250W
W	51 mm	66 mm	75 mm
H	121 mm	148 mm	173 mm
D	81 mm	113 mm	122 mm

FREE INSTALLATION CHOICE

Due to movable DIN –rail connectors 5000-series modules can be flexibly installed to the available space

CURRENT LIMITING CURVES

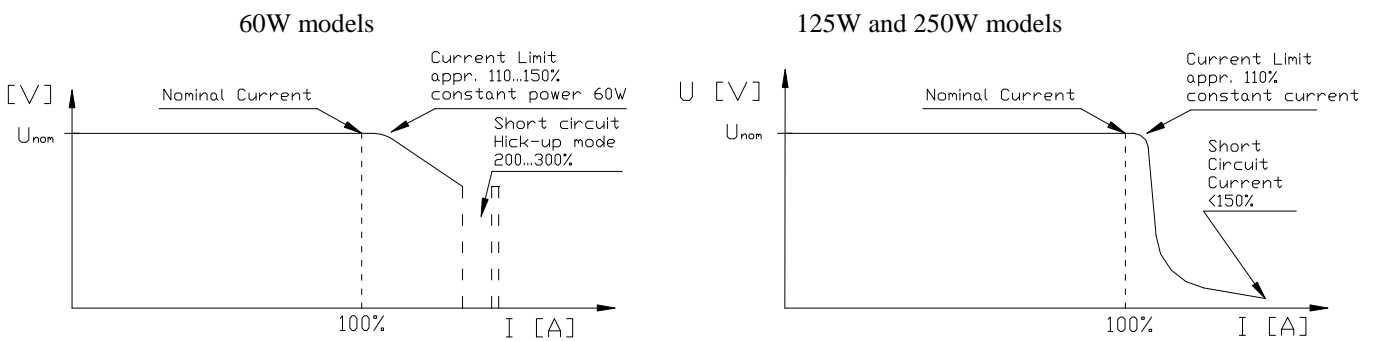

Please note that curves present the current limiting principle only. Exact values and shape of curves varies between different models, refer specification.

POWER DERATING CURVES

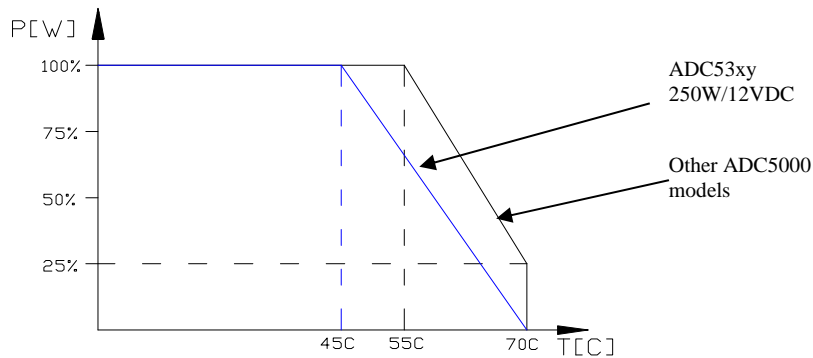

TEMPERATURE COMPENSATION EFFECT TO FLOAT CHARGE VOLTAGE

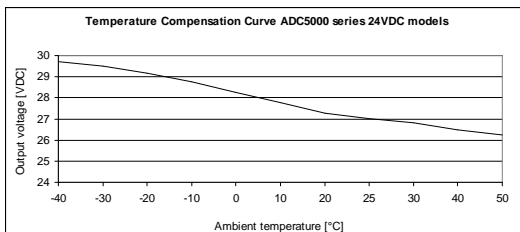
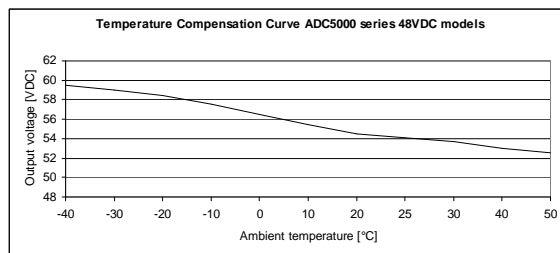
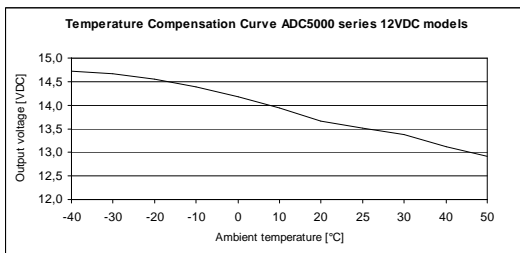

Temperature compensation sensor
2.2k ohm NTC resistor is included in rectifier models
(x =7, 8 or 9) delivery

INTENDED USE

The power supply shall only be installed and put into operation by qualified personnel.

This power supply is designed for building purposes in an enclosure and is intended to be used in industrial and telecom applications. Units can be used as a power supply or for float charging batteries in standby battery back-up solutions. For safety reasons external fuse or circuit breaker must be installed between the rectifier and battery.

R-version units also fulfill demanding environmental requirements like shocks, vibration, humidity and wide ambient temperature range. 250W units without P in the end of type number do not comply with EN61000-3-2 harmonics standard. These units are intended to be used in non-public networks only.

SAFETY PRECAUTIONS

Do not use the unit without proper earth connection (Protective Earth). Turn power off from AC input wires before working with the power supply. Units are intended to be used as permanently connected equipment (excluding bench models with fixed power cord). Readily accessible disconnection device shall be incorporated in building installation wiring. If unit is used for charging batteries, external fuse or circuit breaker must be installed between the rectifier and battery.

WARNING!

Dangerous voltages, capable of causing death, are present in this equipment. Do not remove the cover. No operator serviceable parts inside. Refer servicing to qualified service personnel.

115/230V INPUT VOLTAGE SELECTION125/250W models:

The unit is factory set to operate with a 230V nominal input voltage. The nominal input voltage can be selected via the internal 115/230 voltage selector on the PCB. Access to the selector is through the ventilation holes of the unit cover. **Always disconnect power before selecting.**

60W models:

The unit is wide input type and will work without modification from 90VAC to 264VAC.

USING UNIT WITH DC INPUT

60W units can be operated also by DC input voltage. See voltage range from specification and connection from pin configuration.

Note! DC input is not UL60950-1 approved.

OUTPUT VOLTAGE ADJUSTMENT AND BATTERY CHARGING APPLICATIONS

The output voltage of the module can be adjusted with the multi-turn potentiometer located on the front panel. All models can be used either as a power supply or a standby battery charger by correct adjustment. Please note that the output of the unit **is not reverse voltage protected** and wrong battery polarity will break the unit. So pay attention to the correct polarity.

Note! For safety reasons external fuse or circuit breaker must be installed between the rectifier and battery.

125W and 250W models: Maximum output current is available within the full voltage adjustment range.

60W models: Maximum output power is available within the full voltage adjustment range

ALARM RELAY

The potential free alarm output indicates if the output of the unit is healthy. Alarm relay contacts, both normally open and normally closed, are presented on the unit connector. If the output is healthy, the NO and COM pins are short circuited. If the unit fails the relay contacts will changeover and NC and COM pins will be short circuited. Word "normal" in relay pins means that mode when relay is not energized.

SERIES / PARALLEL CONNECTION

Reserve 2cm space on both sides for proper cooling.

Parallel operation: Passive load sharing. Do not chain the outputs, rated current 12A / pin. Recommended cable size: 2.5mm², length > 0.5m for optimum load sharing. External series diodes are needed for parallel connection of 60W models (FET type built in "series diode circuit" does not work properly in parallel connection). 125/250W models can be connected in parallel with or without series diodes. Redundant n+1 system can be made only with series diodes.

Series operation: Up to 500V total voltage.

TEMPERATURE COMPENSATION

Temperature compensated charging provides the optimum float charge voltage when batteries are being used. To utilize this feature it is necessary to install a NTC sensor across the temperature compensation pins on the output connector. It is also necessary to set the jumper on the front panel to ON position. The output voltage should be adjusted when the jumper is in the OFF position. This will simulate room temperature and ensure accuracy. The recommended sensor type is a 2.2k ohm NTC resistor, e.g. Epcos B57164-K222-K. The sensor should be installed local to the batteries. The sensor is galvanically connected to the + output. Temperature compensation sensor is included in rectifier models (x =7, 8 or 9) delivery

LED

A green LED indicates that the output of the module is healthy.

OUTPUT OVERCURRENT PROTECTION

Automatic, self-resetting electronic current limiting is included and the output is short circuit proof.

OUTPUT OVER VOLTAGE PROTECTION (OPTION)

Output of the unit will shut down if the output voltage rises above protection level. (16Volts/12V models, 31Volts/24V models and 58 Volts/48V models). Protection must be manually resetted by disconnecting the AC mains voltage.

OUTPUT VOLTAGE REMOTE SHUT DOWN AND BATTERY TEST OPTIONAL MODELS

Output of the unit will shut down, when a +4...15VDC signal is applied to the remote control input (RC) with reference to negative output.

In battery test models output voltage drops 15-25% when a +4...15VDC signal is applied to the RC pins as above.

The output voltage will return to the original level, when +4...15VDC signal is removed from RC pins.

INTERNAL OUTPUT SERIES DIODE OPTION (125/250W series diode, 60W FET circuit)

The internal diode is placed in series with the positive output. The benefits of having the diode fitted are:

- Improved redundancy if the modules are connected in parallel (not for 60W models, external series diode needed)
- Power OK signal and LED work independently regardless battery or parallel connections
- The parallel connected modules can be Hot Plug replaced without the system output power interruption (60W models need external series diode)
- The reverse current bleed is low if a battery is connected to the output of the rectifier

The disadvantages of having the diode fitted are lower efficiency, deration to the output voltage regulation and load sharing.

Note: The output series diode does not protect against reverse polarity connection of the battery.