

Measurement and Sensor Systems with conception



Precision Rotary Potentiometer



Precision Rotary Potentiometer

with resistance, current or voltage output

Today potentiometric angular position transmitters attain a still more status with regard to the analogue measuring technique as far as high-quality measurement tasks are concerned due to the favourable value for money.

They are mainly used for

- **Power braking control elements for railway vehicles as well as ship telegraphs**
- **Rudder and propeller systems for ships**
- **Control drives for systems in the field of energy management and chemical industry**
- **Lifting gears and slewing mechanisms of cranes and excavators**
- **Tail vanes for meteorological measurements**
- **As dancer potentiometers for textile and paper machinery**
- **As well as for measurements in the field of mechanical, apparatus and medical engineering**

Potentiometric transmitters have either a high-resolution element of conductive plastic or high-resolution gold or constantan wire with various resistance and angle values.

They are available in various sizes as single-turn or multiple-turn potentiometers or in a multiple design.

For adjustment of the measuring range almost all series can be provided with shorted sections, tappings and function windings.

Some models are available with incorporated signal converter providing current or voltage outputs in configuration of 2, 3 or 4 wires.

To ensure reliability in very dirty atmospheres, oil-filled potentiometers are available.

Moreover, to provide protection for all potentiometers from mechanical damage, dusty and damp industrial atmospheres a series of housings with a protection of the types IP 40 to IP 68 is available; partly to be equipped with gearing and limit switches.

Application ranges

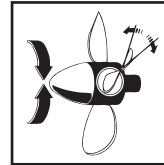
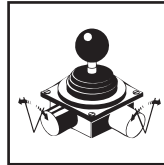

Versions and circuit variations

Series PW



Resistance elements as **ring winding** with wire winding on an anodised aluminium anchor ring can be provided with any circuit, angle and resistance values.

1. Wiper limited by stops
2. Wiper continuous rotation over 360° with reactive winding
3. Wiper continuous rotation over 360° without reactive winding (sawtooth shape)
4. Any arrangement of shorted sections
5. Any arrangement of tappings
6. 7. 8. Special windings with characteristic curve of the linear or sin/cos type
9. Two electrically isolated windings on a winding former, angle $\leq 175^\circ$

Series PW

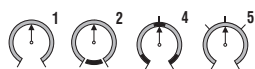

Resistance elements as **straight winding** with wire winding on a coated former of copper wire are used in potentiometers of the multiple-turn or linear type but also in single-turn potentiometers with active angles up to max. 350°.

1. Wiper limited by stops
2. Wiper continuous rotation over 360° only for purposes of putting into operation
4. Any arrangement of shorted sections
5. Any arrangement of tappings

Series PK



Resistance elements of **conductive plastic**, imprinted on glass-fiber reinforced supports. The max. active angle amounts to 355°. Smaller angles, tappings and shorted sections on request.

1. Wiper limited by stops
2. Wiper continuous rotation over 360°
4. Any arrangement of shorted sections
5. Any arrangement of tappings
7. Sin/cos characteristic curve
9. Two electrically isolated windings on a winding former, angle $\leq 175^\circ$

Electrical specifications

Version	wire-wound						
Design							
Model types	PW 609	PW 611	PW 613		PW 620		PW 1023
Resistance element	straight-shaped	straight-shaped	straight-shaped	ring	straight-shaped	ring	ring
Material of housing	aluminium, anodised						
Synchro size	9	11	13		20		23
Diameter of housing	22,2 mm	28 mm	36,5 mm		50,8 mm		60 mm
IP code of housing	IP 30	IP 30	IP 30		IP 30		IP 65
Diameter of shaft	3 / 6 mm	6 mm	6 mm		6 mm		6 / 10 mm
Shaft bearing	ball-/sintered bearing	ball-/sintered bearing	ball-/sintered bearing		ball-/sintered bearing		ball bearing
Material of shaft	stainless steel						
Adjustment speed max.	360 U/min.						
Torque	0,03 Ncm	0,04 Ncm	0,05 Ncm		0,05 Ncm		2,5 Ncm
Torque (oil-filling)	–	–	–	1 Ncm	–	1 Ncm	–
max. active angle ($\pm 0,5^\circ$)	340°	340°	345°	360°	350°	360°	360°
max. stop angle	340°	340°	345°		345°		345°
Value of resistance	up to 10 k Ω	up to 10 k Ω	up to 20 k Ω		up to 20 k Ω		up to 20 k Ω
Resistance tolerance	5 %	5 %	5 %	2 %	5 %	2 %	2 %
Linearity tolerance	$\pm 0,5$ %	$\pm 0,5$ %	$\pm 0,2$ %		$\pm 0,2$ %		$\pm 0,2$ %
Resolution (windings)*	1033	1369	1851	2100	3434	max. 2321	max. 2321
Capacity	0,5 W	0,5 W	1 W	2,5 W	1 W	2,5 W	2,5W
Multiple version	threefold	threefold	sixfold		sixfold		twofold
Functional winding	–	–	–	✓	–	✓	✓
Oilfilling	–	–	–	✓	–	✓	–
Switches	–	–	–	✓	–	✓	–
Connection	soldered connection/wire	soldered connection/wire	soldered connection / wire		soldered connection / wire		plug / cable
Weight **	15g	20 g	40 g		70 g		380 g
Article number	1114Z70	1122Z01	1567Z01	1560Z10	1577Z01	1570Z02	5720Z52

* depend on resistance value and active angle

** single version

General Data	
Temperature range	-30° C up to +80° C
Test voltage	550 V, 50 Hz, 1 min.
Vibration resistance	5 - 200 Hz, 10 g
Shock resistance	50 g, 6 ms
Life time	high life time due to a patent-registered spiral wiper 10 - 100 millions cycles
Fastening	depend on version: Central fixing, clamp fixing, threaded holes

Electrical specifications

Version	wire-wound					
Design						
Model types	PW 0045	PW 45	PW 45 W 3/10		PW 55	PW 70
Resistance element	straight-shaped	ring	straight-shaped		straight-shaped	ring
Material of housing	thermoplast	thermoplast	brass / thermoplast		thermoplast	thermoset
Synchro size	FSG design					
Diameter of housing	45 mm	45 mm	45 mm	□ 55 mm	70 mm	
IP code of housing	IP 30					
Diameter of shaft	6 mm	6 mm	6 mm	Hollow shaft 6 x 6 mm		
Shaft bearing	sintered bearing	sintered bearing	sintered bearing	plastic bush bearing	sintered bearing	
Material of shaft	stainless steel					
Adjustment speed	60 U/min.	360 U/min.	360 U/min.		60 U/min.	360 U/min.
Torque	0,5 Ncm / 5 Ncm	0,3 Ncm / 3 Ncm	0,5 Ncm		0,2 Ncm	0,5 Ncm
Torque (oil-filling)	–	1 Ncm	–		–	1 Ncm
max. active angle ($\pm 0,5^\circ$)	280° / 345°	360°	1080°	3600°	350°	360°
max. stop angle	280° / 345°	345°	1080°	3600°	345°	350°
Value of resistance	up to 25 k Ω	up to 20 k Ω	up to 25 k Ω		up to 20 k Ω	up to 50 k Ω
Resistance tolerance	5 %	2 %	5 %		5 %	2 %
Linearity tolerance	$\pm 0,5$ %	$\pm 0,3$ %	$\pm 0,1$ %		$\pm 0,5$ %	$\pm 0,15$ %
Resolution (windings)*	max. 2312	max. 2321	max. 5783	max. 21049	1620	max. 3621
Capacity**	1,5 W	2,5 W	2 W		1,5 W	6 W
Multiple version	–	twofold	twofold		stackable	sixfold
Functional winding	–	✓	–		–	✓
Oilfilling	–	✓	–		–	✓
Switches	–	–	–		–	✓
Connection	soldered connection	soldered-/screwed connection	soldered connection		plug Faston	soldered-/screwed connection
Weight	70 g	70 g	100 g	150 g	50 g	140 g
Article number	1511Z07	1500Z05	1302Z10	1300Z10	1573S10	1700Z04

* depend on resistance value and active angle

** single version

Electrical specifications

Version	conductive plastic					
Design						
Model types	PK 609	PK 611	PK 613	PK 613-G16	PK 620	PK 1023
Resistance element	conductive plastic					
Material of housing	aluminium, anodised					
Synchro size	9	11	13		20	23
Diameter of housing	22,2 mm	28 mm	36,5 mm		50,8 mm	60 mm
IP code of housing	IP 30	IP 30	IP 30		IP 30	IP 65
Diameter of shaft	3 / 6 mm	6 mm	6 mm		6 mm	6 / 10 mm
Shaft bearing	ball-/sintered bearing	ball-/sintered bearing	ball-/sintered bearing		ball-/sintered bearing	ball bearing
Material of shaft	stainless steel					
Adjustment speed max.	1000 U/min.					
Torque	0,03 Ncm	0,04 Ncm	0,05 Ncm		0,05 Ncm	2,5 Ncm
Torque (oil-filling)	–	–	–		1 Ncm	–
max. active angle ($\pm 0,5^\circ$)	345°	345°	350°	5632°	355°	355°
max. stop angle	340°	340°	345°	5632°	345°	345°
Value of resistance	1 k Ω up to 10 k Ω					
Resistance tolerance	$\pm 20\%$	$\pm 20\%$	$\pm 10\%$		$\pm 10\%$	$\pm 10\%$
Linearity tolerance	$\pm 2\% / \pm 0,5\%^{**}$	$\pm 2\% / \pm 0,2\%^{**}$	$\pm 1,5\% / \pm 0,15\%^{**}$	$\pm 0,5\%$	$\pm 1,5\% / \pm 0,1\%^{**}$	$\pm 1,5\% / \pm 0,1\%^{**}$
Resolution	almost infinite					
Capacity	0,5 W	0,5 W	1 W		1 W	1 W
Multiple version	threefold	threefold	sixfold	onefold	sixfold	twofold
Functional curve	✓	✓	✓		✓	✓
Oilfilling	–	–	–		✓	–
Switches	–	–	–		✓	–
Connection	soldered connection/wire	soldered connection/wire	soldered connection / wire		soldered connection/wire	plug / cable
Weight*	15 g	20 g	40 g	120 g	70 g	380 g
Article number	1105Z02 / 1125Z01	1120Z02	1565Z02	2720Z50	1575Z02	5710Z52

* single version

** linearised version

General data	
Temperature range	-30° C up to +80° C
Test voltage	550 V, 50 Hz, 1 min.
Vibration resistance	5 - 200 Hz, 10 g
Shock resistance	50 g, 6 ms
Life time	high life time due to a patent-registered spiral wiper 10 - 100 million cycles
Fastening	depend on version: Central fixing, clamp fixing, threaded holes

Potentiometric circuit and its characteristic curves

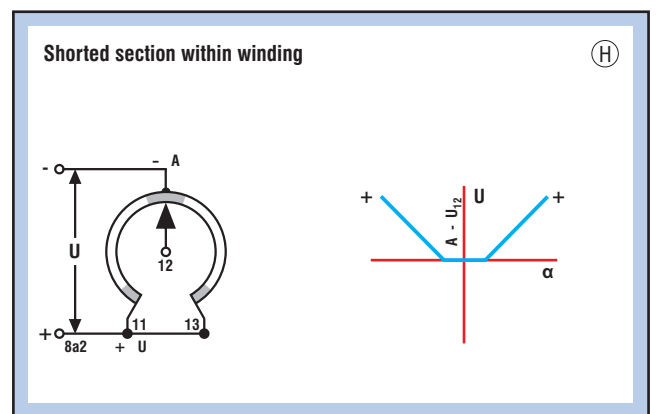
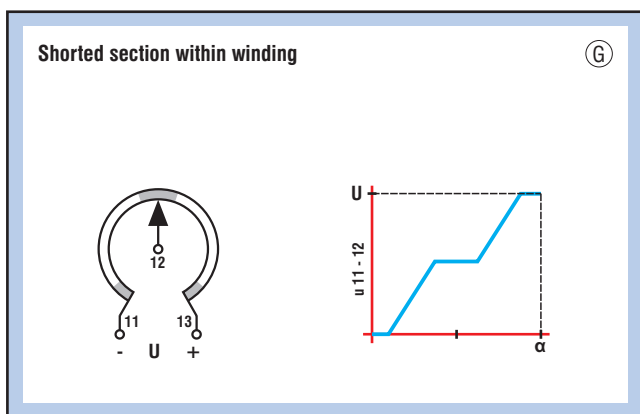
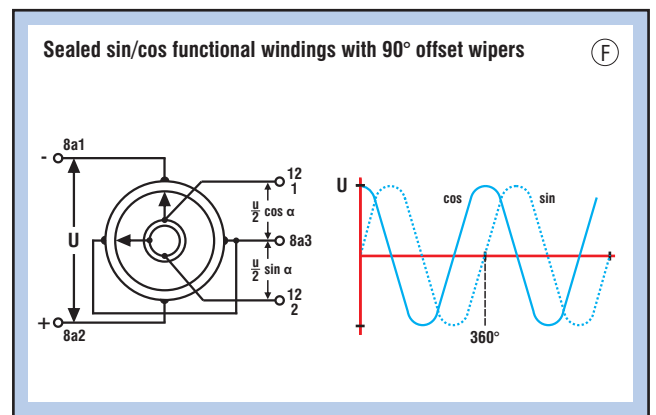
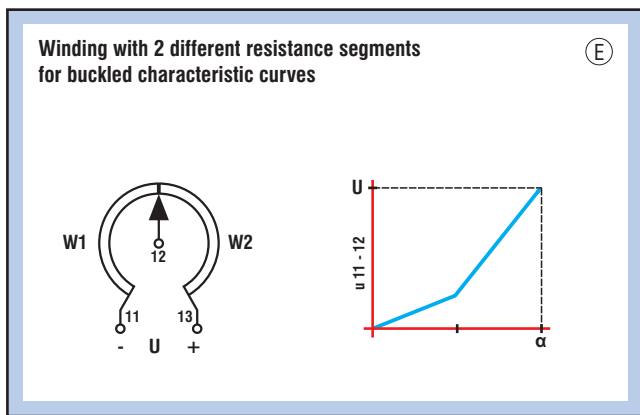
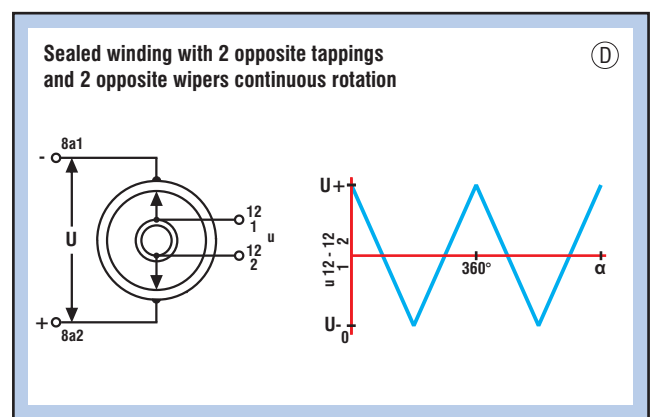
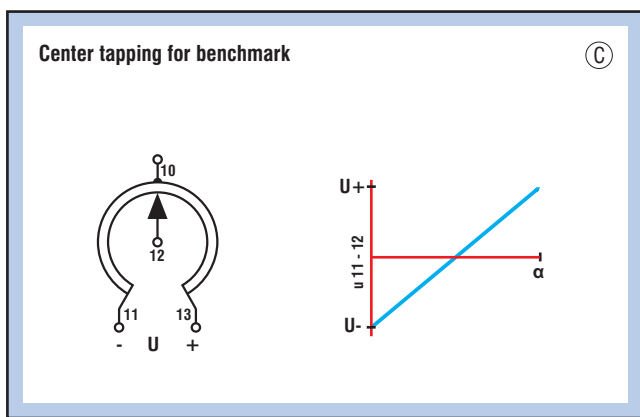
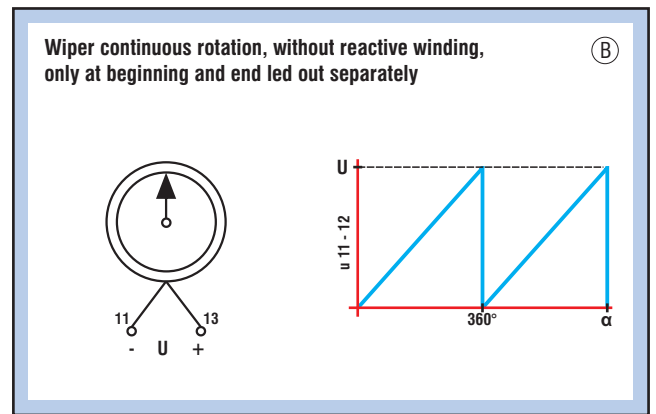
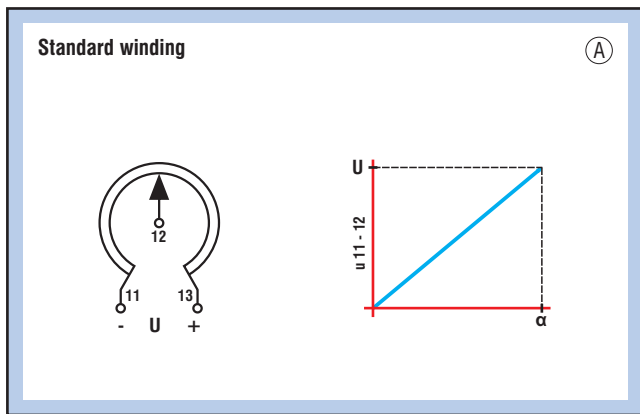

Designs

PW / PK 609

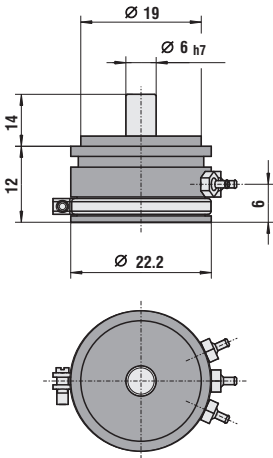

PW / PK 611

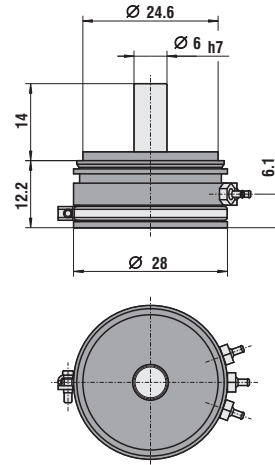

PW / PK 613

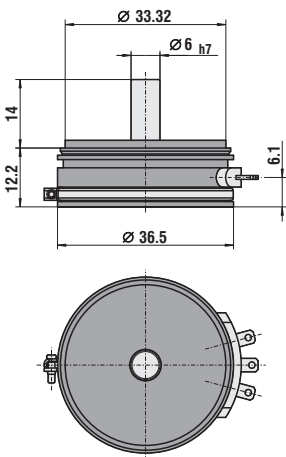

PW / PK 620

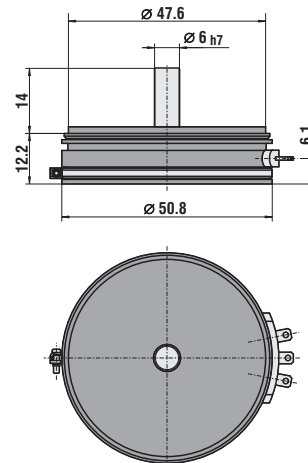

PW / PK 1023

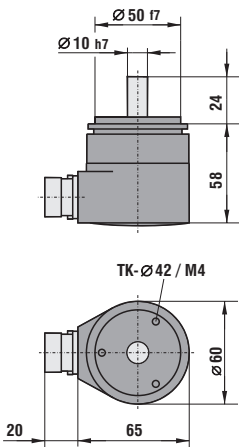

PW 0045

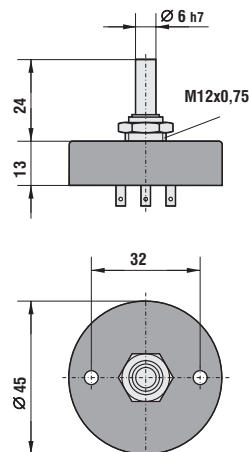

PW 45

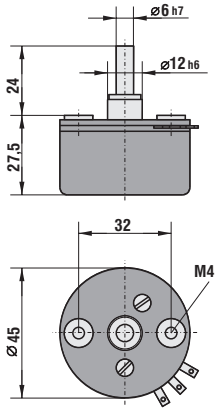

PW 45W 3/10

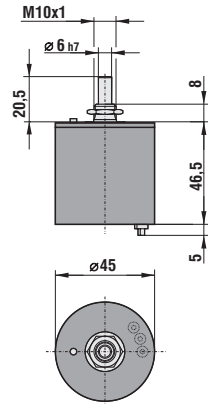

PW 55

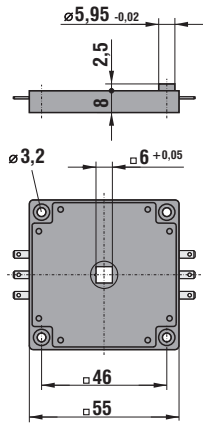

PW 70

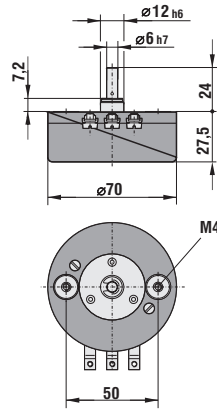

PW 70M

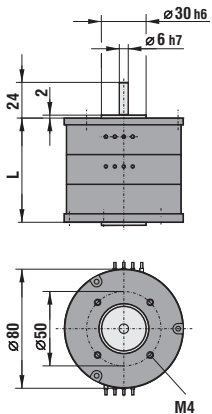

L	50	70	90	110	130	150
	MI	MII	MIII	MIV	MV	MVI

Angular Position Transducers

Type series PW / PK ... -MU



4-wire system with galvanic isolation

3- or 4-wire system

2-wire system

Angular position transducers, equipped with resistance elements of wire or plastic resistance elements with integrated R/I or R/V converter for current or voltage output, optional with a configuration of 2, 3 or 4 wires.

Also available with galvanic isolation between supply and output signal as far as version with 4 wires is concerned.

All types of transducers are provided with rear trimmer to match output signal within wide ranges to the respective angular deflection.

Electrical specifications

Type series	PW / PK 613-MU	PW / PK 620-MU	PW / PK 1023-MU
Voltage output	–	0 - 10 and 2 - 10 V respectively	
Load resistance	≥ 2 kΩ		
Current voltage	0 - 20 and 4 - 20 mA respectively		
Load resistance	≤ 600 Ω		
Supply voltage	18 - 33 V DC		
Current consumption	approx. 80 mA		
4-wire system galvanically isolated	–	✓	✓
2-, 3- or 4-wire system	✓	✓	✓
TC	max. 1 % / 10 K; typically: 0,5 % / 10 K		
Linearity	± 0,2 %	± 0,1 %	± 0,1 %

Zero point and rise to be adjusted via trimmer

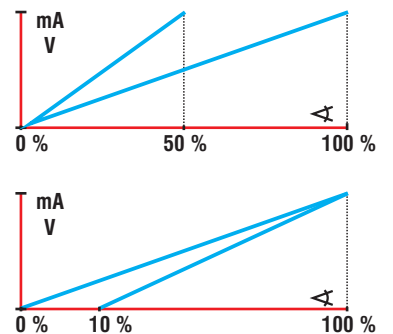

PW / PK 613-MU / 620-MU

PW / PK 1023-MU

Specifications of protective housings

Series A

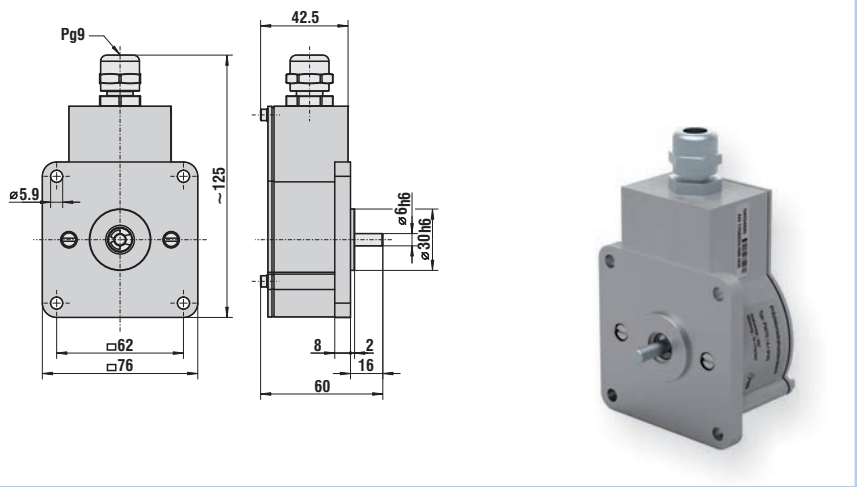

Mechanical data	
Housing	alu, grey coated
IP code	IP 40 or IP 65
Shaft	stainless steel
Bearing friction	0,8 Ncm
Weight	ca. 0,4 ... 1 kg
Article number	1708Z03

Housing suitable for accommodation of any potentiometer of type series PW70 in single design.

Series G 90

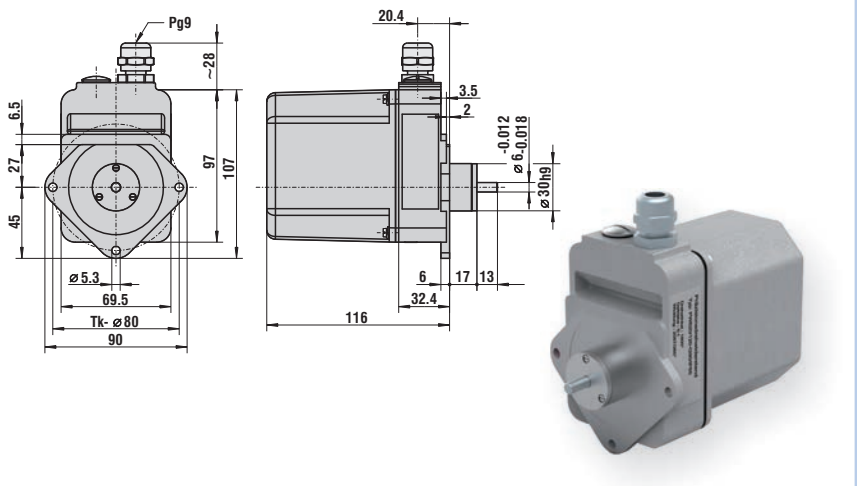

Mechanical data	
Housing	alu, grey coated
IP Code	IP 40 or IP 65
Shaft	stainless steel
Bearing	2 ball bearings
Bearing friction	IP 40 = 0,1 Ncm IP 65 = 1,5 Ncm
Gearing	1:1 up to 1:10 * 1:1 up to 25:1 * 26:1 up to 125:1 **
Weight	approx. 1 kg
Article number	3601Z02

Housing suitable for accommodation of any transmitter size up to 54 mm outside diameter.

* free from backlash, ** low backlash

Series GS 120

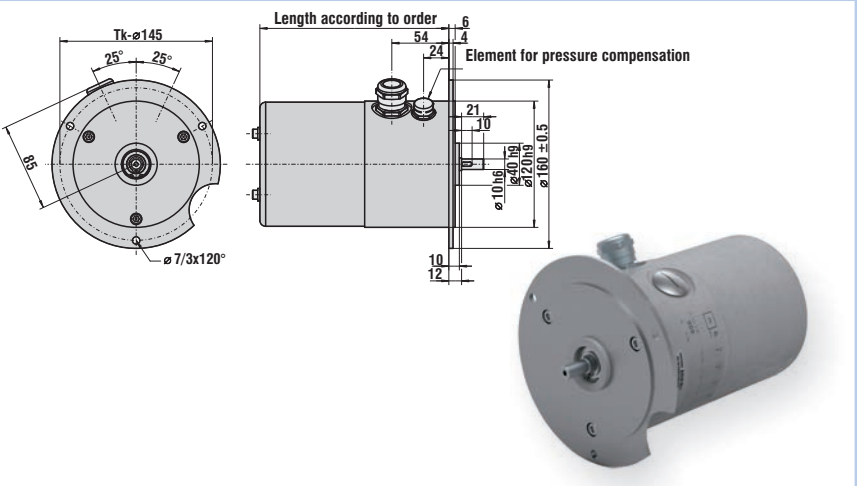

Mechanical data	
Housing	alu, grey coated
IP Code	IP 65
Shaft	stainless steel
Bearing	2 ball bearings
Bearing friction	1,5 Ncm
Gearing	1:1 up to 216:1 * 1:1 up to 1296:1 ** 1:1 up to 1:10 ***
Weight	ca. 2,5 kg
Article number	1892Z

Housing suitable for accommodation of any transmitter size up to 70 mm outside diameter.

* free from backlash, ** low backlash

*** free from backlash or low backlash



Headquarter in Berlin

Berlin

Fernsteuergeräte

Kurt Oelsch GmbH

Jahnstraße 68 + 70

D-12347 Berlin



Factory in Kablow

Kablow

FSG Fernsteuergeräte

Meß- und Regeltechnik GmbH

OT Kablow

Mühlenweg 2 -3

D-15712 Königs Wusterhausen



Factory in Heppenheim

Heppenheim

Fernsteuergeräte

Kurt Oelsch GmbH & Co.KG

Weierhausstraße 10

D-64646 Heppenheim



info@fernsteuergeraete.de
www.fernsteuergeraete.de