

# Compression Tools – Selection



## CP-0214 – C Yoke

- Single and Tandem cylinder options
- Riveting Capacity –
  - ø 1/8" 3.2mm (single cylinder)
  - ø 3/16" 4.8mm (tandem cylinder)
- Lock-off throttle – reduces the risk of accidental operation



## CP-0341 – C Yoke

- Patented 'Pneudraulic™' air-hydraulic riveter
- Riveting Capacity –
  - ø 9/32" 7.14mm
- Lock-off throttle – reduces the risk of accidental operation
- Versatile – can accommodate various rivet lengths and joint thickness by adjustment of air pressure (reducing setting times and eliminates the need to use set length spacer shims with the rivet sets)



## CP-0351 – C Yoke

- Single and Tandem cylinder options
- Riveting Capacity –
  - ø 3/16" 4.8mm (single cylinder)
  - ø 1/4" 6.4mm (tandem cylinder)
- Actuation throttle guard – reduces the risk of accidental operation
- Short stroke adjustment – aids positioning of the tool (limits the return travel of the moving set of the tool on the rivet to reduce the starting clearance between rivet and rivet sets)



## CP-0214 – Alligator Jaw

- Single and Tandem cylinder options
- Riveting Capacity –
  - ø 1/8" 3.2mm (single cylinder)
  - ø 3/16" 4.8mm (tandem cylinder)
- Lock-off throttle – reduces the risk of accidental operation



## CP-0351 – Alligator Jaw

- Single and Tandem cylinder options
- Riveting Capacity –
  - ø 9/32" 4.0mm (single cylinder)
  - ø 1/4" 6.4mm (tandem cylinder)
- Actuation throttle guard – reduces the risk of accidental operation
- Short stroke adjustment – aids positioning of the tool (limits the return travel of the moving set of the tool on the rivet to reduce the starting clearance between rivet and rivet sets)

## Selection Criteria

### • Type of Rivet

- Rivet material
- Rivet body diameter
- Rivet length before and after compression
- Force required to compress rivet (if known)

### • What material is the rivet made from?

### • What size is the rivet?

### • What is the form of the rivet head?

### • Components to assemble

- Access to rivet on assembly

### • Open access (up to 2 1/8"/54mm reach)

– 'C' Yoke tool

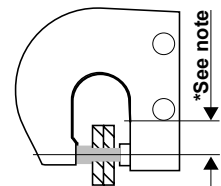

### • Restricted access (up to 9 1/8"/232mm reach)

– 'Alligator' Jaw tool

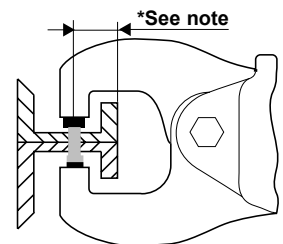

• **Note:** the amount of reach required is determined by the distance from the rivet centreline to the accessible edge of the workpiece

**Lou Zampini & Associates**

2 Douglas Pike, Rt. 7

Smithfield, RI 02917

1 800 353 4676

FAX 1 401 679 0165

# Compression Tools – Selection

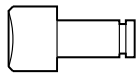

## Compression Rivet Sets

(Complete with retaining rings)

Minimum Order: 6 of any part number.

**Note:** The illustration above shows one rivet set. Two rivet sets are required to be used per tool. Part numbers are for one rivet set only.

## SELECTING RIVET SETS TO FIT CP-0214, CP-0341 & CP-0351 RIVETERS

To develop maximum power, the riveter must drive (set) the rivet at the end of the riveter's stroke (with the exception of the CP-0341 which develops max power throughout its full stroke).

For maximum power the combined length of the two rivet sets must be of the correct length.

Determine the correct lengths as follows:

### 1) When two cupped rivet sets are used:

The length of the body dimensions of the rivet sets ( $A_1$ ,  $A_2$ ) should equal the closed height dimension of the yoke  $H$  minus the total thickness of material being riveted together.

### 2) When one cupped set and one flush set are used:

The length of the body dimensions of the two rivet sets ( $A_1$ ,  $A_2$ ) should equal the closed height dimension of the yoke ( $H$ ) minus the total thickness of the material being riveted ( $M$ ) and the height of the finished rivet head ( $Z$ ) compressed by the flush set ( $A$ ).

### 3) When two flush sets are used:

The length of the body dimensions of the two rivet sets ( $A_1$ ,  $A_2$ ) should equal the closed height dimension of the yoke ( $H$ ) minus the overall length of the rivet ( $L$ ) after it is compressed.

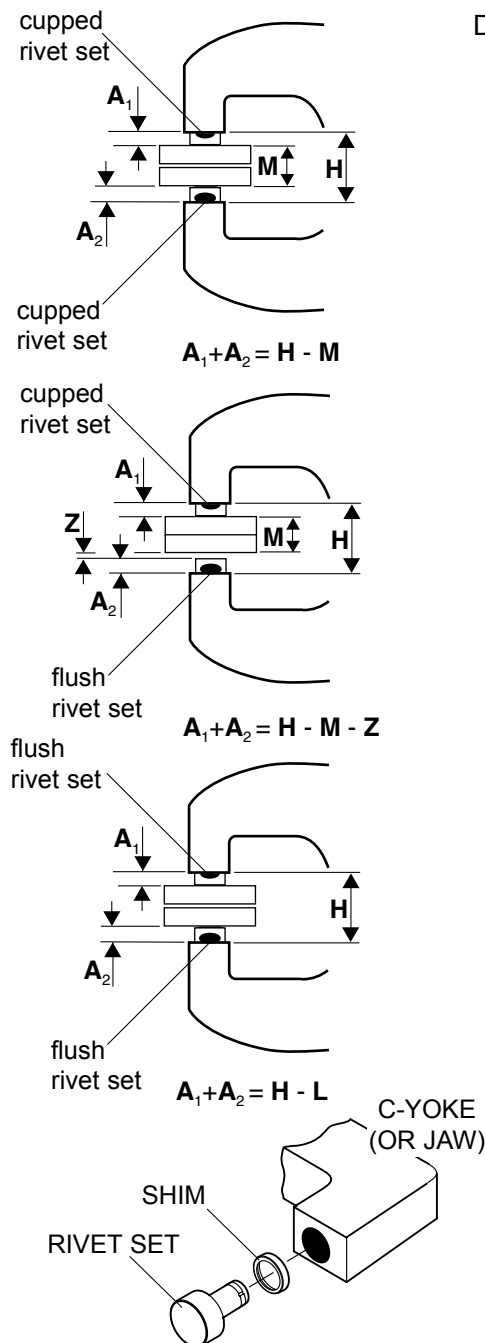

If necessary, select rivet sets a little short and shim to the correct length using spacer shims.

# Compression Tools – Rivet Sets

RIVET DIAMETER		'A' BODY LENGTH		AN-435 BUTTON	AN-430 ROUND	AN-455 BRAZIER	AN-456 MODIFIED BRAZIER	AN-470 UNIVERSAL	AN-442 FLAT
in.	mm	in.	mm	part no.	part no.	part no.	part no.	part no.	part no.

## CR-1 SHANK RIVET SETS FOR CP-0214 & CP-0351 – CUPPED SETS

(C-Yoke tools – CP-0214 CELEL, FALEL, CUDEL, FUDEL + all Alligator Yoke tools)

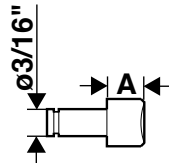

3/32"	2.4	1/4"	6.4	P091601	P089370	P089390	P089410	P089430	P091621
3/32"	2.4	3/8"	9.5	P091602	P089371	P089391	P089411	P089431	P091622
3/32"	2.4	1/2"	12.7	–	–	–	P089412	P089432	P091623
1/8"	3.2	1/4"	6.4	P091606	P089375	P089395	P053826	P089435	P091626
1/8"	3.2	3/8"	9.5	P091607	P089376	–	P053827	P089436	P091627
1/8"	3.2	1/2"	12.7	P091608	P089377	P089397	–	P089437	P091628
5/32"	4.0	1/4"	6.4	P091611	P089380	P089400	P053831	P089440	P091631
5/32"	4.0	3/8"	9.5	P091612	P089381	P089401	P053832	P089441	P091632
5/32"	4.0	1/2"	12.7	P091613	P089382	P089402	P053833	P089442	P091633
3/16"	4.8	1/4"	6.4	P091616	P089385	P089405	P053836	P089445	P091636
3/16"	4.8	3/8"	9.5	P091617	P089386	P089406	P053837	P089446	P091637
3/16"	4.8	1/2"	12.7	P091618	P089387	P089407	P053838	P089447	P091638

## CR-2 SHANK RIVET SETS FOR CP-0214 & CP-0341 – CUPPED SETS

(C-Yoke tools – CP-0214 SETEL, KETEL + CP-0341 CUDEL)

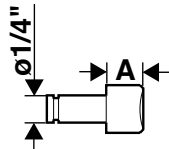

1/8"	3.2	1/4"	6.4	–	–	–	–	P089510	P091661
1/8"	3.2	3/8"	9.5	P091642	–	–	–	P089511	–
1/8"	3.2	1/2"	12.7	–	–	–	–	P089512	P091663
5/32"	4.0	1/4"	6.4	–	P089455	–	–	P089515	–
5/32"	4.0	3/8"	9.5	–	–	–	–	P089516	P091667
5/32"	4.0	1/2"	12.7	P091648	–	–	–	P089517	P091668
3/16"	4.8	1/4"	6.4	–	P089460	P089480	–	P089520	P091671
3/16"	4.8	3/8"	9.5	–	P089461	P089481	–	P089521	P091672
3/16"	4.8	1/2"	12.7	P091653	–	P089482	–	P089522	P091673
1/4"	6.4	1/4"	6.4	–	P089465	P089485	–	P089525	P091676
1/4"	6.4	3/8"	9.5	–	P089466	P089486	–	P089526	–
1/4"	6.4	1/2"	12.7	–	P089467	–	–	P089527	P091678

SHANK SIZE	'A' BODY LENGTH					
	1/8"	1/4"	3/8"	1/2"	5/8"	3/4"

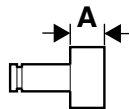

## FLUSH SETS for any rivet size

CR-1 (ø 3/16")	P089495	P089496	P089497	P089498	P089499	P089500
CR-2 (ø 1/4")	–	P089501	P089502	P089503	P089504	P089505

TYPE OF RIVET SET SHANK	'A' LENGTH		BODY DIAMETER		PART NUMBER
	in.	mm	in.	mm	

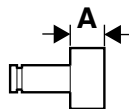

## SOFT SET BLANKS

CR-1 (ø 3/16")	3/4"	19.1	5/8"	15.9	P093672
CR-2 (ø 1/4")	3/4"	19.1	3/4"	19.1	P093673

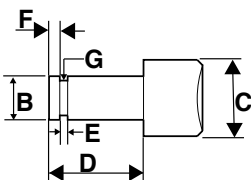

\* 'C' dimension is for flush set only. 'C' varies on cupped sets according to rivet size and type of head.

TYPE OF RIVET SET SHANK	B		C*		D		E		F		G	
	in.	mm	in.	mm	in.	mm	in.	mm	in.	mm	in.	mm

## SHANK DIMENSIONS FOR RIVET SETS

For CP-0214, CP-0351 and CP-0341 Compression Riveters

CR-1 (ø 3/16")	0.187-0.186	4.75-4.72	1/2	12.7	1/2	12.7	0.136-0.133	3.45-3.38	1/16	1.6	0.127-0.123	3.23-3.12
CR-2 (ø 1/4")	0.249-0.248	6.42-6.40	5/8	15.9	5/8	15.9	0.136-0.133	3.45-3.38	3/32	2.4	0.189-0.185	4.80-4.70

# Compression Tools – Riveting



A



B



C



D



E

For detailed dimensions please refer to "Technical Data" – page 42

PICTURE REF	MODEL	PART NUMBER	CAPACITY				STANDARD YOKE DIMENSIONS				MAX FORCE		MOVING PLUNGER			
			ALUM.		STEEL		REACH		CLOSED HEIGHT		(90 psi/6.2 bar)		MAX. TRAVEL		FINAL PART OF STROKE AT MAX. FORCE	
			in.	mm	in.	mm	in.	mm	in.	mm	lb	kN	in.	mm	in.	mm
A	CP0214CELEL	T012344	1/8	3.2	3/32	2.4	1 1/2	38.1	1 1/16	17.5	3,000	13.35	9/16	14.3	0.050	1.3
A	CP0214SETEL	T023474	1/8	3.2	3/32	2.4	1 1/2	38.1	1 1/16	17.5	3,000	13.35	9/16	14.3	0.050	1.3
A	CP0214FALEL	T013152	3/16	4.8	5/32	4.0	1 1/2	38.1	1 1/16	17.5	6,000	26.70	9/16	14.3	0.063	1.6
A	CP0214KETEL	T023475	3/16	4.8	5/32	4.0	1 1/2	38.1	1 1/16	17.5	6,000	26.70	9/16	14.3	0.063	1.6
B	CP0351CUDEL	T008955	3/16	4.8	5/32	4.0	2 1/8	54.0	25/32	19.8	6,000	26.70	9/16	14.3	0.125	3.2
B	CP0351FUDEL	T012608	1/4	6.4	7/32	5.6	2 1/8	54.0	25/32	19.8	12,000	53.40	9/16	14.3	0.125	3.2
D	CP0341CUDEL	T022512	9/32	7.1	1/4	6.4	2 1/8	54.0	1	25.4	13,500	60.10	1 1/4	31.8	Full stroke	
C	CP0214ANFEL	T018671	3/32	2.4	3/32	2.4	2 1/4	57.1	7/8	22.2	2,200	9.79	7/16	11.1	0.094	2.4
C	CP0214ANGEL	T018672	3/32	2.4	1/16	1.6	3	76.2	7/8	22.2	1,800	8.01	1 1/4	31.8	0.056	1.4
C	CP0214ANBEL	T012343	1/8	3.2	3/32	2.4	1 1/2	38.1	7/8	22.2	3,000	13.35	5/8	15.9	0.050	1.3
C	CP0214ENGEL	T018164	1/8	3.2	3/32	2.4	3	76.2	7/8	22.2	3,400	15.13	1 1/4	31.8	0.104	2.6
E	CP0351ASKEL	T007773	1/8	3.2	3/32	2.4	5	127.0	7/8	22.2	3,400	15.13	1 3/8	34.0	0.188	4.8
E	CP0351ASVEL	T009582	1/8	3.2	3/32	2.4	9 1/8	232.0	3/4	19.1	3,000	13.35	1 11/16	42.9	0.063	1.6
C	CP0214ENFEL	T018163	5/32	4.0	1/8	3.2	2 1/4	57.1	7/8	22.2	4,300	19.14	7/8	22.2	0.094	2.4
E	CP0351ASGEL	T007783	5/32	4.0	1/8	3.2	2 7/8	73.0	7/8	22.2	5,200	23.14	5/8	15.9	0.125	3.2
C	CP0214ENBEL	T018678	3/16	4.8	5/32	4.0	1 1/2	38.1	7/8	22.2	6,000	26.70	5/8	15.9	0.063	1.6
E	CP0351ESKEL	T012603	3/16	4.8	5/32	4.0	5	127.0	7/8	22.2	6,800	30.26	1 3/8	34.0	0.188	4.8
E	CP0351ESREL	T012604	3/16	4.8	5/32	4.0	7	178.0	1 1/2	38.1	6,000	26.70	1 11/16	42.9	0.188	4.8
E	CP0351ESVEL	T012605	3/16	4.8	5/32	4.0	9 1/8	232.0	3/4	19.1	6,000	26.70	1 11/16	42.9	0.063	1.6
E	CP0351ESGEL	T012602	1/4	6.4	3/16	4.8	2 7/8	73.0	7/8	22.2	10,400	46.28	5/8	15.9	0.125	3.2

# Compression Tools – Sheet Metal Punch

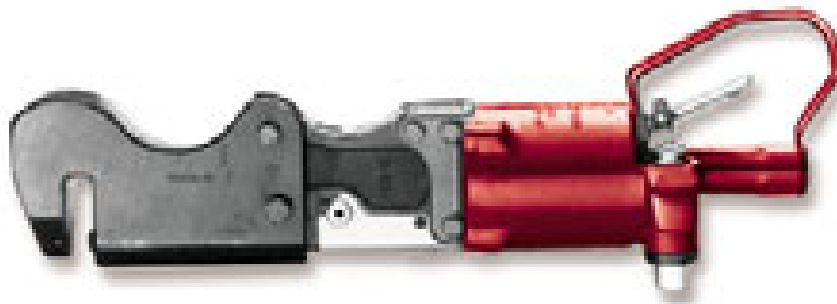

## CP-0351-PU

- Punching Capacity:  
 $\varnothing$   $\frac{3}{16}$ " (4.8mm) in aluminium  
 through  $\frac{3}{16}$ " (4.8mm) material thickness
- Actuation throttle guard:  
 reduces the risk of accidental operation
- Use for a wide range of punching operations where it is preferable to take the tool to the job.  
 e.g. large structures such as truck trailers

### Capacity:

Maximum hole is  $\varnothing$   $\frac{1}{2}$ " (13mm) relative to material and thickness.  
 Within maximum force of 5,400 lbs – 24.0 kN, material thickness should not exceed hole diameter.

To determine force required use formula: **F = 3.14 x D x T x S**

where "F" is force (lbs); "D" is hole diameter (in.); "T" is thickness of material (in.); "S" is tensile strength of material (psi) or "F" is force (N); "D" is hole diameter (mm); "T" is thickness of material (mm); "S" is tensile strength of material (N/mm<sup>2</sup>)

### Standard Equipment supplied with tool:

(1) Punch – Part No. P041307, (1) Die – Part No. P043009  
 and (1) stripping collar – Part No. P043109  
 for punching hole for  $\varnothing$   $\frac{3}{16}$ " (4.8mm) rivet in  $\frac{3}{16}$ " (4.8mm)  
 thick aluminium.

MODEL	PART NUMBER	MAX. MATERIAL THICKNESS ALUM.		HOLE DIAMETER		MAX. DISTANCE EDGE OF SHEET TO HOLE CENTRELINE		MAX. PUNCHING FORCE (90 psi/6.2 bar)		WORK CLEARANCE PUNCH RETRACTED	
		in.	mm	in.	mm	in.	mm	lb	kN	in.	mm
CP-0351PU	T013417	$\frac{3}{16}$	4.8	$\frac{3}{16}$	4.8	$\frac{17}{8}$	47.6	5400	24.0	$\frac{1}{2}$	12.7

# Compression Tools – Edge Former



## CP-0351-CABH-DY

- Forming Capacity (max material thickness) –  $\varnothing$  1/4" (6.4mm)
- Rotary Suspension Bail fitted – eases handling and orientation of tool
- Use for a wide range of flattening of spot welded flanges and removing bends
- Custom yokes and dies can be used for crimping and staking operations
- Automatic cycling frequency is adjustable from 1 cycle per throttle actuation to, up to 200 cycles per minute while the throttle actuation is maintained

### Standard Equipment supplied with tool:

(1) Yoke – Part No. P059557, (1) Die – Part No. P059556 and (1) Ball Bearing Suspension Bail – Part No. P010245

MODEL	PART NUMBER	MAX. MATERIAL THICKNESS ALUM.		MAX. CYCLES PER MINUTE	REACH		MAX. COMPRESSIVE FORCE (90 psi/6.2 bar)	
		in.	mm		in.	mm	lb	kN
CP-0351-CABH-DY	T020475	1/4	6.4	200	9/16	14.4	6000	26.7

# Compression Tools – Technical Data

## Jaw & Yoke Terminology: (rivet sets are not in place in this illustration)

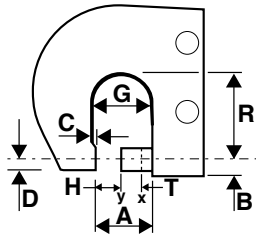

- A Throat gap
- B Upper offset
- C Anvil work clearance
- D Lower offset
- G Total yoke gap
- H Closed height
- R Reach
- T Travel

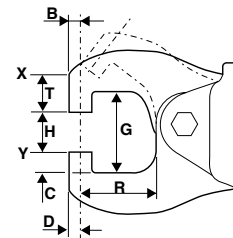

- x Extreme open position
- y Extreme closed position

C Yoke Model	A		C		D		G		H		R	
	in.	mm	in.	mm	in.	mm	in.	mm	in.	mm	in.	mm
CP0214CELEL	1 1/4	32	-	-	3/16	5	1 1/4	32	11 1/16	17.5	1 1/2	38
CP0214FALEL	1 1/4	32	-	-	3/16	5	1 1/4	32	11 1/16	17.5	1 1/2	38
CP0351CUDEL	1 17/32	39	-	-	7/32	5.5	1 3/32	29	25 3/32	20	2 1/8	54
CP0351FUDEL	1 17/32	39	-	-	7/32	5.5	1 3/32	29	25 3/32	20	2 1/8	54
CP0341CUDEL	2 1/4	57	1/8	3	11 1/32	9	2 3/4	70	1	25	2 1/8	54

Alligator Jaw Model	A		C		D		G		H		R	
	in.	mm	in.	mm	in.	mm	in.	mm	in.	mm	in.	mm
CP0214ANGEL	2 1/8	54	-	-	7/32	5.5	2 1/8	54	7/8	22	3	76
CP0214ENGEL	2 1/8	54	-	-	7/32	5.5	2 1/8	54	7/8	22	3	76
CP0214ANFEL	1 7/8	48	-	-	7/32	5.5	2 1/8	54	7/8	22	2 1/4	57
CP0214ENFEL	1 7/8	48	-	-	7/32	5.5	2 1/8	54	7/8	22	2 1/4	57
CP0214ANBEL	1 1/2	38	-	-	7/32	5.5	1 5/8	41	7/8	22	1 1/2	38
CP0214ENBEL	1 1/2	38	-	-	7/32	5.5	1 5/8	41	7/8	22	1 1/2	38
CP0214SETEL	-	-	-	-	-	-	-	-	-	-	-	-
CP0214KETEL	-	-	-	-	-	-	-	-	-	-	-	-
CP0351ASVEL	2 7/16	62	-	-	7/32	5.5	2 3/16	56	3/4	19	9 1/8	232
CP0351ESVEL	2 7/16	62	-	-	7/32	5.5	2 3/16	56	3/4	19	9 1/8	232
CP0351ESREL	3 3/16	81	-	-	7/32	5.5	2	51	1 1/2	38	7	178
CP0351ASKEL	2 1/4	57	-	-	7/32	5.5	1 5/8	41	7/8	22	5	127
CP0351ESKEL	2 1/4	57	-	-	7/32	5.5	1 5/8	41	7/8	22	5	127
CP0351ASGEL	1 1/2	38	-	-	7/32	5.5	1 5/8	41	7/8	22	2 1/8	73
CP0351ESGEL	1 1/2	38	-	-	7/32	5.5	1 5/8	41	7/8	22	2 1/8	73

Air inlet: 1/4" NPTF

MODEL	CYLINDER TYPE	RIVET SET TYPE	LENGTH		WEIGHT		SOUND LEVEL	SOUND POWER
			in.	mm	lb	kg		
CP0214ANBEL	Single	CR-1 (Ø 3/16")	9 3/16	233	3 3/4	1.7	90	101
CP0214ANFEL	Single	CR-1 (Ø 3/16")	10	254	4 1/4	1.9	90	101
CP0214ANGEL	Single	CR-1 (Ø 3/16")	10 3/4	273	4 1/2	2.0	90	101
CP0214CELEL	Single	CR-1 (Ø 3/16")	10 5/16	262	4 1/2	2.0	90	101
CP0214ENBEL	Tandem	CR-1 (Ø 3/16")	11 5/16	303	4 3/4	2.2	90	101
CP0214ENFEL	Tandem	CR-1 (Ø 3/16")	12 3/4	324	5 1/4	2.4	90	101
CP0214ENGEL	Tandem	CR-1 (Ø 3/16")	13 1/2	343	5 1/2	2.5	90	101
CP0214FALEL	Tandem	CR-1 (Ø 3/16")	14	356	5 1/2	2.5	90	101
CP0214KETEL	Tandem	CR-2 (Ø 1/4")	14	356	5 1/2	2.5	90	101
CP0214SETEL	Single	CR-2 (Ø 1/4")	10 5/16	262	4 1/2	2.0	90	101
CP0341CUDEL	Pneumatic®	CR-1 (Ø 3/16")	19 7/8	505	13 1/2	6.1	85	-
CP0351ASGEL	Single	CR-1 (Ø 3/16")	19 1/2	495	15 3/4	7.1	96	107
CP0351ASKEL	Single	CR-1 (Ø 3/16")	21 5/8	549	19 3/4	9.0	96	107
CP0351ASVEL	Single	CR-1 (Ø 3/16")	25 3/4	654	26 1/4	11.9	96	106
CP0351CUDEL	Single	CR-1 (Ø 3/16")	17 1/2	445	12 1/2	5.7	96	107
CP0351ESGEL	Tandem	CR-1 (Ø 3/16")	23 3/4	603	18 1/2	8.4	96	107
CP0351ESKEL	Tandem	CR-1 (Ø 3/16")	25 7/8	657	22 1/2	10.2	96	107
CP0351ESREL	Tandem	CR-1 (Ø 3/16")	27 7/8	708	27	12.2	96	107
CP0351ESVEL	Tandem	CR-1 (Ø 3/16")	30	762	29	13.2	96	107
CP0351FUDEL	Tandem	CR-1 (Ø 3/16")	21 3/4	552	15 1/4	6.9	96	107
CP0351PU	Single	n/a	21 1/2	546	20 1/2	9.3	96	107
CP0351CABHDY	Single	n/a	17 1/2	445	20 5/16	9.2	96	107

# Compression Tools – Rivet Sizes (Reference)

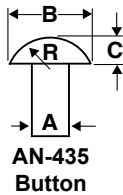

A		B		C		R	
in.	mm	in.	mm	in.	mm	in.	mm
<b>AN-435 A.S.A. BUTTON</b>							
3/32"	2.4	0.166	4.22	0.070	1.78	0.084	2.13
1/8"	3.2	0.219	5.56	0.094	2.39	0.111	2.82
5/32"	4.0	0.273	6.93	0.117	4.32	0.138	3.51
3/16"	4.8	0.328	8.33	0.141	3.58	0.166	4.22
1/4"	6.4	0.437	11.10	0.188	4.78	0.221	5.61
5/16"	7.9	0.546	13.87	0.234	5.94	0.276	7.01

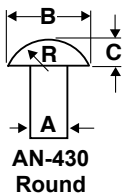

A		B		C		R	
in.	mm	in.	mm	in.	mm	in.	mm
<b>AN-430 ROUND</b>							
3/32"	2.4	0.187	4.75	0.070	1.78	0.098	2.49
1/8"	3.2	0.250	6.45	0.094	2.39	0.130	3.30
5/32"	4.0	0.312	7.92	0.117	2.97	0.162	4.11
3/16"	4.8	0.375	9.53	0.141	3.58	0.195	4.95
1/4"	6.4	0.500	12.70	0.188	4.78	0.260	6.60
5/16"	7.9	0.648	16.46	0.234	5.94	0.325	8.26

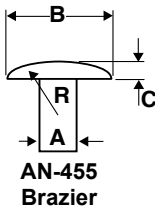

A		B		C		R	
in.	mm	in.	mm	in.	mm	in.	mm
<b>AN-455 BRAZIER</b>							
3/32"	2.4	0.234	5.94	0.047	1.19	0.170	4.32
1/8"	3.2	0.312	7.92	0.063	1.60	0.226	5.74
5/32"	4.0	0.390	9.90	0.078	1.98	0.283	7.19
3/16"	4.8	0.468	11.89	0.094	2.39	0.340	8.64
1/4"	6.4	0.625	15.83	0.125	3.18	0.453	11.51
5/16"	7.9	0.781	19.84	0.156	3.96	0.565	14.35

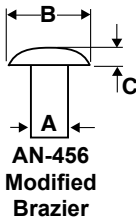

A		B		C	
in.	mm	in.	mm	in.	mm
<b>AN-456 MODIFIED BRAZIER</b>					
3/32"	2.4	0.156	3.96	0.031	7.90
1/8"	3.2	0.235	5.97	0.047	1.19
5/32"	4.0	0.312	7.92	0.063	1.60
3/16"	4.8	0.390	9.91	0.078	1.98
1/4"	6.4	0.468	11.89	0.094	2.39
5/16"	7.9	0.625	15.88	0.125	3.18

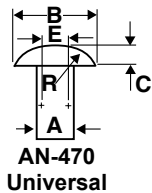

A		B		C		R		E	
in.	mm	in.	mm	in.	mm	in.	mm	in.	mm
<b>AN-470 UNIVERSAL</b>									
3/32"	2.4	0.187	4.75	0.041	1.04	0.082	2.08	0.047	1.19
1/8"	3.2	0.250	6.45	0.054	1.37	0.108	2.74	0.063	1.60
5/32"	4.0	0.312	7.92	0.067	1.70	0.135	3.43	0.078	1.98
3/16"	4.8	0.375	9.53	0.082	2.08	0.164	4.17	0.094	2.39
1/4"	6.4	0.500	12.70	0.107	2.72	0.217	5.51	0.125	3.18
5/16"	7.9	0.648	16.46	0.136	3.45	0.272	6.91	0.156	3.96

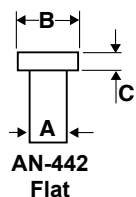

A		B		C	
in.	mm	in.	mm	in.	mm
<b>AN-442 FLAT</b>					
3/32"	2.4	0.187	4.75	0.037	0.94
1/8"	3.2	0.250	6.45	0.050	1.27
5/32"	4.0	0.312	7.92	0.062	1.57
3/16"	4.8	0.375	9.53	0.075	1.91
1/4"	6.4	0.500	12.70	0.100	2.54
5/16"	7.9	0.648	16.46	0.125	3.18