

Extract from our online catalogue:

## Ics-130/DD/QP

Current to: 2016-11-18



Ultrasonic sensors in the LCS series in cuboidal housing with lateral sound exit are available in three device variants with three different detection ranges.

## HIGHLIGHTS

- › Up to 3 pnp switching outputs
- › Automatic synchronisation › for simultaneous operation of up to ten sensors in close quarters

## BASICS

- › 2 or 3 switching outputs in pnp variant
- › Analogue output 4–20 mA and 0–10 V › with automatic switching between current and voltage outputs
- › 3 detection ranges with a measurement range of 30 mm to 2 m
- › microsonic Teach-in on pin 5
- › 0.18 mm resolution
- › Temperature compensation
- › 9–30 V operating voltage
- › LinkControl › for configuration of sensors from a PC

# Description

## The lcs sensors

have a block-like plastic housing with four fixation bores, two of which are already equipped with M4 threaded bushings for eased mounting.

## Two or three LEDs

indicate all operating statuses.

## Three detection ranges and two output stages are available for selection:



2 pnp switched outputs

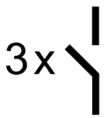

3 pnp switched outputs



1 analogue output 4–20 mA and 0–10 V

## Via pin 5 at the M12 circular connector,

(Com input), the lcs sensors are set (Teach-in): Switched output D1 is set by connecting pin 5 to  $+U_B$ , while switched output D2 is set by connecting pin 5 to  $-U_B$ . Also the sensors with analogue output are set via pin 5.

## The lcs sensors with switched output offer three operating modes:

- › Single switching point
- › Two-way reflective barrier
- › Window mode

## Teach-in of a single switching point

- › Place object to be detected (1) at the desired distance
- › Apply  $+U_B$  to pin 5 for about 3 seconds
- › Then apply  $+U_B$  to pin 5 again for about 1 seconds

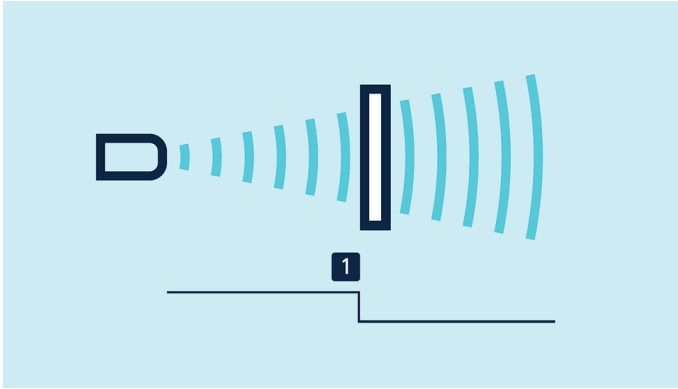

*Teach-in of a switching point*

### Teach-in of a two-way reflective barrier

with a fixed reflector

- › Apply  $+U_B$  to pin 5 for about 3 seconds
- › Then apply  $+U_B$  to pin 5 again for about 10 seconds

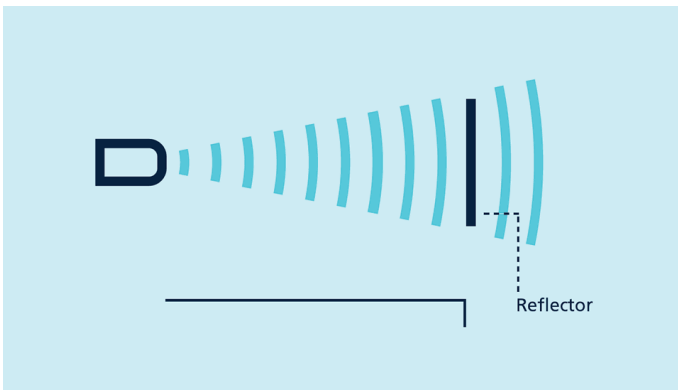

*Teach-in of a two-way reflective barrier*

### For configuration of a window

- › Place object at the near edge of the window (1)
- › Apply  $+U_B$  to pin 5 for about 3 seconds
- › Then move the object to the far edge of the window (2)
- › Then apply  $+U_B$  to pin 5 again for about 1 seconds

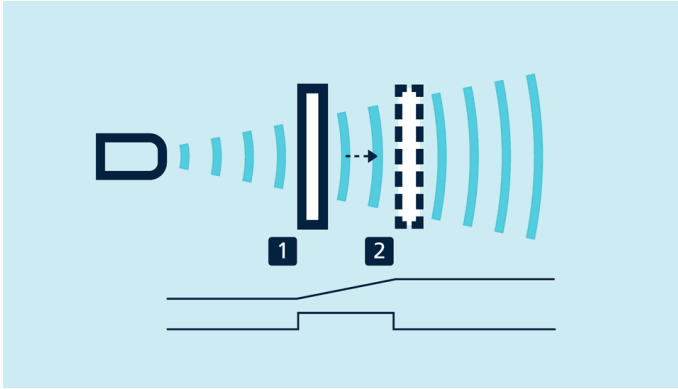

*Teach-in of an analogue characteristic or a window with two switching points*

## NCC/NOCC

and rising/falling analogue characteristic curve can also be set via pin 5.

## The analogue sensor

checks the load connected to the output and then automatically switch to 4–20 mA current output or 0–10 V voltage output to ensure maximum ease of handling.

## The Ics-25/DDD is equipped with three pnp switched outputs

which are set with the help of the Link-Control adapter LCA-2 (see LCA-2). In addition to this “offline” programming, all Ics sensors can also be parameterised on the PC with the LCA-2 and the Link-Control software.

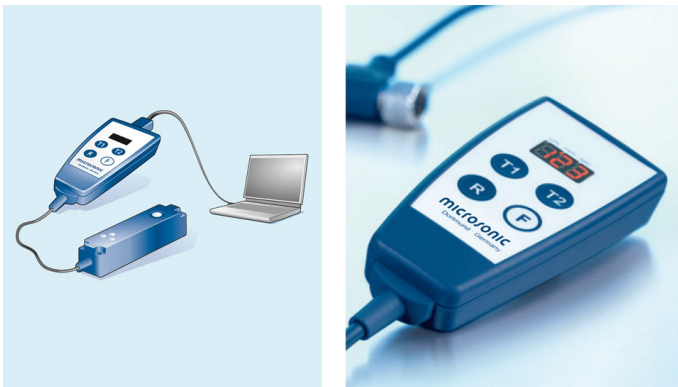

*Sensor connected to the PC via LCA-2 for programming*

## Synchronisation

permits the simultaneous use of multiple mic sensors in an application. To avoid mutual interference, the sensors can be synchronised with one another. To do this, all the sensors are electrically connected on pin 5.

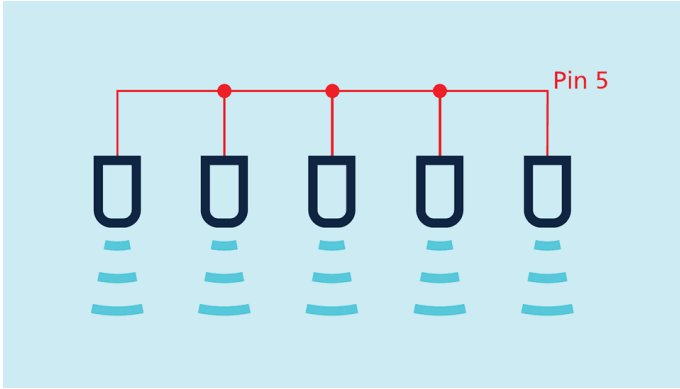

*Synchronisation using pin 5*

# Ics-130/DD/QP

## scale drawing

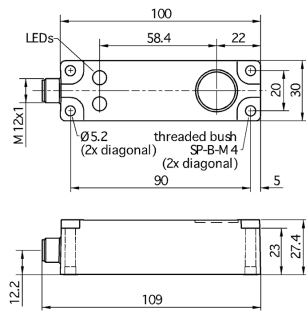

## detection zone

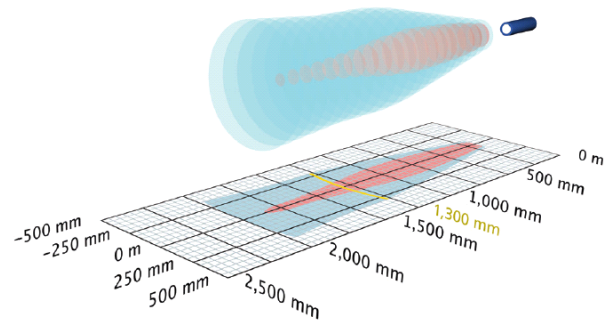

2 x pnp



2,000 mm

operating range	200 - 2.000 mm
design	cuboidal
operating mode	proximity switch/reflective mode reflective barrier window mode
particularities	flat housing lateral sound exit

## ultrasonic-specific

means of measurement	echo propagation time measurement
transducer frequency	200 kHz
blind zone	200 mm
operating range	1,300 mm
maximum range	2,000 mm
resolution/sampling rate	0.18 mm
reproducibility	± 0.15 %
accuracy	± 1 % (temperature drift internally compensated)

## electrical data

operating voltage $U_B$	9 - 30 V d.c., reverse polarity protection
voltage ripple	± 10 %
no-load current consumption	≤ 70 mA
type of connection	5-pin M12 initiator plug

# Ics-130/DD/QP

## outputs

output 1	switching output pnp: $I_{\max} = 200 \text{ mA}$ ( $U_B = 2V$ ) NOC/NCC adjustable, short-circuit-proof
output 2	switching output pnp: $I_{\max} = 200 \text{ mA}$ ( $U_B = 2V$ ) NOC/NCC adjustable, short-circuit-proof
switching hysteresis	20 mm
switching frequency	6 Hz
response time	110 ms
delay prior to availability	< 300 ms

## inputs

input 1	com input teach-in input
---------	-----------------------------

## housing

material	PBT
ultrasonic transducer	polyurethane foam, epoxy resin with glass contents
class of protection to EN 60529	IP 65
operating temperature	-25°C to +70°C
storage temperature	-40°C to +85°C
weight	200 g

## technical features/characteristics

temperature compensation	yes
controls	com input control input
scope for settings	Teach-in via com input on pin 5 LCA-2 with LinkControl
Synchronisation	yes
multiplex	no
indicators	2 x three-colour LED
particularities	flat housing lateral sound exit



# Ics-130/DD/QP

[documentation \(download\)](#)

## pin assignment

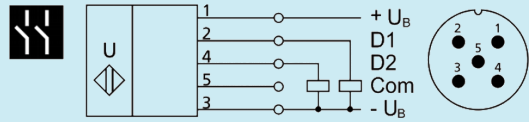

order no.

Ics-130/DD/QP