

Lovibond® Water Testing

Tintometer® Group



General Catalogue

**Instruments and Reagents
for Today's Water Analysis**

www.lovibond.com

PHILOSOPHY

„There are very few companies which can look back over a history of more than 130 years of success. The reason we can do so lies in the world-wide appreciation of our products and the determination of our work-force to maintain this“.

Cay-Peter Voss, CEO

Water is the basis of life. And it also provides the basis of our company and its activities. At Tintometer we have always specialized in scientific and technological products which make water analysis not just simple but also dependable and reliable.

For over 130 years we have concentrated on water testing and continue to set new standards in the market. More than 250 employees are working for our customers, meeting their requirements and achieving our vision: that research and development today will result in a better tomorrow.

Tintometer Group is one of the leading companies in the field of water analysis. Our trade-name Lovibond® is known in more than 140 countries, where we offer innovative products for the precise determination of different types of water : water in swimming pools, drinking water, waste water, surface and ground water, untreated water and effluents, through to cooling water and boiler water.



All around the world the highly-qualified and dedicated Tintometer team guarantees optimum equipment for any kind of water analysis. Our research and development department works closely with institutes in Germany, England, Switzerland, USA, Brazil, India, China and Malaysia. Together, we are constantly developing new, user-friendly water test systems which we bring to full production level in the shortest possible time.

Outstanding quality, maintained always at the highest level, forms the basis of all our work. And this applies not only to our products, which have been certified to DIN ISO 9001:2008 since 1997, but also to our service. The best proof of this is to ask our customers.

Sustainability and environmental protection



Tintometer places great importance on sustainability and the sensitive use of natural resources.

Environmental protection is one of the primary objectives of our organisation and we have therefore decided that, we shall issue our printed matter on FSC-certified paper.

Members of the Forest Stewardship Council (FSC) include environment associations, social organisations, forward-looking forestry companies and firms in the wood processing industry, working together to achieve improvements world-wide in the forestry field. The "FSC" quality seal is used to identify products manufactured from sustainably managed woods and forests.

In this way we make a further contribution to maintaining and improving our environment.



PRODUCTION

Dear Lovibond® Customer,

We are proud to present our general catalogue for Lovibond® water testing equipment, a comprehensive and invaluable source of information that details our full range of instruments, reagents and accessories, including separate sections for environmental monitoring and swimming pool testing. There is a detailed index that allows users to identify relevant product information by parameter and test method.

A Single Source for Water Testing Equipment

The Lovibond® range offers users a single source for equipment for the chemical analysis of water in all environments - potable and washing water, surface, ground and raw water, waste water and effluents, boiler and cooling water and swimming pools.

In particular the Lovibond® range presents a simple and flexible approach to routine water analysis that gives reliable results in both laboratory and field testing. It even includes the Vario range of reagents in the form of powder packs, which can be used in other manufacturers' photometers.



Ongoing Product Innovation and Development

We are committed to the ongoing development and improvement of our testing equipment and reagents. This commitment is demonstrated by the latest innovations of Tintometer: The BOD measurement system BD 600 for the automatically and direct control of waste water samples and the new photometers MD 610 & PM 630 with Bluetooth® interface. Both units based on a long experience in development of water testing systems and impress by origin Lovibond® quality.

Production Control and Assurance

All Lovibond® instruments, reagents and accessories are manufactured under our control, employing modern technology and QA procedures. Tintometer GmbH has been certified DIN ISO 9001:2008 since 1997.

Web Based Back-up

The information in this catalogue is supported and supplemented by our website – www.lovibond.com.

This includes the latest information on product developments and downloads of material safety data sheets and certificates of analysis.

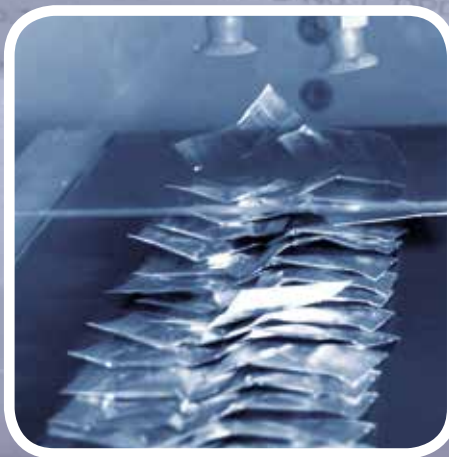

Content

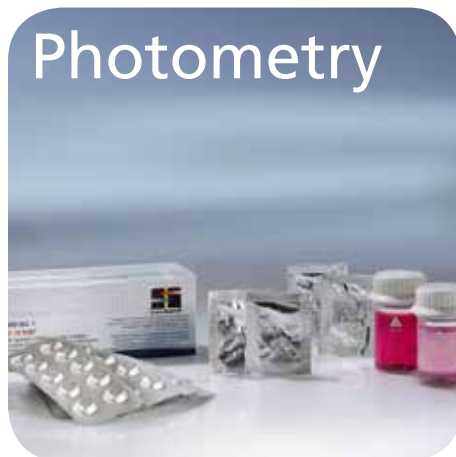

- 10** MINIKIT
- 11** Arsenic Test Kit
- 12** CHECKIT®
Comparator
- 26** Comparator
System 2000+

- 54** Photometer MD 100
- 58** Photometer MD 200
- 62** COD Setups COD VARIO
- 63** Thermoreactor RD 125
- 63** Waste Water Setups
- 64** Photometer
MD 600 & MD 610
- 68** Photometer MultiDirect
- 72** Spectrophotometer
SpectroDirect
- 76** Reagents for Photometer
- 100** Powder Dispenser PD 250
- 102** VARIO Powder Packs

- 108** BOD System BD 600



Cabinets

112 Thermostatically
Controlled Incubators

114 Spark-free Cabinets



Electrochemistry

116 SD 300 pH
SD 310 Oxi
SD 320 Con

120 SensoDirect 150

122 SensoDirect 110

124 SD Series



Turbidity

128 TB 300 IR

130 TB 210 IR

131 TB 250 WL



Flocculation

132 Floc Tester ET 740

132 Floc Tester ET 750

132 Floc Tester ET 730



Pool Products

136 Rapid Tests

140 Photometer
PM 600, PM 620 & PM 630

142 Applications of Reagents

148 Index

RAPID TESTS





MINIKIT



CHECKIT®
Comparator



Comparator 2000+



MINIKIT

Highlights

- Easy operation and exact reagent dosing
- High accuracy
- Foil-wrapped Lovibond® tablet reagents with a minimum guaranteed shelf life of 5 years
- Unrestricted shipment
- Safe storage



Analysis	Type	Range	Methods				Order code
			Tablet Count	Speed Test	Yes/No Test	Turbidity	
Alkalinity-M	AF 444	20 - 800 mg/l CaCO ₃ ≅ 0.4 - 16 mmol/l		■			41 44 40
Alkalinity Caustic/P	AF 415	20 - 500 mg/l CaCO ₃	■				41 41 50
Alkalinity-M	AF 413	10 - 500 mg/l CaCO ₃ ≅ 0.2 - 10 mmol/l	■				41 41 30
Alkalinity-P	AF 414	20 - 500 mg/l CaCO ₃	■				41 41 40
Calcium Hardness	AF 446	20- 800 mg/l CaCO ₃ ≅ 0.4 - 16 mmol/l		■			41 44 60
Calcium Hardness	AF 416	10- 500 mg/l CaCO ₃ ≅ 0.1 - 5 mmol/l	■				41 41 60
Chloride	AF 418	5 - 5000 mg/l Cl	■				41 41 80
Cleaning Acid Strength	AF 410	0.75-10% acid	■				41 41 00
Cyanuric Acid	AF 422	20 - 200 mg/l Cyanuric Acid				■	41 42 20
Hardness Total (very low range)	AF 426	1 - 10 mg/l CaCO ₃ ≅ 0.01 - 0.1 mmol/l	■				41 42 60
Hardness Total (low range)	AF 425	1 - 50 mg/l CaCO ₃ ≅ 0.01 - 0.5 mmol/l	■				41 42 50
Hardness Total (Yes/No)	AF 423	Limit 4 mg/l, 8 mg/l or 20 mg/l CaCO ₃ ≅ 0.04 or 0.08 or 0.2 mmol/l			■		41 42 30
Hardness Total	AF 445	20 - 800 mg/l CaCO ₃ ≅ 0.4 - 16 mmol/l		■			41 44 50
Hardness Total	AF 424	5 - 500 mg/l CaCO ₃ ≅ 0.05 - 5 mmol/l	■				41 42 40
Nitrite	AF 427	70 -1500 mg/l NaNO ₂	■				41 42 70
Organo-Phosphonate	AF 411	1 - 20 mg/l active O-P	■				41 41 10
QAC (Quaternary Ammonium Comp.)	AF 417	0 - 500 mg/l active QAC Limit 200 mg/l (Yes/No)	■		■		41 41 70
Sulphate (low range)	AF 432	20 - 200 mg/l Na ₂ SO ₄	■				41 43 20
Sulphate	AF 431	40 - 200 mg/l SO ₄ (40 - 4000 mg/l by dilution)				■	41 43 10
Sulphite (low range)	AF 434	2 - 50 mg/l Na ₂ SO ₃	■				41 43 40
Sulphite (high range)	AF 435	20 - 500 mg/l Na ₂ SO ₃	■				41 43 50
Tannin Index	AF 436	2 - 20 units	■				41 43 60

*BW: Boiler Water

The methods

The MINIKITS are designed for rapid water testing. Most MINIKITS are based on titrimetric methods.

Tablet count method

In the tablet count method, the liquid titration solution and indicator are replaced by Lovibond® tablet reagents. A specific number of tablets is added to a defined sample volume until a chemically induced colour change takes place. The concentration of the parameter being measured is calculated from the number of tablets required. The measuring range can be expanded by varying the sample volume.

Speed test

The speed test is based on reverse titration. After adding a reagent tablet to a calibrated test tube, the water sample is added slowly until the colour of the solution changes (e.g. from red to blue). The user can then obtain the result from the liquid level.

Yes/No test

A Yes/No test tells the user whether a specific ingredient is present in the water and/or if its concentration is higher or lower than a defined level.

Turbidity method

A two-section calibrated test tube is filled with the water sample and a reagent tablet added. The reagent creates a level of turbidity that is proportional to the concentration of the parameter being measured. The inner tube, which has a black dot on its base, is lowered until the dot is obscured by the turbidity. The result is read off from the water level in the inner tube.

Arsenic Test Kit (highly sensitive)

The arsenic test is due to its high sensitivity suitable for the determination of arsenic in drinking water.

The advantages at one view

- Sensitivity is according to the requirements of the WHO for drinking water quality. This test detects 0.005 mg/l Arsenic.
- The removal of the interfering sulfide ions is integrated in the test procedure. To minimize the potential danger for the user of the test kit it doesn't use the highly toxic lead acetate for the sulfide removal.
- A solid acid substance is used in order to avoid any irritation by a corrosive acid on the user's hands.
- The unbreakable plastic reaction vessel is more convenient and safe for on-site testing.
- During the test procedure the reaction vessel is tightly closed. The developing arsine gas cannot escape and therefore does not harm the user.
- The test kit contains a water-proof colour chart which also includes the brief instruction for use in pictograms. Even if there is a lack of knowledge in foreign languages everybody can now handle the test kit.

Resolution:

0 - 0.005 - 0.01 - 0.025 - 0.05 - 0.1 - 0.25 - 0.5 mg As^{3+/5+}/l

Kit for 100 measurements in case.

Order code: 40 07 00



Arsenic Test Kit, ready to use

Reagent	Order code	Quantity
ALK-TEST	51 55 70 BT	100
ALKALINITY-P-tablets	51 51 01	250
ALKALINITY-P (BaCl ₂)-tablets	51 51 10 BT	100
TOTAL ALKALINITY-tablets	51 53 21 BT	250
ALKALINITY-P-Tablets	51 51 01	250
CAL-TEST	51 55 80 BT	100
CALCIUM HARDNESS	51 51 91 BT	250
CHLORIDE	51 51 31	250
ACID CONCENTRATION	50 54 20	100
CyA-TEST	51 13 70 BT	100
HARDNESS VLR	51 53 51 BT	250
HARDNESS LR (BW)*	51 51 71 BT	250
HARDNESS YES / NO	51 53 61 BT	250
T HARDNESS-TEST	51 55 90 BT	100
TOTAL HARDNESS	51 51 61 BT	250
NITRITE No. 1	51 52 01 BT	250
NITRITE No. 2	51 52 11 BT	250
ORGANO-PHOSPHONATE No. 2	46 53 51	100 ml
ORGANO-PHOSPHONATE No. 1	51 29 61 BT	250
QAC-Test	51 54 10	100
	51 54 11	250
SULFATE No. 1	51 52 21	250
SULFATE No. 2	51 52 31	250
SULFATE T	51 54 51 BT	250
SULFITE No. 1	51 52 71 BT	250
SULFITE No. 2 HR	51 52 81 BT	250
SULFITE No. 2 LR (BW)*	51 53 31 BT	250
TANNIN No. 1	50 35 00	100
TANNIN No. 2	50 35 11	250

CHECKIT[®] Comparator



Applications

- Water Treatment (e.g. Drinking Water)
- Pools
- Laboratory and Field Testing
- Special Applications

Discs with continuous colour scale

- low cost
- precise
- reliable



Front view of the CHECKIT®Comparator with cells



Test Kit complete in case



Plastic cells, frosted on two sides, volume 10 ml, path length 13.5 mm, with lid



Tablet reagents in blister



CHECKIT®Discs with continuous colour scales

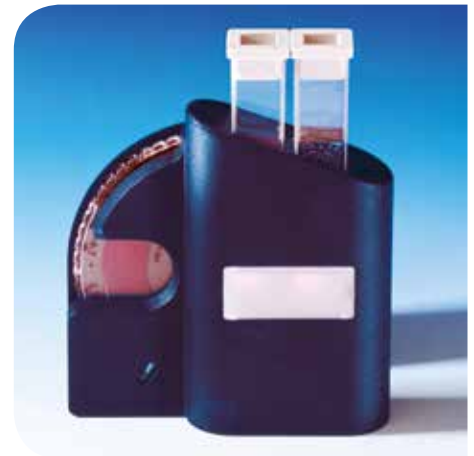

Rear view of the CHECKIT®Comparator with disc, diffuser and cells

CHECKIT®Comparator

The Lovibond® CHECKIT®Comparator is a compact and handy colorimetric unit which is suitable both for mobile and stationary analysis work. Supplied with a generous number of different colour scales, it provides the basis for a comprehensive, easy-to-use colorimetric analysis system.

The CHECKIT®Comparator D55 enables the use of large path lengths. The mirror optics makes use of the view through the entire length of the cell.

CHECKIT®Disc

Each CHECKIT®Disc contains a continuous colour scale which makes it possible to achieve an exact colour match between the colour standard and the sample. These CHECKIT®Discs are specially manufactured in selected materials to remain colour-stability over a long period and guarantee reliable, reproducible measurement results.

Instruction manuals explaining the various stages of analysis in simple, straightforward terms, are supplied with each CHECKIT®Disc.

➔ Please see pages 16 onwards for tests, ranges and reagents

Highlights

- Easy operation
- Exact reagent dosing
- Tablet reagents with a minimum guaranteed shelf life of 5/10 years
- High accuracy
- Continuous colour scale

CHECKIT® Comparator

Regular
Testing to
observe the
Water Quality



Test Kits 2 in 1

Together with the CHECKIT® Comparator, each test kit includes CHECKIT® Discs, cells, stirring rod and Lovibond® reagents (for 30 tests) for the desired test.

The test kits are supplied in a sturdy and handy plastic case.

The operating instructions provide a step-by-step explanation of how to conduct the water test, ensuring that even "non-chemists" can achieve reliable and accurate measurements in the minimum of time.

Test-Kits	Code
Chlorine 0 – 1.0 mg/l Cl ₂ pH value 6.5 – 8.4 pH Pool version	14 70 15 14 70 16
Chlorine 0.1 – 2.0 mg/l Cl ₂ pH value 6.5 – 8.4 pH Pool version	14 70 45 14 70 46
Chlorine 0 – 4.0 mg/l Cl ₂ pH value 6.5 – 8.4 pH Pool version	14 70 25 14 70 26
Bromine 0 – 5.0 mg/l Br pH value 6.5 – 8.4 pH	14 72 85
Copper 0 – 1.0 mg/l Cu pH value 6.5 – 8.4 pH	14 72 35

Test-Kit 5 in 1

Test-Kits	Code
Chlorine 0 – 4.0 mg/l Cl ₂ pH value 6.5 – 8.4 pH Cyanuric acid (Turbidity method)* 20 – 200 mg/l Cys Calcium hardness (Speed-Test)* 20 – 800 mg/l CaCO ₃ Total Alkalinity (M) (Speed-Test)* 20 – 800 mg/l CaCO ₃	14 70 28

Disc readings see following pages.

All test kits for chlorine are for "free, combined and total chlorine".

*Reagents for turbidity method and speed test (Test-Kit 5 in 1) see MINIKIT.



Single Parameter Test Kits

Test	Range* (Accuracy ± 5 % F.S.)	Code
Aluminium	0 - 0.3 mg/l Al	14 72 00
Ammonia	0 - 1 mg/l N	14 72 10
Ammonia , Powder Pack	0 - 0.5 mg/l N	14 72 11
Bromine	0 - 5 mg/l Br	14 72 80
Chlorine (DPD)** free, combined, total	0.02 - 0.3 mg/l Cl ₂	14 70 00
Chlorine (DPD) free, combined, total	0 - 1 mg/l Cl ₂	14 70 10
Chlorine (DPD) free, combined, total	0 - 2 mg/l Cl ₂	14 70 40
Chlorine, free (DPD), Powder Pack	0 - 3.5 mg/l Cl ₂	14 70 50
Chlorine, total (DPD), Powder Pack	0 - 3.5 mg/l Cl ₂	14 70 51
Chlorine, free + total (DPD), Powder Packs	0 - 3.5 mg/l Cl ₂	14 70 52
Chlorine (DPD) free, combined, total	0 - 4 mg/l Cl ₂	14 70 20
Chlorine KI	10 - 300 mg/l Cl ₂ (total)	14 70 30
Chlorine dioxide**	0.01 - 0.2 mg/l ClO ₂	14 73 30
Copper, free (Cu²⁺)	0 - 1 mg/l Cu	14 72 30
Copper HR , free + total	0 - 5 mg/l Cu	14 74 30
Copper HR , free, Powder Pack	0 - 5 mg/l Cu	14 74 31
Copper LR** , free + total	0 - 1 mg/l Cu	14 74 40
Copper LR** , free, Powder Pack	0 - 1 mg/l Cu	14 74 41
DEHA	0 - 0.5 mg/l DEHA	14 73 70
Fluoride , Testpak available only	0.2 - 2 mg/l F ⁻	
Iron HR	1 - 10 mg/l Fe	14 73 20
Iron LR	0.05 - 1 mg/l Fe	14 72 20
Iron (TPTZ) , Powder Pack	0 - 1.8 mg/l Fe	14 74 70
Manganese LR , Testpak available only	0.1 - 0.7 mg/l Mn	
Manganese VLR , Testpak available only	0.02 - 0.2 mg/l Mn	
Molybdate LR**	0 - 10 mg/l MoO ₄	14 72 91
Molybdate HR	0 - 100 mg/l MoO ₄	14 72 90
Molybdate HR	50 - 500 mg/l MoO ₄	14 72 95
Nitrate LR , Testpak available only	0 - 1 mg/l NO ₃	
Nitrite LR	0 - 0.5 mg/l N	14 73 00
Nitrite , Powder Pack	0 - 0.3 mg/l N	14 73 01
Ozone (DPD), in the presence of chlorine	0 - 1.0 mg/l O ₃	14 72 70
Ozone (DPD)	0 - 1.0 mg/l O ₃	14 72 75
pH value (Phenol red)	6.5 - 8.4 pH	14 71 00
pH value (Bromocresol purple)	5.2 - 6.8 pH	14 71 10
pH value (Bromothymol blue)	6.0 - 7.6 pH	14 71 20
pH value (Universal)	4 - 10 pH	14 71 30
Phosphate , Powder Pack	0 - 2.5 mg/l PO ₄	14 74 80
Phosphate HR	0 - 80 mg/l PO ₄	14 72 50
Phosphate LR	0 - 4 mg/l PO ₄	14 72 40
Silica LR	0.25 - 4 mg/l SiO ₂	14 73 50
Silica HR , Powder Pack	0 - 100 mg/l SiO ₂	14 73 51
Silica VLR**	0 - 1 mg/l SiO ₂	14 73 60
Sodiumhypochlorite	2 - 18 %	14 74 90
Sulfite LR	0.5 - 10 mg/l SO ₃	14 73 80
Total Alkalinity	20 - 240 mg/l CaCO ₃	14 74 50
Zinc LR	0 - 1 mg/l Zn	14 73 40

* Disc readings see following pages

** Only with CHECKIT® Comparator D55 with mirror optics (path length 55 mm)

Testpak

The Testpak is a simple and cost-effective means of extending the use of an existing CHECKIT® Comparator instrument to a new test parameter.

Each Testpak contains the required CHECKIT® Disc, tablet reagents (normally for 30 tests), two cells, stirring rod and detailed instructions for the desired method.

Please contact our sales departments for further information: sales@tintometer.de

CHECKIT[®] Comparator

Tests, Test Kits, Testpaks, Discs, Reagents

Test	Range	Readings (Accuracy ± 5 % Full Scale)	Test Kit	Testpak
Aluminium	0 - 0.3 mg/l Al	0 / 0.01 / 0.02 / 0.03 / 0.04 / 0.05 / 0.06 / 0.07 / 0.08 / 0.09 / 0.1 / 0.15 / 0.2 / 0.25 / 0.3	14 72 00	14 77 00
Ammonia	0 - 1 mg/l N	0 / 0.05 / 0.1 / 0.15 / 0.2 / 0.25 / 0.3 / 0.35 / 0.4 / 0.45 / 0.5 / 0.55 / 0.6 / 0.65 / 0.7 / 0.75 / 0.8 / 0.9 / 0.95 / 1.0	14 72 10	14 77 10
Ammonia VARIO	0 - 0.5 mg/l N	0 / 0.05 / 0.1 / 0.15 / 0.2 / 0.25 / 0.3 / 0.35 / 0.4 / 0.45 / 0.5	14 72 11	14 77 11
Bromine	0 - 5 mg/l Br	0 / 0.2 / 0.4 / 0.6 / 0.8 / 1.0 / 1.2 / 1.4 / 1.6 / 1.8 / 2 / 2.5 / 3 / 3.5 / 4 / 4.5 / 5	14 72 80	14 77 80
Chlorine free, combined**, total	0 - 1 mg/l Cl ₂	0 / 0.05 / 0.1 / 0.15 / 0.2 / 0.25 / 0.3 / 0.35 / 0.4 / 0.45 / 0.5 / 0.55 / 0.6 / 0.65 / 0.7 / 0.75 / 0.8 / 0.85 / 0.9 / 0.95 / 1.0	14 70 10	14 75 10
Chlorine free, combined**, total	0 - 2 mg/l Cl ₂	0.1 / 0.2 / 0.3 / 0.4 / 0.5 / 0.6 / 0.7 / 0.8 / 0.9 / 1.0 / 1.1 / 1.2 / 1.3 / 1.4 / 1.6 / 1.8 / 2.0	14 70 40	14 75 40
Chlorine free, combined**, total	0 - 4 mg/l Cl ₂	0 / 0.2 / 0.4 / 0.6 / 0.8 / 1.0 / 1.2 / 1.4 / 1.6 / 1.8 / 2.0 / 2.5 / 3.0 / 3.5 / 4.0	14 70 20	14 75 20
Chlorine free, combined**, total	0 - 3.5 mg/l Cl ₂	0 / 0.2 / 0.4 / 0.6 / 0.8 / 1 / 1.2 / 1.4 / 1.6 / 1.8 / 2 / 2.2 / 2.4 / 2.6 / 2.8 / 3 / 3.2 / 3.4 / 3.5	14 70 52	14 75 50, free 14 75 51, total
Chlorine free, combined**, total	0.02 - 0.3 mg/l Cl ₂	0.02 / 0.03 / 0.04 / 0.05 / 0.06 / 0.07 / 0.08 / 0.09 / 0.1 / 0.11 / 0.12 / 0.13 / 0.14 / 0.15 / 0.16 / 0.17 / 0.18 / 0.19 / 0.2 / 0.22 / 0.24 / 0.26 / 0.28 / 0.3	14 70 00	14 75 00
** maybe calculated by deducting free from total chlorine		only with CHECKIT [®] Comparator D55 with mirror optics (path length 55 mm)		

* RAPID: fast dissolving tablet
including stirring rod

Disc	Reagents	Quantity	Code
14 62 00	ALUMINIUM No.1	100	51 54 60 BT
		250	51 54 61 BT
	ALUMINIUM No.2	100	51 54 70 BT
		250	51 54 71 BT
	Combi pack [#] ALUMINIUM No.1 / No.2	each 100 each 250	51 76 01 BT 51 76 02 BT
14 62 10	AMMONIA No.1	100	51 25 80 BT
		250	51 25 81 BT
	AMMONIA No.2	100	51 25 90 BT
		250	51 25 91 BT
	Combi pack [#] AMMONIA No.1 / No.2	each 100 each 250	51 76 11 BT 51 76 12 BT
14 62 11	VARIO Ammonia Salicylate F10 VARIO Ammonia Cyanurate F10	Powder Pack / 200 Powder Pack / 200 Set	53 55 00
14 62 80	DPD No.1-RAPID*	100	51 13 10 BT
		250	51 13 11 BT
		500	51 13 12 BT
14 60 10	DPD No.1-RAPID*	100	51 13 10 BT
		250	51 13 11 BT
		500	51 13 12 BT
	DPD No.3-RAPID*	100	51 12 90 BT
		250	51 12 91 BT
	DPD No.4-RAPID*	500	51 12 92 BT
		100	51 15 70 BT
	250	51 15 71 BT	
	500	51 15 72 BT	
14 60 40	DPD No.1/3/4-RAPID*		
14 60 20	DPD No.1/3/4-RAPID*		
14 60 50	VARIO Chlorine Free DPD F5	100	53 00 90
	VARIO Chlorine Total DPD F5	100	53 00 80
14 60 00	DPD No.1	100	51 10 50 BT
		250	51 10 51 BT
		500	51 10 52 BT
	DPD No.3	100	51 10 80 BT
		250	51 10 81 BT
		500	51 10 82 BT
	Combi pack [#] DPD No.1 / No.3	each 100 each 250	51 77 11 BT 51 77 12 BT



CHECKIT®Discs

Material Safety Data Sheets: www.lovibond.com

[†] additionally required for determination of chlorine dioxide / ozone in the presence of chlorine

CHECKIT® Comparator

Tests, Test Kits, Testpaks, Discs, Reagents

Test	Range	Readings (Accuracy ± 5 % Full Scale)	Test Kit	Testpak
Chlorine KI total only	10 - 300 mg/l Cl ₂	10 / 20 / 30 / 40 / 50 / 60 / 70 / 80 / 90 / 100 / 110 / 120 / 130 / 140 / 150 / 160 / 170 / 180 / 190 / 200 / 250 / 300	14 70 30	14 75 30
Chlorine dioxide	0.01 - 0.2 mg/l ClO ₂	0.01 / 0.02 / 0.03 / 0.04 / 0.05 / 0.06 / 0.07 / 0.08 / 0.09 / 0.1 / 0.11 / 0.12 / 0.13 / 0.14 / 0.15 / 0.16 / 0.17 / 0.18 / 0.19 / 0.2 only with CHECKIT® Comparator D55 with mirror optics (path length 55 mm)	14 73 30	14 78 30
Copper, free (Cu²⁺)	0 - 1 mg/l Cu	0 / 0.1 / 0.2 / 0.3 / 0.4 / 0.5 / 0.6 / 0.7 / 0.8 / 0.9 / 1.0	14 72 30	14 77 30
Copper HR free and total	0 - 5 mg/l Cu	0 / 0.5 / 1.0 / 1.5 / 2.0 / 2.5 / 3.0 / 3.5 / 4.0 / 4.5 / 5.0	14 74 30	14 79 30
Copper HR, free only	0 - 5 mg/l Cu	0 / 0.5 / 1 / 1.5 / 2 / 2.5 / 3 / 3.5 / 4 / 5	14 74 31	14 79 31
Copper LR free and total	0 - 1 mg/l Cu	0 / 0.1 / 0.2 / 0.3 / 0.4 / 0.5 / 0.6 / 0.7 / 0.8 / 0.9 / 1.0 only with CHECKIT® Comparator D55 with mirror optics (path length 55 mm)	14 74 40	14 79 40
Copper LR, free only	0 - 1 mg/l Cu	0 / 0.05 / 0.1 / 0.15 / 0.2 / 0.25 / 0.3 / 0.35 / 0.4 / 0.45 / 0.5 / 0.6 / 0.7 / 0.8 / 0.9 / 1.0 only with CHECKIT® Comparator D55 with mirror optics (path length 55 mm)	14 74 41	14 79 41
DEHA	0 - 0.5 mg/l DEHA	0 / 0.05 / 0.1 / 0.15 / 0.2 / 0.25 / 0.3 / 0.35 / 0.4 / 0.45 / 0.5	14 73 70	14 78 70
Fluoride	0.2 - 2 mg/l F	0.2 / 0.4 / 0.6 / 0.8 / 1.0 / 1.2 / 1.4 / 1.6 / 1.8 / 2.0	-----	14 78 90

Testpak available only

* RAPID: fast dissolving tablet

including stirring rod

Disc	Reagents	Quantity	Code
14 60 30	CHLORINE HR (KI)	100	51 30 00 BT
		250	51 30 01 BT
	ACIDIFYING GP	100	51 54 80 BT
		250	51 54 81 BT
	Combi pack [#] CHLORINE HR (KI)/ACIDIFYING GP	each 100 each 250	51 77 21 BT 51 77 22 BT
14 63 30	DPD No. 1	100	51 10 50 BT
		250	51 10 51 BT
	DPD Glycine ^{†)}	100	51 21 70 BT
		250	51 21 71 BT
	Combi pack [#] DPD No.1 / GLYCINE	each 100 each 250	51 77 31 BT 51 77 32 BT
14 62 30	COPPER/ZINC LR	100	51 26 20 BT
		250	51 26 21 BT
14 64 30	COPPER No. 1	100	51 35 50 BT
		250	51 35 51 BT
	COPPER No. 2	100	51 35 60 BT
		250	51 35 61 BT
	Combi pack [#] COPPER No.1 / No.2	each 100 each 250	51 76 91 BT 51 76 92 BT
14 64 31	Vario Cu1 F10	100	53 03 00
14 64 40	COPPER No. 1	100	51 35 50 BT
		250	51 35 51 BT
	COPPER No. 2	100	51 35 60 BT
		250	51 35 61 BT
	Combi pack [#] COPPER No.1 / No.2	each 100 each 250	51 76 91 BT 51 76 92 BT
14 64 41	Vario Cu1 F10	100	53 03 00
14 63 70	DEHA	100	51 32 20 BT
		250	51 32 21 BT
	DEHA solution	15 ml	46 11 85
	DEHA solution	100 ml	46 11 81
	Plastic funnel with handle	1	47 10 07
14 63 90	SPADNS reagent solution	250 ml	46 74 81
		500 ml	46 74 82
	Help for pipette	1	36 50 55
	Pipette 2 ml	1	36 50 50



Test Kit complete in case

Material Safety Data Sheets: www.lovibond.com

^{†)} additionally required for determination of chlorine dioxide / ozone in the presence of chlorine

CHECKIT[®] Comparator

Tests, Test Kits, Testpaks, Discs, Reagents

Test	Range	Readings (Accuracy ± 5 % Full Scale)	Test Kit	Testpak
Iron LR	0 - 1 mg/l Fe	0.05 / 0.1 / 0.15 / 0.2 / 0.25 / 0.3 / 0.35 / 0.4 / 0.45 / 0.5 / 0.55 / 0.6 / 0.65 / 0.7 / 0.75 / 0.8 / 0.9 / 1.0	14 72 20	14 77 20
Iron HR	1 - 10 mg/l Fe	1 / 1.5 / 2 / 2.5 / 3 / 3.5 / 4 / 4.5 / 5 / 5.5 / 6 / 6.5 / 7 / 7.5 / 8 / 8.5 / 9 / 10	14 73 20	14 78 20
Iron (TPTZ)	0 - 1.8 mg/l Fe	0.1 / 0.2 / 0.3 / 0.4 / 0.5 / 0.6 / 0.7 / 0.8 / 0.9 / 1 / 1.1 / 1.2 / 1.3 / 1.4 / 1.5 / 1.6 / 1.7 / 1.8	14 74 70	14 79 70
Manganese LR Testpak available only	0.1 - 0.7 mg/l Mn	0.1 / 0.15 / 0.2 / 0.25 / 0.3 / 0.35 / 0.4 / 0.45 / 0.5 / 0.55 / 0.6 / 0.65 / 0.7	-----	14 79 10
Manganese VLR Testpak available only	0.02 - 0.2 mg/l Mn	0.02 / 0.03 / 0.04 / 0.05 / 0.06 / 0.07 / 0.08 / 0.09 / 0.1 / 0.11 / 0.12 / 0.13 / 0.14 / 0.15 / 0.16 / 0.18 / 0.2	-----	14 79 20
		only with CHECKIT [®] Comparator D55 with mirror optics (path length 55 mm)		
Molybdate HR	0 - 100 mg/l MoO ₄	0 / 5 / 10 / 15 / 20 / 25 / 30 / 35 / 40 / 45 / 50 / 55 / 60 / 65 / 70 / 75 / 80 / 85 / 90 / 95 / 100	14 72 90	14 77 90
Molybdate HR	50 - 500 mg/l MoO ₄	50 / 100 / 150 / 200 / 250 / 300 / 500	14 72 95	14 77 95
Molybdate LR	0 - 10 mg/l MoO ₄	0 / 1 / 2 / 3 / 4 / 5 / 6 / 7 / 8 / 9 / 10	14 72 91	14 77 91
		only with CHECKIT [®] Comparator D55 with mirror optics (path length 55 mm)		

* RAPID: fast dissolving tablet
including stirring rod

Disc	Reagents	Quantity	Code
14 62 20	IRON LR (Fe ²⁺ and Fe ³⁺)	100	51 53 70 BT
		250	51 53 71 BT
	IRON (II) LR (Fe ²⁺)	100	51 54 20 BT
14 63 20	IRON HR	100	51 53 80 BT
		250	51 53 81 BT
14 64 70	Vario Iron TPTZ F10	100	53 05 50
14 64 10	VARIO Manganese Reagent, LR F10	1 Set	53 50 90
	consists of:		
	VARIO Alkaline-Cyanide Solution	60 ml	
	Vario Ascorbic Acid	100	
	Vario PAN Indicator Solution	60 ml	
Accessories:	VARIO Rochelle Salt Solution	30 ml	53 06 40
	needs for samples with hardness values above 300 mg/l CaCO ₃		
14 64 20	VARIO Manganese Reagent, LR F10	1 Set	53 50 90
	consists of:		
	VARIO Alkaline-Cyanide Solution	60 ml	
	Vario Ascorbic Acid	100	
	Vario PAN Indicator Solution	60 ml	
Accessories:	VARIO Rochelle Salt Solution	30 ml	53 06 40
	needs for samples with hardness values above 300 mg/l CaCO ₃		
14 62 90	MOLYBDATE No. 1 HR	100	51 30 60 BT
		250	51 30 61 BT
	MOLYBDATE No. 2 HR	100	51 30 70 BT
		250	51 30 71 BT
	Combi pack [#]	each 100	51 76 31 BT
MOLYBDATE No.1 HR / No.2 HR	each 250	51 76 32 BT	
14 62 95	MOLYBDATE No. 1 HR	100	51 30 60 BT
		250	51 30 61 BT
	MOLYBDATE No. 2 HR	100	51 30 70 BT
		250	51 30 71 BT
	Combi pack [#]	each 100	51 76 31 BT
MOLYBDATE No.1 HR / No.2 HR	each 250	51 76 32 BT	
14 62 91	MOLYBDATE No. 1 HR	100	51 30 60 BT
		250	51 30 61 BT
	MOLYBDATE No. 2 HR	100	51 30 70 BT
		250	51 30 71 BT
	Combi pack [#]	each 100	51 76 31 BT
MOLYBDATE No.1 HR / No.2 HR	each 250	51 76 32 BT	



Plastic cells, volume 10 ml

Material Safety Data Sheets: www.lovibond.com

[†] additionally required for determination of chlorine dioxide / ozone in the presence of chlorine

CHECKIT[®] Comparator

Tests, Test Kits, Testpaks, Discs, Reagents

Test	Range	Readings (Accuracy ± 5 % Full Scale)	Test Kit	Testpak
Nitrate LR Testpak available only	0 - 1 mg/l N	0 / 0.1 / 0.2 / 0.3 / 0.4 / 0.5 / 0.6 / 0.7 / 0.8 / 0.9 / 1.0	-----	14 78 10
Nitrite LR	0 - 0.5 mg/l N	0 / 0.05 / 0.1 / 0.15 / 0.2 / 0.25 / 0.3 / 0.35 / 0.4 / 0.45 / 0.5	14 73 00	14 78 00
Nitrite VARIO	0 - 0.3 mg/l N	0 / 0.01 / 0.02 / 0.03 / 0.04 / 0.05 / 0.06 / 0.07 / 0.08 / 0.09 / 0.10 / 0.11 / 0.12 / 0.13 / 0.14 / 0.15 / 0.16 / 0.17 / 0.18 / 0.19 / 0.20 / 0.21 / 0.22 / 0.23 / 0.24 / 0.25 / 0.26 / 0.27 / 0.28 / 0.29 / 0.30	14 73 01	14 78 01
Ozone (DPD) in the presence of chlorine	0 - 1.0 mg/l O ₃	0 / 0.05 / 0.1 / 0.15 / 0.2 / 0.25 / 0.3 / 0.35 / 0.4 / 0.45 / 0.5 / 0.55 / 0.6 / 0.65 / 0.7 / 0.75 / 0.8 / 0.9 / 1.0	14 72 70	14 77 70
Ozone (DPD)	0 - 1.0 mg/l O ₃	0 / 0.05 / 0.1 / 0.15 / 0.2 / 0.25 / 0.3 / 0.35 / 0.4 / 0.45 / 0.5 / 0.55 / 0.6 / 0.65 / 0.7 / 0.75 / 0.8 / 0.9 / 1.0	14 72 75	14 77 75
pH	5.2 - 6.8 pH 6.0 - 7.6 pH 6.5 - 8.4 pH	5.2 / 5.3 / 5.4 / 5.5 / 5.6 / 5.7 / 5.8 / 5.9 / 6.0 / 6.1 / 6.2 / 6.3 / 6.4 / 6.5 / 6.6 / 6.7 / 6.8 6.0 / 6.1 / 6.2 / 6.3 / 6.4 / 6.5 / 6.6 / 6.7 / 6.8 / 6.9 / 7.0 / 7.1 / 7.2 / 7.3 / 7.4 / 7.5 / 7.6 6.5 / 6.6 / 6.7 / 6.8 / 6.9 / 7.0 / 7.1 / 7.2 / 7.3 / 7.4 / 7.5 / 7.6 / 7.7 / 7.8 / 7.9 / 8.0 / 8.1 / 8.2 / 8.3 / 8.4	14 71 10 14 71 20 14 71 00	14 76 10 14 76 20 14 76 00
pH-Universal	4 - 10 pH	4 / 4.5 / 5 / 5.5 / 6 / 6.5 / 7 / 7.5 / 8 / 8.5 / 9 / 9.5 / 10	14 71 30	14 76 30
Phosphate HR	0 - 80 mg/l PO ₄	0 / 5 / 10 / 15 / 20 / 25 / 30 / 35 / 40 / 45 / 50 / 55 / 60 / 65 / 70 / 75 / 80	14 72 50	14 77 50
Phosphate LR	0 - 4 mg/l PO ₄	0 / 0.25 / 0.5 / 0.75 / 1.0 / 1.25 / 1.5 / 1.75 / 2.0 / 2.25 / 2.5 / 2.75 / 3.0 / 3.25 / 3.5 / 3.75 / 4.0	14 72 40	14 77 40
Phosphate	0 - 2.5 mg/l PO ₄	0 / 0.1 / 0.2 / 0.3 / 0.4 / 0.5 / 0.6 / 0.7 / 0.8 / 0.9 / 1 / 1.1 / 1.2 / 1.3 / 1.4 / 1.5 / 1.6 / 1.7 / 1.8 / 1.9 / 2 / 2.1 / 2.2 / 2.3 / 2.4 / 2.5	14 74 80	14 79 80

* RAPID: fast dissolving tablet
including stirring rod

Disc	Reagents	Quantity	Code
14 63 10	NITRITE LR	100	51 23 10BT
		250	51 23 11BT
	NITRATE-Test tablets	100 (bottle)	50 28 10
	NITRATE Test powder	15 g	46 52 30
	NITRATE Test tube	1	36 62 20
14 63 00	NITRITE LR	100	51 23 10BT
		250	51 23 11BT
14 63 01	VARIO Nitri 3 F10	Powder Pack / 100	53 09 80
14 62 70	DPD No. 4	100	51 12 20 BT
		250	51 12 21 BT
	DPD Glycine ^{†)}	100	51 21 70 BT
		250	51 21 71 BT
14 62 75	DPD No. 4	100	51 12 20 BT
		250	51 12 21 BT
14 61 10	BROMOCRESOL PURPLE	100	51 17 30
		250	51 17 31
14 61 20	BROMOTHYMOL BLUE	100	51 16 40 BT
		250	51 16 41 BT
14 61 00	PHENOL RED-RAPID*	100	51 17 90 BT
		250	51 17 91 BT
14 61 30	UNIVERSAL PH	100	51 54 40
		250	51 54 41
14 62 50	PHOSPHATE HR	100	51 19 80
14 62 40	PHOSPHATE No. 1 LR	100	51 30 40
	PHOSPHATE No. 2 LR	100	51 30 50 BT
	Combi pack [#]	each 100	51 76 51 BT
	PHOSPHATE No.1 LR / No.2 LR		
14 64 80	Vario PHOS 3 F10	100	53 15 50



CHECKIT®Comparator with powder reagent/ tablets

Material Safety Data Sheets: www.lovibond.com

^{†)} additionally required for determination of chlorine dioxide / ozone in the presence of chlorine

CHECKIT[®] Comparator

Tests, Test Kits, Testpaks, Discs, Reagents

Test	Range	Readings (Accuracy ± 5 % Full Scale)	Test Kit	Testpak
Silica LR	0.25 - 4 mg/l SiO ₂	0.25 / 0.5 / 0.75 / 1.0 / 1.25 / 1.5 / 1.75 / 2.0 / 2.5 / 3.0 / 3.5 / 4	14 73 50	14 78 50
Silica HR VARIO	0 - 100 mg/l SiO ₂	0 / 10 / 20 / 30 / 40 / 50 / 60 / 70 / 80 / 90 / 100	14 73 51	14 78 51
Silica VLR	0 - 1 mg/l SiO ₂	0 / 0.05 / 0.1 / 0.15 / 0.2 / 0.25 / 0.3 / 0.35 / 0.4 / 0.45 / 0.5 / 0.6 / 0.7 / 0.8 / 0.9 / 1.0	14 73 60	14 78 60
Sodiumhypochlorite	2 - 18 %	2 / 3 / 4 / 5 / 6 / 7 / 8 / 9 / 10 / 11 / 12 / 13 / 14 / 15 / 16 / 18	14 74 90	14 79 90
Sulfite LR	0.5 - 10 mg/l SO ₃ ²⁻	0.5 / 1 / 1.5 / 2 / 2.5 / 3 / 3.5 / 4 / 4.5 / 5 / 6 / 7 / 8 / 9 / 10	14 73 80	14 78 80
Total Alkalinity	20 - 240 mg/l CaCO ₃	20 / 30 / 40 / 50 / 60 / 70 / 80 / 90 / 100 / 110 / 120 / 130 / 140 / 150 / 160 / 170 / 180 / 190 / 200 / 220 / 240	14 74 50	14 79 50
Zinc LR	0 - 1 mg/l Zn	0 / 0.1 / 0.2 / 0.3 / 0.4 / 0.5 / 0.6 / 0.7 / 0.8 / 0.9 / 1.0	14 73 40	14 78 40

* RAPID: fast dissolving tablet
including stirring rod

Disc	Reagents	Quantity	Code
14 63 50	SILICA No. 1	100	51 31 30 BT
		250	51 31 31 BT
	SILICA No. 2	100	51 31 40 BT
		250	51 31 41 BT
	Combi pack [#]	each 100	51 76 71 BT
	SILICA No.1 / No.2	each 200	51 76 72 BT
14 63 51	SILICA PR	100	51 31 50 BT
		250	51 31 51 BT
	Vario Silica HR Molybdate F10	Powder Pack / 100	53 57 00
	Vario Silica HR Acid Rgt F10	Powder Pack / 100	
Vario Silica HR Citric Acid F10	Powder Pack / 100		
14 63 60	SILICA No. 1	100	51 31 30 BT
		250	51 31 31 BT
	SILICA No. 2	100	51 31 40 BT
		250	51 31 41 BT
	Combi pack [#]	each 100	51 76 71 BT
	SILICA No.1 / No.2	each 200	51 76 72 BT
	SILICA PR	100	51 31 50 BT
		250	51 31 51 BT
14 64 90	CHLORINE HR (KI)	100	51 30 00 BT
		250	51 30 01 BT
	ACIDIFYING GP	100	51 54 80 BT
		250	51 54 81 BT
	Combi pack [#]	each 100	51 77 21 BT
	CHLORINE HR (Ki)/ACIDIFYING GP	each 250	51 77 22 BT
14 63 80	Dilution set for sample preparation	1	41 44 70
	SULFITE LR	100	51 80 20
14 64 50	ALKACHECK	100	51 32 00 BT
		250	51 32 01 BT
14 63 40	COPPER/ZINC LR	100	51 26 20 BT
		250	51 26 21 BT
	EDTA	100	51 23 90 BT
		250	51 23 91 BT
	DECHLOR	100	51 23 50 BT



CHECKIT®Discs

Material Safety Data Sheets: www.lovibond.com

[†] additionally required for determination of chlorine dioxide / ozone in the presence of chlorine

Comparator 2000+



Applications

- Water Treatment (e.g. Drinking Water)
- Pool-Water
- Research Centres
- Universities
- Special Applications
- Laboratory and Field Testing

The system for
colorimetric water analysis

Comparator 2000+

With its accessories, the Lovibond® Comparator system 2000+ is an extremely versatile, modular system for testing water. It is simple to use yet is uncompromising in terms of precision and reproducibility of results. It is compact and portable. The integrated prism brings the glass standards of the test discs and the coloured sample into the same field of view.

Test discs

The required accuracy of results is only ensured if stable, fade-free colour standards are used.

Glass colour standards are fade-free, resistant to chemicals and scratchproof. Lovibond® standards are made from coloured glass filters. They comply with international standards, e.g. ISO 7393/2.

Please see the table on page 30 for information on the various test discs or refer to our **L 213 test disc catalogue**.

Lighting unit

We recommend the use of the battery-operated Lovibond® lighting unit in variable lighting conditions. This guarantees uniform lighting conditions, and ensures greater test accuracy.

Cells

We manufacture precision plastic and optical glass cells in line with the highest quality standards. The cells ensure high precision and reproducibility of results.



Comparator 2000+



Test disc with colour-stable glass standards



Lighting unit TK 102



Nessleriser with lighting unit

➔ Order codes see page 29

Highlights

- More than 400 different test discs available
- Compensation for coloured and turbid samples
- Guaranteed constancy of the coloured glass standards
- Integrated prism

Comparator 2000+ Test Kits

Complete kits for water analysis

Scope of delivery for standard kits

Comparator test kits are supplied as a complete system in a sturdy plastic case. Together with the Comparator 2000+ and test discs, each kit includes all the necessary cells, accessories and Lovibond® tablet reagents (for 100 measurements) to achieve reliable results.

The table to the right shows a selection of the most popular standard test kits.

Customised equipment

In addition to supplying standard test kits, we can construct customised kits to suit individual requirements.

Based on the desired test parameters and measuring ranges we will draw up a detailed offer to suit your application.

Optional accessory

All test kit versions allow integration of the battery-operated portable lighting unit TK 102 and charger TK 102/ 1.

Operating instructions

The operating instructions provide a step-by-step explanation of how to conduct the water test, ensuring that even "non-chemists" can achieve reliable and accurate measurements in the minimum of time.



Example of a comparator test kit, together with daylight unit

Type	Designation/Combi	Test	Range*	Code
AF 270	Mini Lab Pool Water	Aluminium	0 - 0.5 mg/l Al	41 27 00
		Ammonia	0 - 0.4 mg/l N	
		Chlorine	0.1 - 1.0 mg/l Cl ₂ 1.0 - 4.0 mg/l Cl ₂ 5 - 5000 mg/l Cl ⁻	
AF 357	Drinking Water	Chloride Stabilizer	0 - 80 mg/l	41 35 70
		Iron	0.1 - 1.0 mg/l Fe	
		pH-value	5.2 - 6.8 pH 6.8 - 8.4 pH	
AF 358	Sewage and Domestic Effluents	Alkalinity-M Sulphate	20 - 800 mg/l CaCO ₃ 40 - 4000 mg/l SO ₄	41 35 80
		Chloride (salinity) Chlorine	0 - 5000 mg/l Cl 0.02 - 0.3 mg/l Cl ₂ 0.2 - 4 mg/l Cl ₂	
		Hardness Total Fluoride Hazen Colour pH-value	0 - 500 mg/l CaCO ₃ 0 - 1.6 mg/l F 10 - 90 mg/l Pt 6 - 8.4 pH	
AF 368	Mini Lab Heavy Metals (supplied without reagents)	Ammonia	0 - 1 mg/l N	41 36 80
		Chlorine	0.1 - 1 mg/l Cl ₂ 1 - 10 mg/l Cl ₂	
		Nitrite Permanganate (BOD) pH-value Sulphide	0.05 - 0.5 mg/l N 0 - 60 mg/l 4 - 8 ; 8 - 9.6 pH 0 - 0.5 mg/l S	
Chromium	10 - 100 µg Cr	41 36 80		
Copper	2.5 - 50 µg Cu			
Cyanide	0.05 - 1 mg/l Cn			
Nickel	1 - 10 mg/l Ni	41 36 80		
Zinc	0 - 50 µg Zn			
Type	Designation/Single	Test	Range*	Code
AF 274	Amine	Amine	1 - 10 mg/l	41 27 40
AF 112A	Chlorine free, comb. tot.	Chlorine	0.1 - 1 mg/l Cl ₂	41 11 20
AF 112B	Chlorine free, comb. tot.	Chlorine	0.2 - 4 mg/l Cl ₂	41 11 30
AF 112E	Chlorine free, comb. tot.	Chlorine	0.02 - 0.3 mg/l Cl ₂	41 12 50
AF 112E/F	Chlorine free, comb. tot.	Chlorine Chlorine	0.02 - 0.3 mg/l Cl ₂ 0.2 - 0.8 mg/l Cl ₂	41 11 26
AF 112J/J	Chlorine free, comb. tot.	Chlorine pH-value	0.1 - 2.0 mg/l Cl ₂ 6.8 - 8.4 pH	41 72 46
AF 112N/T	Chlorine free, comb. tot.	Chlorine Chlorine	0.1 - 1.0 mg/l Cl ₂ 1.1 - 2.0 mg/l Cl ₂	41 01 20
AF 112ED	Chlorine dioxide	Chlorine dioxide	0.04 - 0.57 mg/l ClO ₂	41 00 01
AF 112 EF/ED	Chlorine dioxide	Chlorine dioxide	0.04 - 1.52 mg/l ClO ₂	41 00 07
AF 116A	Chlorine, pH	Chlorine pH-value	0.1 - 1 mg/l Cl ₂ 6.8 - 8.4 pH	41 11 40
AF 116B	Chlorine, pH	Chlorine pH-value	0.2 - 4 mg/l Cl ₂ 6.8 - 8.4 pH	41 11 60
AF 118S	Chlorine, pH	Chlorine pH-value	0.1 - 4 mg/l Cl ₂ 5.2 - 8.4 pH	41 11 81
AF 139	Sodium hypochlorite	Sodium hypochlorite	2 - 18 % NaOCl	41 13 90
AF 129	Water Balance			41 12 90

* Disc readings see following pages

Comparator 2000+ and Accessories

Type	Item	Code
TK 100	Lovibond® Comparator 2000+	14 20 00
TK 102	Portable lighting unit, battery operated	14 20 50
	Daylight Unit for Comparator 2000+, mains operated	17 10 10
AF 631	Water sampler with two 500 ml bottles and one lid	17 05 00
	Measuring beaker, 100 ml	38 48 01
	Vial stand for 10 vials (ø 16 mm or □ 13,5 mm), acrylic glass	41 89 57
	Glass stirring rod, 12 cm length	36 41 10
	Plastic stirring rod, 13 cm length	36 41 00
	Brush, 11 cm length	38 02 30

Glass Cells

Type	Item	Code
DB424/S	5 glass cells, 13.5 mm path length, calibrated at 2 – 12 ml, with lids	35 42 43
W680/40	Glass cell 40 mm path length, calibrated at 20 ml	60 68 90

Plastic Cells

	5 plastic cells, frosted on two sides, 13.5 mm path length, volume 10 ml, with lid	14 55 05
	10 plastic cells, as 14 55 05	14 55 00
	100 plastic cells, as 14 55 05	14 55 10

Nessleriser System and Accessories

Type	Item	Code
2150	Nessleriser 2150 with stand, daylight unit and AF 306/P	17 20 30
2150	Nessleriser 2150 with stand	17 21 50
2150	Nessleriser 2150 upgrade kit	17 21 60
2250	Nessleriser 2250 with stand, daylight unit and DB 420	17 20 40
2250	Nessleriser 2250 with stand	17 22 50
2250	Nessleriser 2250 upgrade kit with Nessler tubes DB 420	17 21 70
	Daylight Unit for Nessleriser, mains operated	17 10 20
	Stand for Nessleriser upgrade kit	17 21 80
AF 306/S	Stand for 12 Nessler tubes	17 02 90
AF 306	Pair Nessler tubes, 113 mm	35 30 60
AF 306/P	Pair Nessler tubes, 113 mm with plungers	35 30 80
	Plunger for Nessler tube AF 306 and AF 306/P	35 30 70
DB 420	Pair Nessler tubes, 250 mm with plungers	35 42 00
	Plunger for Nessler tube DB 420	35 42 29
AF 315	Special Nessler tube (determination of oxygen with disc NOE)	35 31 50



Glass cell with lid, volume 10 ml,
calibrated 2 - 12 ml, path length 13,5 mm,
Pack of 5, code: 35 42 43

Comparator 2000+

Tests, Discs, Reagents, Cells

Test	Disc	Disc Readings	Range	Code
Aluminium	3/127 A	0; 0.05; 0.1; 0.15; 0.2; 0.25; 0.3; 0.4; 0.5 mg/l	0 - 0.5 mg/l	23 02 05
Amine	3/58	1; 2; 3; 4; 5; 6; 7; 8; 10 mg/l	1.0 - 10 mg/l	23 58 00
Amine	3/64	0; 0.25; 0.5; 1; 2 mg/l	0 - 2 mg/l	23 64 00
Ammonia	3/112	0; 0.05; 0.1; 0.15; 0.2; 0.25; 0.3; 0.35; 0.4 mg/l	0 - 0.4 mg/l NH ₄	23 00 60
Ammonia	3/113	0; 0.1; 0.2; 0.3; 0.4; 0.5; 0.6; 0.8; 1 mg/l	0 - 1.0 mg/l N	23 00 70
Ammonia	3/125	0; 1; 2; 3; 4; 5; 6; 8; 10 mg/l	0 - 10 mg/l N	23 01 80
Ammonia	NAA	1; 2; 3; 4; 5; 6; 8; 10 µg	1 - 10 µg NH ₃	28 31 10
Ammonia	NAB	10; 12; 14; 16; 18; 20; 22; 24; 26 µg	10 - 26 µg NH ₃	28 31 20
Ammonia	NAC	28; 32; 36; 40; 44; 48; 52; 56; 60 µg	28 - 60 µg NH ₃	28 31 30
Ammonia	NAD	60; 65; 70; 75; 80; 85; 90; 95; 100 µg	60 - 100 µg NH ₃	28 31 40

including stirring rod

Reagents	Quantity	Code	Accessories	Code
ALUMINIUM No.1	100	51 54 60 BT	13.5 mm cell, 10 ml	35 42 43
	250	51 54 61 BT		
ALUMINIUM No.2	100	51 54 70 BT		
	250	51 54 71 BT		
Combi pack#	each 100	51 76 01 BT		
ALUMINIUM No.1 / No.2	each 250	51 76 02 BT		
AMINE	100	51 10 10	Extraction tube AF260	35 26 00
	250	51 10 11		
Details on request			13.5 mm cell, 10 ml	35 42 43
AMMONIA No.1	100	51 25 80 BT	40 mm cell W680/40	60 68 90
	250	51 25 81 BT		
AMMONIA No.2	100	51 25 90 BT		
	250	51 25 91 BT		
Combi pack#	each 100	51 76 11 BT		
AMMONIA No.1 / No.2	each 250	51 76 12 BT		
AMMONIA No.1/2			13.5 mm cell, 10 ml	35 42 43
AMMONIA No.1/2			5 mm cell W680	60 67 90
NESSLER reagent	30 ml	46 52 00	Nessler tubes 113 mm	35 30 60
	100 ml	46 52 01		
SEIGNETTE salt solution	100 ml	46 61 01		
NESSLER reagent SEIGNETTE salt solution			Nessler tubes 113 mm	35 30 60
NESSLER reagent SEIGNETTE salt solution			Nessler tubes 113 mm	35 30 60
NESSLER reagent SEIGNETTE salt solution			Nessler tubes 113 mm	35 30 60



Lighting unit, mains operated

Material Safety Data Sheets: www.lovibond.com

Comparator 2000+

Tests, Discs, Reagents, Cells

Test	Disc	Disc Readings	Range	Code
Bromine	3/53A	0.2; 0.4 ; 0.6; 0.8; 1; 1.2; 1.4; 1.6; 2 mg/l	0.2 - 2.0 mg/l	23 53 10
Bromine	3/53B	1; 2; 3; 4; 5; 6; 7; 8; 10 mg/l	1.0 - 10 mg/l	23 53 20
Bromine	3/53C	0.5; 1; 1.5; 2; 2.5; 3; 4; 5; 6 mg/l	0.5 - 6 mg/l	23 53 30
Chlorine free, combined, total	3/40E	0.02; 0.04 ; 0.06; 0.08; 0.1; 0.15; 0.2; 0.25; 0.3 mg/l	0.02 - 0.3 mg/l	23 40 60
Chlorine free, combined, total		0.02; 0.04 ; 0.06; 0.08; 0.1; 0.2; 0.3; 0.4; 0.5 mg/l	0.02 - 0.5 mg/l	29 59 20
Chlorine free, combined, total	3/40F	0.2; 0.25 ; 0.3; 0.35; 0.4; 0.5; 0.6; 0.7; 0.8 mg/l	0.2 - 0.8 mg/l	23 40 70
Chlorine free, combined, total	3/40G	1.5; 1.8; 2.0; 2.3; 2.5; 2.7; 3.0; 3.2; 3.5 mg/l	1.5 - 3.5 mg/l	23 40 30
Chlorine free, combined, total	3/40A	0.1; 0.2; 0.3; 0.4; 0.5; 0.6; 0.7; 0.8; 1 mg/l	0.1 - 1.0 mg/l	23 40 10
Chlorine free, combined, total	3/40T	0.1; 0.2; 0.3; 0.4; 0.5; 0.6; 0.7; 0.8; 1 mg/l	0.1 - 1.0 mg/l	23 41 10
Chlorine free, combined, total	3/40N	1.1; 1.2; 1.3; 1.4; 1.5; 1.6; 1.7; 1.8; 2 mg/l	1.1 - 2.0 mg/l	23 39 60
Chlorine free, combined, total	3/40J	0.1; 0.2; 0.3; 0.4; 0.6; 0.8; 1; 1.5; 2 mg/l	0.1 - 2.0 mg/l	23 41 40

including stirring rod

Reagents	Quantity	Code	Accessories	Code
DPD No.1	100	51 10 50 BT	13.5 mm cell, 10 ml	35 42 43
	250	51 10 51 BT		
	500	51 10 52 BT		
DPD No.1			13.5 mm cell, 10 ml	35 42 43
DPD No.1			13.5 mm cell, 10 ml	35 42 43
DPD No.1	100	51 10 50 BT	40 mm cell W680/40	60 68 90
	250	51 10 51 BT		
	500	51 10 52 BT		
DPD No.2	100	51 15 30 BT		
	250	51 15 31 BT		
DPD No.3	100	51 10 80 BT		
	250	51 10 81 BT		
	500	51 10 82 BT		
Combi pack [#]	each 100	51 77 11 BT		
DPD No.1 / No.3	each 250	51 77 12 BT		
DPD No.4	100	51 12 20 BT		
	250	51 12 21 BT		
	500	51 12 22 BT		
DPD No.1/2/3/4			40 mm cell W680/40	60 68 90
DPD No.1/2/3/4			40 mm cell W680/40	60 68 90
DPD No.1/2/3/4			13.5 mm cell, 10 ml	35 42 43
DPD No.1/2/3/4			13.5 mm cell, 10 ml	35 42 43
DPD No.1/2/3/4			25 mm cell W680/25	60 68 60
			13.5 mm cell, 10 ml	35 42 43
DPD No.1/2/3/4			25 mm cell W680/25	60 68 60
			13.5 mm cell, 10 ml	35 42 43
DPD No.1/2/3/4			13.5 mm cell, 10 ml	35 42 43



Tablet reagents in foil blister strip (BT)

 Material Safety Data Sheets: www.lovibond.com

Comparator 2000+

Tests, Discs, Reagents, Cells

Test	Disc	Disc Readings	Range	Code
Chlorine free, combined, total	3/40B	0.2; 0.4; 0.6; 1; 1.5; 2; 2.5; 3; 4 mg/l	0.2 - 4.0 mg/l	23 40 20
Chlorine free, combined, total	3/40K	0.5; 1; 1.5; 2; 2.5; 3; 4; 5; 6 mg/l	0.5 - 6.0 mg/l	23 39 30
Chlorine free, combined, total	3/40S	1; 1.2; 1.4; 1.6; 1.8; 2; 2.5; 3; 4 mg/l	1.0 - 4.0 mg/l	23 40 90
Chlorine free, combined, total	3/40P	2; 2.3; 2.5; 2.7; 3; 3.2; 3.6; 4; 5 mg/l	2.0 - 5.0 mg/l	23 39 20
Chlorine free, combined, total	3/40HN	2; 3; 4; 5; 6; 7; 8; 9; 10 mg/l	2.0 - 10 mg/l	23 40 81
Chlorine / pH free, combined, total	3/40CZ	0.5; 1; 1.5; 2; 4 mg/l Cl ₂ 7; 7.4; 7.6; 8 pH	0.5 - 4 mg/l Cl ₂ 7 - 8 pH	23 39 90
Chlorine free, combined, total	3/2A	0.1; 0.2; 0.3; 0.4; 0.5; 0.6; 0.7; 0.8; 1 mg/l	0.1 - 1.0 mg/l	23 20 10
Chlorine free, combined, total	3/2AB	0.15; 0.25; 0.5; 0.75; 1; 1.25; 1.5; 1.75; 2 mg/l	0.15 - 2.0 mg/l	23 20 20
Chlorine free, combined, total	3/2APC	1; 1.5; 2; 2.5; 3; 3.5; 4; 4.5; 5 mg/l	1.0 - 5.0 mg/l	23 20 50
Chlorine HR total chlorine only	3/2APH	2; 3; 4; 5; 6; 7; 8; 9; 10 mg/l total Cl ₂	2 - 10 mg/l	23 20 60
Chlorine HR total chlorine only	3/2ARP	5; 10; 15; 20; 25; 30; 35; 40; 50 mg/l total Cl ₂	5.0 - 50 mg/l	23 20 70
Chlorine HR total chlorine only	3/2IOD	5; 10; 25; 50; 75; 100; 150; 200; 250 mg/l total Cl ₂	5.0 - 250 mg/l	23 20 90

including stirring rod

Reagents	Quantity	Code	Accessories	Code
DPD No.1/2/3/4			13.5 mm cell, 10 ml	35 42 43
DPD No.1/2/3/4			13.5 mm cell, 10 ml	35 42 43
DPD No.1/2/3/4			13.5 mm cell, 10 ml	35 42 43
DPD No.1/2/3/4			13.5 mm cell, 10 ml	35 42 43
DPD No.1/2/3/4			5 mm cell W680/5	60 67 90
DPD No.1/2/3/4 Phenol red tablets, see pH determination			13.5 mm cell, 10 ml	35 42 43
			13.5 mm cell, 10 ml	35 42 43
Reagents at specialized chemistry dealer			13.5 mm cell, 10 ml	35 42 43
Reagents at specialized chemistry dealer			13.5 mm cell, 10 ml	35 42 43
Reagents at specialized chemistry dealer			5 mm cell W680/5	60 67 90
CHLORINE HR (KI)	100	51 30 00 BT	40 mm cell W680/40	60 68 90
	250	51 30 01 BT		
ACIDIFYING GP	100	51 54 80 BT		
	250	51 54 81 BT		
Combi pack#	each 100	51 77 21 BT		
CHLORINE HR (KI)/ ACIDIFYING GP	each 250	51 77 22 BT		
CHLORINE HR (KI) ACIDIFYING GP			13.5 mm cell, 10 ml	35 42 43
CHLORINE HR (KI) ACIDIFYING GP			13.5 mm cell, 10 ml	35 42 43



Test disc

Material Safety Data Sheets: www.lovibond.com

Comparator 2000+

Tests, Discs, Reagents, Cells

Test	Disc	Disc Readings	Range	Code
Chlorine free, combined, total	NDPB	0.01; 0.02; 0.03; 0.04; 0.05; 0.06; 0.07; 0.08; 0.1 mg/l	0.01 - 0.1 mg/l	28 34 50
Chlorine free, combined, total	NDPC	0.02; 0.04; 0.06; 0.08; 0.1; 0.12; 0.14; 0.16; 0.2 mg/l	0.02 - 0.2 mg/l	28 34 60
Chlorine free, combined, total	NDP	0.05; 0.1; 0.15; 0.2; 0.25; 0.3; 0.35; 0.4; 0.5 mg/l	0.05 - 0.5 mg/l	28 34 40
Chlorine free, combined, total	NDPD	0.1; 0.2; 0.3; 0.4; 0.5; 0.6; 0.7; 0.8; 1 mg/l	0.1 - 1.0 mg/l	28 34 70
Chlorine dioxide	3/40AD	0.19; 0.38; 0.57; 0.76; 0.95; 1.14; 1.33; 1.52; 1.9 mg/l	0.19 - 1.9 mg/l	29 22 60
Chlorine dioxide	3/40ED	0.04; 0.08; 0.11; 0.15; 0.19; 0.28; 0.38; 0.48; 0.57 mg/l	0.04 - 0.57 mg/l	29 79 70
Chlorine dioxide	3/40FD	0.38; 0.48; 0.57; 0.66; 0.76; 0.95; 1.14; 1.33; 1.52 mg/l	0.38 - 1.52 mg/l	29 87 50
Chlorine dioxide	3/157	0.25; 0.5; 0.75; 1; 1.25; 1.5; 2; 3; 5 mg/l	0.25 - 5.0 mg/l	23 05 70
Chromium	3/59	10; 20; 30; 40; 50; 60; 70; 80; 100 µg	10 - 100 µg	23 59 00
Copper	3/106	0; 0.1; 0.2; 0.3; 0.4; 0.5; 0.6; 0.8; 1 mg/l	0 - 1.0 mg/l	23 00 50
Copper	3/110	0; 0.5; 1; 1.5; 2; 2.5; 3; 3.5; 4 mg/l	0 - 4.0 mg/l	23 00 40

including stirring rod

Reagents	Quantity	Code	Accessories	Code
DPD No.1 NESSLERISER	100	51 12 30 BT	Nessleriser 2150	17 21 50
	250	51 12 31 BT	Nessler tubes 113 mm	35 30 60
DPD No.2 NESSLERISER	100	51 12 40		
	250	51 12 41		
DPD No.3 NESSLERISER	100	51 12 50 BT		
	250	51 12 51 BT		
DPD No.4 NESSLERISER	100	51 12 60 BT		
	250	51 12 61 BT		
<hr/>				
DPD No.1/2/3/4 NESSLERISER			Nessleriser 2150	17 21 50
			Nessler tubes 113 mm	35 30 60
<hr/>				
DPD No.1/2/3/4 NESSLERISER			Nessleriser 2150	17 21 50
			Nessler tubes 113 mm	35 30 60
<hr/>				
DPD No.1/2/3/4 NESSLERISER			Nessleriser 2150	17 21 50
			Nessler tubes 113 mm	35 30 60
<hr/>				
DPD No.1	100	51 10 50 BT	13.5 mm cell, 10 ml	35 42 43
	250	51 10 51 BT		
<hr/>				
DPD No.1			40 mm cell W680/40	60 68 90
<hr/>				
DPD No.1			40 mm cell W680/40	60 68 90
<hr/>				
CHLORINE HR (KI)	100	51 30 00 BT	40 mm cell W680/40	60 68 90
	250	51 30 01 BT		
ACIDIFYING GP	100	51 54 80 BT		
	250	51 54 81 BT		
Combi pack [#]	each 100	51 77 21 BT		
CHLORINE HR (KI)/	each 250	51 77 22 BT		
ACIDIFYING GP				
<hr/>				
Details on request			13.5 mm cell, 10 ml	35 42 43
<hr/>				
COPPER/ZINC LR	100	51 26 20 BT	13.5 mm cell, 10 ml	35 42 43
	250	51 26 21 BT		
<hr/>				
COPPER/ZINC HR	100	51 23 40 BT	13.5 mm cell, 10 ml	35 42 43
	250	51 23 41 BT		

Material Safety Data Sheets: www.lovibond.com



Lighting unit with comparator and discs, mains operated

Comparator 2000+

Tests, Discs, Reagents, Cells

Test	Disc	Disc Readings	Range	Code
DEHA	3/150	8; 16; 24; 32; 40; 48; 56; 64; 80 µg/l Disc reading should be multiplied by 2 for true DEHA concentration	16 - 160 µg/l	23 04 60
Fluoride	NOM	0; 0.2; 0.4; 0.6; 0.8; 1; 1.2; 1.4; 1.6 mg/l	0 - 1.6 mg/l	28 37 30
Hardness, total	4/38	0; 5; 10; 15; 20; 25; 30; 40; 60 mg/l	0 - 60 mg/l CaCO ₃	23 10 70
Hazen/APHA	4/28	50; 75; 100; 150; 200; 250; 300; 400; 500 mg Pt/l	50 - 500 mg/l Pt	24 28 01
Hazen/APHA	NSH	10; 20; 30; 40; 50; 60; 70; 80; 90 mg Pt/l	10 - 90 mg/l Pt	28 41 70
Hazen/APHA	NSB	70; 85; 100; 125; 150; 175; 200; 225; 250 mg Pt/l	70 - 250 mg/l Pt	28 41 20
Hazen/APHA	CAA	0; 2.5; 5; 7.5; 10; 15; 20; 25; 30 mg Pt/l	0 - 30 mg/l Pt	28 41 50
Hazen/APHA	CAB	30; 35; 40; 45; 50; 55; 60; 65; 70 mg Pt/l	30 - 70 mg/l Pt	28 41 60
Hydrazine	3/126	0; 0.05; 0.1; 0.15; 0.2; 0.25; 0.3; 0.4; 0.5 mg/l	0 - 0.5 mg/l	23 01 90
Hydrazine	3/135	0.02; 0.04; 0.06; 0.08; 0.1; 0.12; 0.14; 0.16; 0.2 mg/l	0.02 - 0.2 mg/l	23 02 90
Hydrazine	3/85	0; 0.1; 0.2; 0.3; 0.4; 0.5; 0.6; 0.8; 1 mg/l	0 - 1.0 mg/l	23 85 00
Hydrazine	NOH	0; 0.5; 1; 2; 3; 4; 6; 8; 10 µg	0 - 10 µg/l	28 37 00
Hydrogen peroxide	3/50 A	0.05; 0.1; 0.15; 0.2; 0.25; 0.3; 0.35; 0.4; 0.5 mg/l	0.05 - 0.5 mg/l	23 50 00
Hydrogen peroxide	3/50 B	0.1; 0.2; 0.3; 0.4; 0.6; 1; 1.5; 2; 3 mg/l	0.1 - 3 mg/l	23 50 10

including stirring rod

Reagents	Quantity	Code	Accessories	Code
DEHA	100	51 32 20 BT	40 mm cell W680/40	60 68 90
	250	51 32 21 BT		
DEHA solution	100 ml	46 11 81		
FLUORIDE A-Z	100	51 14 00	Nessleriser 2150	17 21 50
	250	51 14 01	Nessler tubes 113 mm	35 30 60
FLUORIDE EXCESS AL	100	51 14 10		
	250	51 14 11		
ERIOCHROME HARDNESS powder	100 Tests	46 29 50	13.5 mm cell, 10 ml	35 42 43
Straight colour match to sample			40 mm cell W680/40	60 68 90
Straight colour match to sample			Nessleriser 2150	17 21 50
			Nessler tubes 113 mm	35 30 60
Straight colour match to sample			Nessleriser 2150	17 21 50
			Nessler tubes 113 mm	35 30 60
Straight colour match to sample			Nessleriser 2250	17 22 50
			Nessler tubes 250 mm	35 42 00
Straight colour match to sample			Nessleriser 2250	17 22 50
			Nessler tubes 250 mm	35 42 00
HYDRAZINE TEST powder	30 g	46 29 10	13.5 mm cell, 10 ml	35 42 43
HYDRAZINE TEST powder	30 g	46 29 10	40 mm cell W680/40	60 68 90
p-DMAB reagent	100 ml	46 12 61	13.5 mm cell, 10 ml	35 42 43
p-DMAB reagent	100 ml	46 12 61	Nessler tubes 113 mm	35 30 60
HYDR. PEROXIDE LR	100	51 23 80 BT	13.5 mm cell, 10 ml	35 42 43
	250	51 23 81 BT		
HYDR. PEROXIDE LR			13.5 mm cell, 10 ml	35 42 43

Material Safety Data Sheets: www.lovibond.com



Lighting unit TK 102, battery operated

Comparator 2000+

Tests, Discs, Reagents, Cells

Test	Disc	Disc Readings	Range	Code
Hydrogen peroxide	3/50 E	0.01; 0.02; 0.03; 0.04; 0.05; 0.07; 0.09; 0.12; 0.15 mg/l	0.01 - 0.15 mg/l	23 50 20
Iodine	3/77A	0.4; 0.7; 1.1; 1.4; 1.8; 2.2; 2.5; 2.9; 3.6 mg/l	0.4 - 3.6 mg/l	23 77 10
Iodine	3/77B	0.7; 1.4; 2.2; 3.6; 5.4; 7.2; 9.0; 11; 14 mg/l	0.7 - 14 mg/l	23 77 20
Iron, total	3/144	0.02; 0.04; 0.06; 0.08; 0.1; 0.15; 0.2; 0.25; 0.3 mg/l	0.02 - 0.3 mg/l	23 03 80
Iron, total	3/116	0.1; 0.2; 0.3; 0.4; 0.5; 0.6; 0.7; 0.8; 1 mg/l	0.1 - 1.0 mg/l	23 01 00
Iron, total	3/117	1; 2; 3; 4; 5; 6; 7; 8; 10 mg/l	1.0 - 10 mg/l	23 01 10
Iron, total	NOL	0.01; 0.02; 0.03; 0.04; 0.05; 0.06; 0.07; 0.08; 0.10 mg/l	0.01 - 0.1 mg/l	28 37 20
Manganese	3/169	0; 0.5; 1; 1.5; 2; 2.5; 3; 3.5; 4 mg/l	0 - 4.0 mg/l	23 06 90
Molybdate	3/162	0; 1; 2; 3; 4; 5; 6; 8; 10 mg/l	0 -10 mg/l MoO ₄	23 06 20
Molybdate	3/137	5; 10; 15; 20; 25; 30; 35; 40; 50 mg/l	5.0 -50 mg/l MoO ₄	23 03 20
Molybdate	3/138	10; 20; 30; 40; 60; 80; 100; 120; 150 mg/l	10 -150 mg/l MoO ₄	23 03 30

including stirring rod

Reagents	Quantity	Code	Accessories	Code
HYDR. PEROXIDE LR			40 mm cell W680/40	60 68 90
DPD No.1	100 250	51 10 50 BT 51 10 51 BT	13.5 mm cell, 10 ml	35 42 43
DPD No.1			13.5 mm cell, 10 ml	35 42 43
IRON LR (Fe ²⁺ and Fe ³⁺)	100 250	51 53 70 BT 51 53 71 BT	40 mm cell W680/40	60 68 90
IRON LR (Fe ²⁺ and Fe ³⁺)	100 250	51 53 70 BT 51 53 71 BT	13.5 mm cell, 10 ml	35 42 43
IRON (II) LR (Fe ²⁺)	100	51 54 20 BT		
IRON HR	100 250	51 53 80 BT 51 53 81 BT	13.5 mm cell, 10 ml	35 42 43
IRON LR + IRON (II) LR			Nessleriser 2150 Nessler tubes 113 mm	17 21 50 35 30 60
MANGANESE LR 1	100 250	51 60 80 BT 51 60 81 BT	13.5 mm cell, 10 ml	35 42 43
MANGANESE LR 2	100 250	51 60 90 BT 51 60 91 BT		
Combi pack [#] MANGANESE LR 1/ MANGANESE LR 2	each 100 each 250	51 76 21 BT 51 76 22 BT		
Details on request			40 mm cell W680/40	60 68 90
MOLYBDATE No.1 HR	100 250	51 30 60 BT 51 30 61 BT	40 mm cell W680/40	60 68 90
MOLYBDATE No.2 HR	100 250	51 30 70 BT 51 30 71 BT		
Combi pack [#] MOLYBDATE No.1 HR / MOLYBDATE No.2 HR	each 100 each 250	51 76 31 BT 51 76 32 BT		
MOLYBDATE No.1 HR MOLYBDATE No.2 HR			13.5 mm cell, 10 ml	35 42 43



Tablet reagents in blister (BT)

 Material Safety Data Sheets: www.lovibond.com

Comparator 2000+

Tests, Discs, Reagents, Cells

Test	Disc	Disc Readings	Range	Code
Nitrate	3/124	0.1; 0.2; 0.3; 0.4; 0.5; 0.6; 0.7; 0.8; 1 mg/l	0.1 - 1.0 mg/l N	23 01 70
Nitrate	3/142	10; 20; 30; 40; 50; 60; 70; 80; 100 mg/l	10 - 100 mg/l N	23 03 60
Nitrite	3/103	0.05; 0.1; 0.15; 0.2; 0.25; 0.3; 0.35; 0.4; 0.5 mg/l	0.05 - 0.5 mg/l N	23 00 30
Nitrite	NJP	0.002; 0.004; 0.006; 0.01; 0.015; 0.02; 0.03; 0.04; 0.05 mg/l	0.002 - 0.05 mg/l N	28 39 60
Nitrite	NJ	0.05; 0.1; 0.2; 0.3; 0.4; 0.5; 0.6; 0.8; 1 µg/l	0.05 - 1.0 µg/l N	28 35 80
Oxygen	3/165	2; 3; 4; 5; 6; 7; 8; 10; 12 mg/l	2.0 - 12 mg/l	23 06 50
Ozone	3/67	0.1; 0.2; 0.3; 0.4; 0.5; 0.6; 0.7; 0.8; 1 mg/l	0.1 - 1.0 mg/l	23 67 00
Ozone	3/67A	0.01; 0.02; 0.03; 0.04; 0.05; 0.06; 0.07; 0.08; 0.1 mg/l	0.01 - 0.1 mg/l	23 67 10
Ozone	3/67S	0.05; 0.1; 0.15; 0.2; 0.25; 0.3; 0.35; 0.4; 0.45 mg/l	0.05 - 0.45 mg/l	23 67 70
Ozone	3/148	0; 0.05; 0.1; 0.15; 0.2; 0.25; 0.3; 0.4; 0.5 mg/l	0 - 0.5 mg/l	23 04 40

including stirring rod

Reagents	Quantity	Code	Accessories	Code
NITRATE-TEST tablets	100 (bottle)	50 28 10	13.5 mm cell, 10 ml	35 42 43
NITRATE TEST powder	15 g	46 52 30	Nitrate-Test tubes	36 62 20
NITRITE LR	100	51 23 10BT		
	250	51 23 11BT		
NITRATE No.1	100	51 31 10	13.5 mm cell, 10 ml	35 42 43
NITRATE No.2	100	51 31 20		
	250	51 31 21		
Combi pack#	each 100	51 76 41		
Nitrate No.1 / No.2	each 250	51 76 42		
NITRITE LR	100	51 23 10BT	13.5 mm cell, 10 ml	35 42 43
	250	51 23 11BT		
NITRITE LR	100	51 23 10BT	Nessler tubes 113 mm	35 30 60
	250	51 23 11BT		
NITRITE ACIDIFYING	250 (bottle)	50 23 71		
Details on request			Nessler tubes 113 mm	35 30 60
DO reagent No.1	100 Tests	46 11 50	13.5 mm cell, 10 ml	35 42 43
DO reagent No.2	100 Tests	46 11 60		
DO reagent No.3	90 Tests	46 11 70		
DPD No.4	100	51 12 20 BT	13.5 mm cell, 10 ml	35 42 43
	250	51 12 21 BT		
DPD No.4	100	51 12 20 BT	40 mm cell W680/40	60 68 90
	250	51 12 21 BT		
DPD No.4	100	51 12 20 BT	13.5 mm cell, 10 ml	35 42 43
	250	51 12 21 BT		
OZONE-INDIGO	100	51 31 70 BT	40 mm cell W680/40	60 68 90
	250	51 31 71 BT		



Tablet reagents in blister (BT)

Material Safety Data Sheets: www.lovibond.com

Comparator 2000+

Tests, Discs, Reagents, Cells

Test	Disc	Disc Readings	Range	Code
pH	2/1A	1.2; 1.4; 1.6; 1.8; 2.0; 2.2; 2.4; 2.6; 2.8	1.2 - 2.8 pH	22 10 10
pH	2/1B	2.8; 3; 3.2; 3.4; 3.6; 3.8; 4; 4.2; 4.4	2.8 - 4.4 pH	22 10 30
pH	2/1C	3.6; 3.8; 4; 4.2; 4.4; 4.6; 4.8; 5; 5.2	3.6 - 5.2 pH	22 10 50
pH	2/1E	4.4; 4.6; 4.8; 5; 5.2; 5.4; 5.6; 5.8; 6	4.4 - 6.0 pH	22 10 80
pH	2/1G	5.2; 5.4; 5.6; 5.8; 6; 6.2; 6.4; 6.6; 6.8	5.2 - 6.8 pH	22 11 00
pH	2/1H	6; 6.2; 6.4; 6.6; 6.8; 7; 7.2; 7.4; 7.6	6.0 - 7.6 pH	22 11 10
pH	2/1J	6.8; 7; 7.2; 7.4; 7.6; 7.8; 8; 8.2; 8.4	6.8 - 8.4 pH	22 11 30
pH	2/1K	7.2; 7.4; 7.6; 7.8; 8; 8.2; 8.4; 8.6; 8.8	7.2 - 8.8 pH	22 11 40
pH	2/1L	8; 8.2; 8.4; 8.6; 8.8; 9; 9.2; 9.4; 9.6	8.0 - 9.6 pH	22 11 90
pH	2/1P	4; 5; 6; 7; 8; 9; 9.4; 10; 11	4.0 - 11 pH	22 12 20
pH	2/1W	1.0; 1.2; 1.4; 1.6; 1.8; 2.0; 2.2; 2.4; 2.6	1.0 - 2.6 pH	22 12 50
pH	2/1Z	7.6; 7.8; 8; 8.2; 8.4; 8.6; 8.8; 9.0; 9.2	7.6 - 9.2 pH	22 12 70
pH	NLC	6; 6.2; 6.4; 6.6; 6.8; 7; 7.2; 7.4; 7.6	6.0 - 7.6 pH	28 10 30
pH	NLF	8; 8.2; 8.4; 8.6; 8.8; 9; 9.2; 9.4; 9.6	8.0 - 9.6 pH	28 10 60

including stirring rod

Reagents	Quantity	Code	Accessories	Code
THYMOL BLUE	100 250	51 16 50 51 16 51	13.5 mm cell, 10 ml	35 42 43
BROMOPHENOL BLUE	100 250	51 16 20 51 16 21	13.5 mm cell, 10 ml	35 42 43
BROMOCRESOL GREEN	100 250	51 17 60 51 17 61	13.5 mm cell, 10 ml	35 42 43
METHYL RED	100 ml	45 16 31	13.5 mm cell, 10 ml	35 42 43
BROMOCRESOL PURPLE	100 250	51 17 30 51 17 31	13.5 mm cell, 10 ml	35 42 43
BROMOTHYMOL BLUE	100 250	51 16 40 BT 51 16 41 BT	13.5 mm cell, 10 ml	35 42 43
PHENOL RED	100 250	51 17 50 BT 51 17 51 BT	13.5 mm cell, 10 ml	35 42 43
CRESOL RED	100 250	51 16 00 51 16 01	13.5 mm cell, 10 ml	35 42 43
THYMOL BLUE	100 250	51 16 50 51 16 51	13.5 mm cell, 10 ml	35 42 43
UNIVERSAL PH Indicator	25 ml 100 ml 250 ml	45 17 70 45 17 71 45 17 72	13.5 mm cell, 10 ml	35 42 43
M-CRESOL PURPLE	100 250	51 17 10 BT 51 17 11 BT	13.5 mm cell, 10 ml	35 42 43
M-CRESOL PURPLE	100 250	51 17 10 BT 51 17 11 BT	13.5 mm cell, 10 ml	35 42 43
BROMOTHYMOL BLUE PH Indicator	25 ml 100 ml 250 ml	45 16 20 45 16 21 45 16 22	Nessler tubes 113 mm	35 30 60
THYMOL BLAU PH Indicator	25 ml 100 ml 250 ml 500 ml	45 16 50 45 16 51 45 16 52 45 16 53	Nessler tubes 113 mm	35 30 60



Test disc

Material Safety Data Sheets: www.lovibond.com

Comparator 2000+

Tests, Discs, Reagents, Cells

Test	Disc	Disc Readings	Range	Code
Phosphate	3/133	0; 0.25; 0.5; 1; 1.5; 2; 2.5; 3; 4 mg/l	0 - 4.0 mg/l PO ₄	23 02 70
Phosphate	3/136	0; 5; 10; 15; 20; 25; 30; 35; 40 mg/l	0 - 40 mg/l PO ₄	23 03 10
Phosphate	3/12	0; 10; 20; 30; 40; 50; 60; 70; 80 mg/l	0 - 80 mg/l PO ₄	23 12 00
Phosphate	3/70	0; 10; 20; 30; 40; 50; 60; 70; 80; 100 mg/l	0 - 100 mg/l PO ₄	23 70 00
Phosphate	3/60	10; 20; 30; 40; 50; 60; 70; 80; 100 mg/l	10 - 100 mg/l PO ₄	23 60 00
Phosphate	NMD	10; 20; 30; 40; 50; 60; 70; 80; 100 µg/l	10 - 100 µg/l PO ₄	28 39 50
QAC (Quaternary Ammonia Compounds)	3/118	0; 2; 4; 6; 8; 10; 12; 15; 20 mg/l	0 - 20 mg/l	23 01 20
QAC (Quaternary Ammonia Compounds)	3/119	0; 20; 40; 60; 80; 100; 120; 150; 200 mg/l	0 - 200 mg/l	23 01 30
Silica	3/139	0.4; 0.6; 1; 1.5; 2; 2.5; 3; 3.5; 4 mg/l	0.4 - 4.0 mg/l SiO ₂	23 03 40
Silica	3/147	1; 2; 3; 4; 5; 6; 7; 8; 10 mg/l	1.0 - 10 mg/l SiO ₂	23 04 20
Silica	3/140	0.1; 0.2; 0.3; 0.4; 0.5; 0.6; 0.7; 0.8; 1.0 mg/l	0.1 - 1.0 mg/l SiO ₂	23 02 50
Silica	3/13	2.5; 5; 7.5; 10; 12.5; 15; 17.5; 20; 25 mg/l	2.5 - 25 mg/l SiO ₂	23 13 00
Silica	NN	1; 2; 4; 6; 8; 10; 12; 16; 20 mg/l	1.0 - 20 mg/l SiO ₂	28 36 30

including stirring rod

Reagents	Quantity	Code	Accessories	Code
PHOSPHATE No.1 LR	100	51 30 40	13.5 mm cell, 10 ml	35 42 43
PHOSPHATE No.2 LR	100	51 30 50 BT		
Combi pack#	each 100	51 76 51 BT		
PHOSPHATE No.1 LR / No.2 LR				
PHOSPHATE HR	100 250	51 19 80 BT 51 19 81 BT	13.5 mm cell, 10 ml	35 42 43
Details on request			13.5 mm cell, 10 ml	35 42 43
PHOSPHATE HR	100 250	51 19 80 51 19 81	13.5 mm cell, 10 ml	35 42 43
Vanadomolybdat- reagent	1 litre	46 84 04	13.5 mm cell, 10 ml	35 42 43
Details on request			Nessler tubes 113 mm	35 30 60
QAC LR	100 250	51 53 90 BT 51 53 91 BT	40 mm cell W680/40	60 68 90
ACIDIFYING GP	100 250	51 54 80 BT 51 54 81 BT		
QAC HR	100 250	51 54 00 51 54 01	13.5 mm cell, 10 ml	35 42 43
ACIDIFYING GP	100 250	51 54 80 BT 51 54 81 BT		
SILICA No.1	100 250	51 31 30 BT 51 31 31 BT	13.5 mm cell, 10 ml	35 42 43
SILICA No.2	100 250	51 31 40 BT 51 31 41 BT		
Combi pack#	each 100	51 76 71 BT		
SILICA No.1 / No.2	each 200	51 76 72 BT		
SILICA No.1/No.2			13.5 mm cell, 10 ml	35 42 43
Details on request			40 mm cell W680/40	60 68 90
Ammonia molybdate	100 ml	46 02 41	40 mm cell W680/40	60 68 90
Ammonia molybdate	100 ml	46 02 41	Nessleriser 2150 Nessler tubes 113 mm	17 21 50 35 30 60

Material Safety Data Sheets: www.lovibond.com



Test disc

Comparator 2000+

Tests, Discs, Reagents, Cells

Test	Disc	Disc Readings	Range	Code
Silica	NV	0.2; 0.3; 0.4; 0.5; 0.6; 0.7; 0.8; 0.9; 1.0 mg/l	0.2 - 1.0 mg/l SiO ₂	28 38 80
Sodiumhypochlorite	3/2 Hypo	2; 4; 6; 8; 10; 12; 14; 16 %	2 - 16 %	23 21 10
Sugar	3/29A	0; 5; 10; 15; 30; 45; 60; 75; 100 mg/l	0 - 100 mg/l	23 29 10
Sulphide	3/128	0; 0.05; 0.1; 0.15; 0.2; 0.25; 0.3; 0.4; 0.5 mg/l	0 - 0.5 mg/l S	23 02 10
Zinc	3/151	0; 0.1; 0.2; 0.3; 0.4; 0.5; 0.6; 0.8; 1 mg/l	0 - 1.0 mg/l	23 04 70
Zinc	3/102	0; 0.5; 1; 1.5; 2; 2.5; 3; 3.5; 4 mg/l	0 - 4.0 mg/l	23 00 20

including stirring rod



Certification for Comparator 2000+ Discs

To allow users to demonstrate that test equipment has been assessed for conformance with accepted quality standards, Lovibond® colour discs can be certified by Tintometer Group to conform to ISO 9001. If requested at the time of order, new discs are issued with a serial number and a certificate of conformance stating that the disc has satisfied the relevant inspection criteria and conforms to the requirements of the appropriate test. Depending on the requirements of the user's quality control system, used discs can be returned at regular intervals to Tintometer Group for checking and recertification.

Code	Type of certificate
999800	Certificate for a new test disc
999810	Certificate for a used test disc
999820	Calibration certificate for a new test disc
999830	Calibration certificate for a used test disc

Reagents	Quantity	Code	Accessories	Code
Details on request			Nessler tubes 113 mm	35 30 60
CHLORINE HR (KI)	100	51 30 00 BT	13.5 mm cell, 10 ml	35 42 43
	250	51 30 01 BT		
ACIDIFYING GP	100	51 54 80 BT		
	250	51 54 81 BT		
Combi pack [#]	each 100	51 77 21 BT		
CHLORINE HR (KI)/	each 250	51 77 22 BT		
ACIDIFYING GP				
Dilution set for sample preparation	1	41 44 70		
Details on request			5 mm cell W680/5	60 67 90
SULPHIDE No.1	100 (bottle)	50 29 30	13.5 mm cell, 10 ml	35 42 43
SULPHIDE No.2	100 (bottle)	50 29 40		
COPPER/ZINC LR	100	51 26 20 BT	13.5 mm cell, 10 ml	35 42 43
COPPER/ZINC LR	250	51 26 21 BT		
COPPER/ZINC HR	100	51 23 40	13.5 mm cell, 10 ml	35 42 43
COPPER/ZINC HR	250	51 23 41		

Material Safety Data Sheets: www.lovibond.com



Tablet reagents in foil blister strip (BT)

PHOTOMETRY



MD 100



MD 200



CSB Setups



MD 600 / 610



MultiDirect



SpectroDirect

Photometry

History

More than three decades have passed since the appearance of the first PC 100 photometer system.

Since that time, Tintometer has become a world-famous name as the manufacturer of photometer systems sold under the brand name of Lovibond®.

Our range of photometer systems extends from the **MD 100** as hand-held model, the multi parameter photometer **MD 200** as desktop model to the **SpectroDirect** spectrophotometer for laboratories.

The multi-functional **PM photometers** provide the answer to all requirements relating to the analysis of water used in modern swimming pools and baths. They offer a wide variety of pre-programmed methods and are therefore suitable for the demands of modern water analysis.

The **MultiDirect** offers a wide variety of pre-programmed methods and is therefore suitable for the demands of modern water and drinking water analysis.

A modern, mobile photometer for rapid, reliable water testing is the **MD 600**.

The latest development involves the photometer systems MD 610 and PM 630 with **Bluetooth®** data transmission. Both devices work wirelessly with the free app AqualX®.

All the parameters which can be measured with Lovibond® photometer systems are set out in the table. This table also explains what parameters can be measured with which photometer system.

Parameter	MD 100	MD 200	MD 600 & MD 610	MultiDirect	PM 620 & PM 630	PM 600	SpectroDirect	also compatible to Hach® devices*
Alkalinity-M	■	■	■	■	■	■	■	
Alkalinity-P			■	■			■	
Aluminium	■		■	■	■		■	see page 102
Ammonia	■		■	■	■		■	see page 102
Arsenic							■	
Boron			■	■			■	
Bromine	■	■	■	■	■	■	■	see page 102
Cadmium							■	
Calcium Hardness	■	■	■	■	■	■		
Chloride	■		■	■			■	
Chlorine	■	■	■	■	■	■	■	see page 102
Chlorine Dioxide	■	■	■	■	■		■	see page 102
Chromium			■				■	
COD	■	■	■	■			■	see page 102
Copper	■	■	■	■	■	■	■	see page 102
Cyanide			■	■			■	
Cyanuric acid	■	■	■	■	■	■	■	
DEHA	■		■	■			■	see page 102
Fluoride	■		■	■			■	
Formaldehyde							■	
Hazen (Pt-Co-Units ; APHA)	■		■	■			■	
Hydrazine	■		■	■			■	see page 104
Hydrogen Peroxide		■	■	■	■		■	
Iodine			■	■	■		■	
Iron (Fe ²⁺ , Fe ³⁺), soluble	■	■	■	■	■	■	■	see page 104
Langelier Water Balance System			■	■	■	■		
Lead							■	
Manganese	■		■	■			■	see page 104
Molybdate / Molybdenum	■		■	■			■	see page 104



MD 100



MD 200



MD 600 / 610

Parameter	MD 100	MD 200	MD 600 & MD 610	MultiDirect	PM 620 & PM 630	PM 600	SpectroDirect	also compatible to Hach® devices*
Nickel			■	■			■	
Nitrate		■	■				■	see page 104
Nitrite		■	■				■	see page 106
Oxygen, active			■	■	■			
Oxygen, dissolved	■		■	■				
Ozone	■		■	■	■	■	■	
pH-value	■	■	■	■	■	■	■	
Phenols							■	
PHMB (Biguanide)			■	■	■			
Phosphate	■		■	■	■	■	■	see page 106
Phosphonate			■	■			■	see page 106
Polyacrylates	■		■					
Potassium			■	■			■	
Silica	■		■	■			■	see page 106
Sodiumhypochlorite			■	■	■	■		
Spectral Absorption-Coefficient							■	
Sulphate	■		■	■	■		■	see page 106
Sulphide			■	■			■	
Sulphite			■	■			■	
Surfactants (anionic)							■	
Suspended Solids	■		■	■			■	
TOC							■	
Total Hardness	■		■	■	■		■	
Total Nitrogen			■	■			■	see page 104
Triazoles	■		■					
Turbidity (attenuated radiation method)			■	■			■	
Urea	■	■	■	■	■		■	
Zinc	■		■	■			■	

The principle of photometry

When specific reagents are added, the water sample takes on a degree of coloration that is proportional to the concentration of the parameter being measured. The photometer measures this coloration.

When a light beam passes through the coloured sample, energy with a specific wavelength is absorbed by the test substance. The photometer determines the coloration of the sample by measuring the transmission or absorption of light of this wavelength (in other words, monochromatic light). The photometer then uses a microprocessor to calculate the required concentration and displays the result.

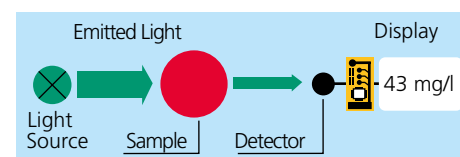

Mode of operation of the photometer



MultiDirect



SpectroDirect



PM 620

* HACH® is a registered trademark of Hach Company, Loveland, Colorado. The use of the HACH® trademark does not imply any affiliation with or approval by Hach Company regarding the formulation, testing or compatibility of these products for use in HACH® brand spectrophotometers or other devices or systems.

MD 100 Photometer

Precise Water Analysis in High-Quality Design

Small | Mobile | Rapid

The MD 100 uses high quality interference filters with long-life LEDs as a light source without any moving parts in a transparent sample chamber.

The units supply accurate, reproducible results very quickly. Other major advantages include ease of operation, ergonomic design, compact dimensions and safe handling.

The calibration and software-based adjustment options mean that the MD 100 is also suitable for use as a testing instrument.

The tests are conducted using either Lovibond® tablet reagents with long-term stability and a guaranteed minimum 5 or 10 year shelf life, VARIO powder reagents or using liquid reagents.

▶ Please see pages 78 onwards for reagents (order codes)

Highlights

- Scroll memory
- Automatic switch-off
- Real-Time-Clock and date
- Calibration mode
- Backlit display
- Storage function
- One Time Zero (OTZ)
- Waterproof*)

*) as defined in IP 68, 1 hour at 0.1 meter



Single-Parameter

Test	Code
Aluminium , tablet reagents 0.01 - 0.3 mg/l Al	27 62 00
Aluminium , powder reagents 0.01 - 0.25 mg/l Al	27 62 05
Ammonia , tablet reagents 0.02 - 1.0 mg/l N	27 60 60
Ammonium , powder reagents 0.01 - 0.8 mg/l N	27 60 65
Chloride , tablet reagents 0.5 - 25 mg/l Cl ⁻ 5 - 250 mg/l Cl ⁻ (by dilution)	27 61 80
Chlorine , tablet reagents (OTZ) 0.01 - 6.0 mg/l Cl ₂ / 0.1 - 10 mg/l Cl ₂ *	27 60 00
Chlorine , liquid reagent (OTZ) 0.02 - 4 mg/l Cl ₂	27 60 05
Chlorine DUO , for 2 types of reagents 1) Tablet reagents 0.01 - 6.0 mg/l Cl ₂ / 0.1 - 10 mg/l Cl ₂ *	27 60 20
2) Powder reagents 0.02 - 2.0 mg/l Cl ₂ (ø 24 mm glass vial) 0.1 - 8.0 mg/l Cl ₂ (ø 10 mm multi vial-2)	27 60 25
Chlorine , powder reagents 0.02 - 2.0 mg/l Cl ₂ (ø 24 mm glass vial) 0.1 - 8.0 mg/l Cl ₂ (ø 10 mm multi vial-2)	27 60 10
Chlorine HR (Potassium iodide) tablet reagents 5 - 200 mg/l Cl ₂ (ø 16 mm round vial & adapter)	27 61 70
Chlorine dioxide , tablet reagents 0.02 - 11 mg/l ClO ₂	27 60 30
Chlorine dioxide , powder reagents 0.04 - 3.8 mg/l ClO ₂	27 60 35
COD , tube tests, without reagents 0 - 150 mg/l O ₂ (ø 16 mm) 0 - 1500 mg/l O ₂ (ø 16 mm) 0 - 15000 mg/l O ₂ (ø 16 mm)	27 61 20
Copper , tablet reagents 0.05 - 5.0 mg/l Cu	27 60 80
Copper , powder reagents 0.05 - 5.0 mg/l Cu	27 60 85
Hardness, total , tablet reagents 2 - 50 mg/l CaCO ₃ 20 - 500 mg/l CaCO ₃ (by dilution)	27 61 90
Hazen , no reagents required 0 - 500 mg/l Pt-Co	27 61 60
Iron , tablet reagents 0.02 - 1.0 mg/l Fe	27 60 50
Iron TPTZ , powder reagents 0.02 - 1.8 mg/l Fe	27 60 55
Iron , powder reagents 0.02 - 3.0 mg/l Fe	27 60 56
Fluoride , without reagents 0.05 - 2.0 mg/l F ⁻	27 60 90
Manganese LR , tablet reagents 0.2 - 4.0 mg/l Mn	27 61 00
Manganese LR , powder reagents 0.01 - 0.7 mg/l Mn	27 61 05
Manganese HR , powder reagents 0.1 - 18 mg/l Mn	27 61 06
Molybdenum LR Powder reagents / reagent solution 0.03 - 3.0 mg/l Mo (mixing cylinder required, not included)	27 61 40
Molybdenum HR , powder reagents 0.3 - 40 mg/l Mo	27 61 41
Molybdenum , tablet reagents 0.6 - 30 mg/l Mo	27 61 42

Single-Parameter

Test	Code
Phosphate , tablet reagents 0.05 - 4.0 mg/l PO ₄	27 60 40
Phosphate , powder reagents 0.06 - 2.5 mg/l PO ₄	27 60 45
Silica , tablet reagents 0.05 - 4.0 mg/l SiO ₂	27 61 10
Silica LR , powder reagents 0.1 - 1.6 mg/l SiO ₂	27 61 15
Silica HR , powder reagents 1 - 90 mg/l SiO ₂	27 61 16
Suspended solids no reagents required 0 - 750 mg/l TSS	27 61 50
Urea , tablet reagents 0.1 - 2.5 mg/l Urea 0.2 - 5 mg/l Urea (by dilution)	27 62 10

2in1

Chlorine, pH , tablet reagents (OTZ) 0.01 - 6.0 mg/l Cl ₂ / 0.1 - 10 mg/l Cl ₂ * 6.5 - 8.4 pH	27 80 20
Chlorine, pH , liquid reagent (OTZ) 0.02 - 4 mg/l Cl ₂ / 6.5 - 8.4 pH	27 80 25
Chlorine, pH , powder reagents for chlorine 0.02 - 2.0 mg/l Cl ₂ (ø 24 mm glass vial) 0.1 - 8.0 mg/l Cl ₂ (ø 10 mm multi vial-2) 6.5 - 8.4 pH	27 80 30

3in1

Chlorine, pH, Cyanuric acid tablet reagents (OTZ) 0.01 - 6.0 mg/l Cl ₂ / 0.1 - 10 mg/l Cl ₂ * 6.5 - 8.4 pH ; 0 - 160 mg/l cyanuric acid	27 80 10
Chlorine, pH, Cyanuric acid liquid reagent for chlorine and pH (OTZ) 0.02 - 4 mg/l Cl ₂ / 6.5 - 8.4 pH 0 - 160 mg/l cyanuric acid	27 80 15
Chlorine, pH, Alkalinity-M tablet reagents (OTZ) 0.01 - 6.0 mg/l Cl ₂ / 0.1 - 10 mg/l Cl ₂ * 6.5 - 8.4 pH ; 5 - 200 mg/l CaCO ₃ (TA)	27 80 60
Chlorine, pH, Alkalinity-M (total) liquid reagent for chlorine and pH (OTZ) 0.02 - 4 mg/l Cl ₂ / 6.5 - 8.4 pH 5 - 200 mg/l CaCO ₃ (TA)	27 80 65
Chlorine LR, Chlorine HR, Chlorine dioxide [#] , tablet reagents 0.01 - 6.0 mg/l Cl ₂ 5 - 200 mg/l Cl ₂ (ø 16 mm round vial) 0.02 - 11 mg/l ClO ₂	27 80 00

4in1

Test	Code
Chlorine, pH, Cyanuric acid, Alkalinity-M , tablet reagents (OTZ) 0.02 - 6.0 mg/l Cl ₂ / 0.1 - 10 mg/l Cl ₂ * 6.5 - 8.4 pH ; 0 - 160 mg/l cyanuric acid 5 - 200 mg/l CaCO ₃ (TA)	27 80 70
Chlorine, pH, Cyanuric acid, Alkalinity-M (total) liquid reagent for chlorine and pH (OTZ) 0.02 - 4 mg/l Cl ₂ / 6.5 - 8.4 pH 0 - 160 mg/l cyanuric acid / 5 - 200 mg/l CaCO ₃ (TA)	27 80 75

5in1

Chlorine, pH, Cyanuric acid, Alkalinity-M, Calcium hardness tablet reagents (OTZ) 0.02 - 6.0 mg/l Cl ₂ / 0.1 - 10 mg/l Cl ₂ * 6.5 - 8.4 pH ; 0 - 160 mg/l cyanuric acid 5 - 200 mg/l CaCO ₃ (TA) ; 0 - 500 mg/l CaCO ₃ (CaH)	27 80 80
---	----------

6in1

Chlorine, Bromine, pH, Cyanuric acid, Alkalinity-M, Calcium hardness , tablet reagents (OTZ) 0.02 - 6.0 mg/l Cl ₂ / 0.1 - 10 mg/l Cl ₂ * 0.05 - 13 mg/l Br ; 6.5 - 8.4 pH 0 - 160 mg/l cyanuric acid ; 5 - 200 mg/l CaCO ₃ (TA) 0 - 500 mg/l CaCO ₃ (CaH)	27 80 90
--	----------

MD 100 Boiler Water

Aluminium, Chloride, Copper, DEHA, Hydrazine, Iron, Oxygen (dissolved), Phosphate, Polyacrylate, Silica (delivery without reagents)	27 62 30
---	----------

MD 100 Cooling Water

Aluminium, Bromine, Chlorine, Chlorine HR, Chlorine dioxide, Copper, Iron, Iron in Mo, Molybdate LR, Molybdate HR, Ozone, Polyacrylate, Sulphate, Triazoles, Zinc (delivery without reagents)	27 62 40
---	----------

* Delivery without reagents for measuring range 0.1 - 10 mg/l Cl₂

Where chlorine and chlorine dioxide are present together, they may be determined quantitatively as a single figure.

MD 100 Photometer



Scroll Memory (SM)

To avoid unnecessary scrolling for the required test method, the instrument memorizes the last method used before switching off the instrument. When the instrument is switched on again, the scroll list comes up with the last used test method first.

Zero Setting (OTZ)

For certain versions of the instrument it is not necessary to zero the instrument each time. The zero setting is held in memory until the device is turned off. (One Time Zero - OTZ). The zero setting can be confirmed whenever it is required.

Manufacturers Test Certificate M

Besides the "Certificate of Compliance" which is supplied with the MD 100, manufacturers test certificates M are available at cost on request. Manufacturers test certificates M are individually supplied per instrument and per method.

The manufacturers test certificate M has to be ordered together with the new instrument and cannot be delivered at a later stage.

N.I.S.T Traceability

The instrument has a factory calibration, which is related to international standards which are not N.I.S.T traceable. The instrument may be calibrated by the user in a "user calibration mode" with N.I.S.T traceable standards.

(N.I.S.T. = National Institute of Standards and Technology)

Delivery Content

- Instrument in carrying case
- 4 micro batteries (AAA)
- 3 Round vials (glass) with lid
- 1 stirring rod & 1 brush
- Tablet reagents and/or liquid reagents or VARIO Powder reagent
- Warranty information
- Certificate (COC)
- Instruction Manual

Technical Data

Optics	LEDs, interference filters (IF) and photo sensor in transparent sample chamber. Depending on the version, up to 3 different interference filters are used. Wavelength specifications of interference filters: 430 nm $\Delta\lambda = 5$ nm 530 nm $\Delta\lambda = 5$ nm 560 nm $\Delta\lambda = 5$ nm 580 nm $\Delta\lambda = 5$ nm 610 nm $\Delta\lambda = 6$ nm 660 nm $\Delta\lambda = 5$ nm
Wavelength Accuracy	± 1 nm
Photometric Accuracy⁴⁾	3 % FS (T = 20 °C – 25 °C)
Photometric Resolution	0.01 A
Power Supply	4 micro batteries (AAA), capacity approx. 17 hours or 5000 tests
Auto - OFF	automatic switch-off
Display	backlit LCD (on keypress)
Storage	internal ring memory for 16 data sets
Interfaces	infrared interface for test data transfer
Additional feature	real time clock and date
Calibration	factory calibration and user calibration. Reset to factory calibration possible
Dimensions	155 x 75 x 35 mm (L x W x H)
Weight	basic unit approx. 260 g
Environmental conditions	temperature: 5–40 °C rel. humidity: 30–90 % (non condensing)

CE-Conformity

⁴⁾ tested with standard solutions



Accessories

Item	Code
Set of 12 round vials with lid Height 48 mm, Ø 24 mm	19 76 20
Set of 5 round vials with lid Height 48 mm, Ø 24 mm	19 76 29
Set of 10 round vials with lid Height 90 mm, Ø 16 mm	19 76 65
Adapter for round vials Ø 16 mm	19 80 21 90
Set of 12 plastic vials (PC), with lid "Multi"-Type 2, Ø 10 mm	19 76 00
Vial stand for 6 round vials Ø 24 mm, acrylic glass	41 89 51
Vial stand for 10 vials (Ø 16 mm or □ 13,5 mm), acrylic glass	41 89 57
Mixing cylinder, 25 ml, with stopper required accessory for molybdenum LR test with MD 100 (276140)	19 80 26 50
Membrane filter set for use when preparing samples, 25 membrane filters, 0,45 µm, 2 syringes 20 ml	36 61 50
Cleaning cloth for vials	19 76 35
Set of 12 sealing rings for round vial Ø 24 mm	19 76 26
4 micro batteries (AAA)	19 50 026
Measuring beaker, volume 100 ml	38 48 01
Plastic funnel with handle	47 10 07
Plastic stirring rod, 13 cm length	36 41 00
Plastic stirring rod, 13 cm length, (10 pc.)	36 41 20
Plastic stirring rod, 10 cm length	36 41 09
Plastic stirring rod, 10 cm length, (10 pc.)	36 41 30
Infrared data transfer module IRiM	21 40 50



 Please see pages 78 onwards for reagents (order codes)



Data transfer

The optional available IRiM (infrared interface module) uses modern infrared technology to transmit measurement data from the MD 100 photometer to one of 3 optional interfaces. These interfaces can be used to connect to a PC, a USB printer¹⁾ or alternatively a serial printer²⁾.

The unit is supplied complete with data logging software providing easy and rapid transfer of data to the PC. As an option, the data can be saved as an Excel sheet or a .txt file.

Measurement data can quickly be printed out, using a specified¹⁾ USB or alternatively a printer with a serial plug-in connected to the IRiM.

Applicable for the following operating systems: Windows® XP, Windows® Vista and Windows® 7/10.

¹⁾ USB printer: HP Deskjet 6940 ; ²⁾ each ASCII printer
Windows® is a registered Trademark of Microsoft Corporation

Verification Standard Kit

The verification standard kit for the MD 100 is designed to assure the user of the accuracy and the reliability of the results related to the integrated wave lengths.

The kit contains one zero standard, 6 different vials for checking 6 different wave lengths and allows checking the complete range of MD 100 photometers.

The shelf life of the verification standard kit is two years from the date of production, provided that storage and use are in accordance with the instructions provided.

Verification Standard Kit 21 56 70

Reference Standard Kit for MD 100

The reference standards are designed to check the accuracy and the reliability of the results.

It is not possible to calibrate the photometer with the reference standards.

The shelf life of reference standards is two years from the date of production, provided that storage and use are in accordance with the instructions provided.

Kit Chlorine for instruments with tablet / liquid reagent 0.2* and 1.0* mg/l 27 56 50

Kit Chlorine for instruments with tablet / liquid reagent 0.5* and 2.0* mg/l 27 56 55

Kit Chlorine for instruments with tablet / liquid reagent 1.0* and 4.0* mg/l 27 56 56

Kit Chlorine for instruments with powder reagent (VARIO) 0.2* and 1.0* mg/l 27 56 60

Kit pH for instruments with tablet / liquid reagent 7,45* pH 27 56 70

* Approximate figure, actual figure specified in Certificate of Analysis



MD 200 Photometer



Precise results
using high-quality
interference filters

Highlights

- Scroll memory
- Automatic switch-off
- Real-Time-Clock and date
- Calibration mode indicator
- Backlit display
- Storage function
- One Time Zero (OTZ)
- Waterproof^{*)}

*) as defined in IP 68, 1 hour at 0.1 meter, buoyant

Single Parameter

Test	Code
COD , tube tests, without reagents 0 - 150 mg/l O ₂ (ø 16 mm) 0 - 1500 mg/l O ₂ (ø 16 mm) 0 - 15000 mg/l O ₂ (ø 16 mm)	28 92 502

4in1

Test	Code
Chlorine, pH, Cyanuric acid, Alkalinity-M tablet reagents 0.01 - 6.0 mg/l Cl ₂ / 0.1 - 10 mg/l Cl ₂ * 6.5 - 8.4 pH / 0 - 160 mg/l cyanuric acid 5 - 200 mg/l CaCO ₃ (TA)	28 60 502
Chlorine, pH, Cyanuric acid, Alkalinity-M liquid reagents for chlorine and pH 0.02 - 4 mg/l Cl ₂ / 6.5 - 8.4 pH 0 - 160 mg/l cyanuric acid / 5 - 200 mg/l CaCO ₃ (TA)	28 60 542

6in1

Test	Code
Chlorine, Bromine, pH, Cyanuric acid, Alkalinity-M, Calcium hardness tablet reagents 0.01 - 6.0 mg/l Cl ₂ / 0.1 - 10 mg/l Cl ₂ * 0.05 - 13 mg/l Br / 6.5 - 8.4 pH 0 - 160 mg/l cyanuric acid / 5 - 200 mg/l CaCO ₃ (TA) 0 - 500 mg/l CaCO ₃ (CaH)	28 61 902
Chlorine, pH, Cyanuric acid, Alkalinity-M, Copper, Iron tablet reagents 0.01 - 6.0 mg/l Cl ₂ / 0.1 - 10 mg/l Cl ₂ * 6.5 - 8.4 pH / 0 - 160 mg/l cyanuric acid 5 - 200 mg/l CaCO ₃ (TA) / 0.05 - 5 mg/l Cu 0.02 - 1 mg/l Fe ^{2+/3+}	28 62 102

2in1

Test	Code
Chlorine, pH , tablet reagents 0.01 - 6.0 mg/l Cl ₂ / 0.1 - 10 mg/l Cl ₂ * 6.5 - 8.4 pH	28 89 402
Chlorine, pH , liquid reagents 0.02 - 4 mg/l Cl ₂ / 6.5 - 8.4 pH	28 89 412
Copper, pH tablet reagents 0.05 - 5 mg/l Cu / 6.5 - 8.4 pH	28 72 102
Hydrogen peroxide, pH (no OTZ) liquid reagents 1 - 50 mg/l H ₂ O ₂ / 40 - 500 mg/l H ₂ O ₂ 6.5 - 8.4 pH	28 88 102

5in1

Test	Code
Chlorine, pH, Cyanuric acid, Alkalinity-M, Calcium hardness tablet reagents 0.01 - 6.0 mg/l Cl ₂ / 0.1 - 10 mg/l Cl ₂ * 6.5 - 8.4 pH / 0 - 160 mg/l cyanuric acid 5 - 200 mg/l CaCO ₃ (TA) / 0 - 500 mg/l CaCO ₃ (CaH)	28 61 202

* Delivery without reagents
for measuring range 0.1 - 10 mg/l Cl₂

3in1

Test	Code
Chlorine, pH, Bromine tablet reagents 0.01 - 6.0 mg/l Cl ₂ / 0.1 - 10 mg/l Cl ₂ * 6.5 - 8.4 pH / 0.05 - 13 mg/l Br	28 61 802
Chlorine, pH, Cyanuric acid tablet reagents 0.01 - 6.0 mg/l Cl ₂ / 0.1 - 10 mg/l Cl ₂ * 6.5 - 8.4 pH / 0 - 160 mg/l cyanuric acid	28 60 102
Chlorine, pH, Cyanuric acid liquid reagents for chlorine and pH 0.02 - 4 mg/l Cl ₂ / 6.5 - 8.4 pH 0 - 160 mg/l cyanuric acid	28 82 002
Chlorine, pH, Alkalinity-M tablet reagents 0.01 - 6.0 mg/l Cl ₂ / 0.1 - 10 mg/l Cl ₂ * 6.5 - 8.4 pH / 5 - 200 mg/l CaCO ₃ (TA)	28 89 002
Chlorine, pH, Alkalinity-M liquid reagents for chlorine and pH 0.02 - 4 mg/l Cl ₂ / 6.5 - 8.4 pH 5 - 200 mg/l CaCO ₃ (TA)	28 89 302

Delivery Content

- Instrument in carrying case
- 4 batteries (AA)
- 3 round vials (glass) with lid
- 1 stirring rod, 1 brush & 1 syringe
- Tablet reagents and/or liquid reagents
- Warranty information
- Certificate (Certificate of Compliance)
- Instruction Manual



MD 200 Photometer

Designed to meet the latest technical requirements, the MD 200 photometer can be used in practically every area of water analysis.

The high-precision optics and top-quality interference filters use long-term stable LEDs as light-source. Because there are no moving parts, the entire measurement device requires absolutely no maintenance.

Precise and reproducible analysis results are obtained in a short time. The units impress with their user-friendliness, ergonomic design, compact dimensions and easy handling.

The tests are conducted using either Lovibond® tablet reagents, with long-term stability and a guaranteed minimum 5 or 10 year shelf life, or using liquid reagents.

Scroll Memory (SM)

For multi-parameter instruments, the order of the various methods is determined. To avoid unnecessary scrolling for the required test method, the instrument memorizes the last method used before switching off the instrument. When the instrument is switched on again, the scroll list comes up with the last used test method first. This allows for faster access to favoured methods.

Zero Setting (OTZ)

It is not necessary to zero the instrument each time. The zero setting is held in memory until the device is turned off (**One Time Zero - OTZ**). The zero setting can be confirmed whenever it is required.

Technical Data

Optics	LEDs, interference filters (IF) and photo sensor in transparent sample chamber. Depending on the version, up to 3 different interference filters are used. Wavelength specifications of interference filters: 430 nm $\Delta\lambda = 5$ nm 530 nm $\Delta\lambda = 5$ nm 560 nm $\Delta\lambda = 5$ nm 610 nm $\Delta\lambda = 6$ nm
Wavelength Accuracy	± 1 nm
Photometric Accuracy⁴⁾	3 % FS (T = 20 °C – 25 °C)
Photometric Resolution	0.01 A
Power Supply	4 batteries (AA), capacity approx. 53 hours or 15000 tests (continuous operation without display lighting)
Auto - OFF	automatic switch-off
Display	backlit LCD (on keypress)
Storage	internal ring memory for 16 data sets
Interface	infrared interface for test data transfer to IRiM
Additional feature	real time clock and date
Calibration	factory calibration and user calibration. Reset to factory calibration possible
Dimensions	190 x 110 x 55 mm (L x W x H)
Weight	basic unit approx. 455 g (with batteries)
Environmental conditions	temperature: 5–40 °C rel. humidity: 30–90 % (non condensing)

CE-Conformity

⁴⁾ tested with standard solutions

Accessories

Item	Code
Set of 12 round vials with lid Height 48 mm, Ø 24 mm	19 76 20
Set of 5 round vials with lid Height 48 mm, Ø 24 mm	19 76 29
Adapter for round vials ø 16 mm	19 80 21 90
Membrane filter set for use when preparing samples, 25 membrane filters, 0,45 µm, 2 syringes 20 ml	36 61 50
Vial stand for 6 round vials Ø 24 mm, acrylic glass	41 89 51
Vial stand for 10 vials (Ø 16 mm or □ 13,5 mm), acrylic glass	41 89 57
Cleaning cloth for vials	19 76 35
Set of 12 sealing rings for round vial ø 24 mm	19 76 26
4 batteries (AA)	19 50 025
Battery lid	19 80 22 41
Measuring beaker, volume 100 ml	38 48 01
Plastic stirring rod, 13 cm length	36 41 00
Plastic stirring rod, 13 cm length, (10 pc.)	36 41 20
Plastic stirring rod, 10 cm length	36 41 09
Plastic stirring rod, 10 cm length, (10 pc.)	36 41 30
Infrared data transfer module IRiM	21 40 50



➔ Please see pages 78 onwards for reagents (order codes)



Data Transfer

The optional available IRiM (infrared interface module) uses modern infrared technology to transmit measurement data from the MD 200 photometer to one of 3 optional interfaces. These interfaces can be used to connect to a PC, a USB printer¹⁾ or alternatively a serial printer²⁾.

The unit is supplied complete with data logging software providing easy and rapid transfer of data to the PC. As an option, the data can be saved as an Excel sheet or a .txt file.

Measurement data can quickly be printed out, using a specified¹⁾ USB or alternatively a printer with a serial plug-in connected to the IRiM.

Applicable for the following operating systems: Windows XP, Windows Vista and Windows 7/10.

¹⁾ USB printer: HP Deskjet 6940 ; ²⁾ each ASCII printer
Windows® is a registered Trademark of Microsoft Corporation

Manufacturers Test Certificate M

Besides the "Certificate of Compliance" which is supplied with the MD 200, manufacturers test certificates M are available at cost on request. Manufacturers test certificates M are individually supplied per instrument and per method.

The manufacturers test certificate M has to be ordered together with the new instrument and cannot be delivered at a later stage.

Verification Standard Kit

The verification standard kit for the MD 200 is designed to assure the user of the accuracy and the reliability of the results related to the integrated wave lengths.

The kit contains one zero standard, 6 different vials for checking 6 different wave lengths and allows for checking the complete range of MD 200 photometers.

The shelf life of the verification standard kit is two years from the date of production, provided that storage and use are in accordance with the instructions provided.

Measurements are taken in mAbs.

Verification Standard Kit 21 56 70

Reference Standard Kits

The reference standards are designed to check the accuracy and the reliability of the results.

It is not possible to calibrate the photometer with the reference standards.

The shelf life of reference standards is two years from the date of production, provided that storage and use are in accordance with the instructions provided.

Kit Chlorine for instruments with tablet / liquid reagent 0.2* and 1.0* mg/l 27 56 50

Kit Chlorine for instruments with tablet / liquid reagent 0.5* and 2.0* mg/l 27 56 55

Kit Chlorine for instruments with tablet / liquid reagent 1.0* and 4.0* mg/l 27 56 56

Kit pH for instruments with tablet / liquid reagent 7,45* pH 27 56 70

* Approximate figure, actual figure specified in certificate of analysis enclosed



➔ Please see pages 78 onwards for reagents (order codes)

COD Setups COD VARIO (ISO 15705:2002) COD Photometer

Determination of the chemical oxygen demand index (ST-COD)

Small-scale sealed-tube
Total range 0 - 15000 mg/l



Waste water parameter COD

The chemical oxygen demand, ST-COD value (ST = small scale sealed tube), of water as determined by this dichromate method can be considered as an estimate of the theoretical oxygen demand, i.e. the amount of oxygen consumed in total chemical oxidation of the organic constituents present in the water.

COD VARIO Photometers

With a measuring range from 0 to 15,000 mg/l O₂, the Lovibond® COD VARIO photometers are suitable for waste water testing.

Two LEDs light sources with long-term stability ($\lambda_1 = 610 \text{ nm}$; $\lambda_2 = 430 \text{ nm}$, according to ISO 15705:2002), a waterproof sample chamber, a large digital display, and the user-friendly keypad ensure maximum operating reliability and convenience.

MD 100 COD VARIO Order code: 27 61 20
(MD 100 photometer only in case)

MD 200 COD VARIO Order code: 289 25 02
(MD 200 photometer only in case)

Setups COD VARIO

The Lovibond® COD VARIO Setups allow highly sensitive and precise water testing with minimum effort. They measure the ST-COD concentration by photometric detection employing a linear relationship between absorbance and concentration.

After adding the sample to a Lovibond® COD VARIO tube test (LR, MR according to ISO 15705:2002), it is heated in the reactor for two hours at 150 °C and then analysed in the photometer.

The COD Setups comprise the photometer, 25 tube tests for each of the two lower measuring ranges, a reactor for sample digestion, and a vial stand.

COD Setup Order code: 27 61 30
MD 100 COD VARIO

Instrument in carrying case, 4 batteries (AAA), adapter for round vials $\varnothing 16 \text{ mm}$, 2 sets of tube tests 0-150 mg/l, 0-1500 mg/l, thermoreactor RD 125, tube stand, 2 syringes 1 ml, 2 ml, warranty information, certificate (COC), instruction manual

COD Setup Order code: 289 26 02
MD 200 COD VARIO

Instrument in carrying case, 4 batteries (AA), adapter for round vials $\varnothing 16 \text{ mm}$, 2 sets of tube tests 0-150 mg/l, 0-1500 mg/l, thermoreactor RD 125, tube stand, 2 syringes 1 ml, 2 ml, warranty information, certificate (COC), instruction manual

Ranges

0 – 150 mg/l O₂ $\pm 3,5 \%$ FS
0 – 1500 mg/l O₂ $\pm 3,5 \%$ FS
0 – 15000 mg/l O₂ $\pm 3,5 \%$ FS

* tolerance based on the use of potassium-hydrogenephtalate standards (DIN 38409)

COD VARIO tube tests

The Lovibond® COD VARIO tube tests are available for the measuring ranges 0-150 mg/l O₂, 0-1500 mg/l O₂ and 0-15000 mg/l O₂. Their chemical properties and a 16 mm tube diameter make them compatible to Hach® devices.*

Tube tests	Order code
0-150 mg/l O₂ (25 pc.), mercury free** (25 pc.) (150 pc.)	2 42 07 10 2 42 07 20 2 42 07 25
0-1500 mg/l O₂ (25 pc.), mercury free** (150 pc.), mercury free** (25 pc.) (150 pc.)	2 42 07 11 2 42 07 16 2 42 07 21 2 42 07 26
0-15000 mg/l O₂ (25 pc.), mercury free** (25 pc.) (150 pc.)	2 42 07 12 2 42 07 22 2 42 07 27

** without chloride removal

Standard solutions

Standard solutions are solutions with a defined concentration and are provided to check the operation methods and devices of the cuvette tests as well as the condition of optical filters and the instrument.

Standard solution	Quantity	Code
100 mg/l COD	30 ml	2 42 08 03
500 mg/l COD	30 ml	2 42 08 04
5000 mg/l COD	10 ml	2 42 08 05

Highlights

- ST-COD sealed tubes ready for use
- Suppression of chloride interference up to 1000 mg/l (LR & MR) up to 10000 mg/l (HR)
- Mercury free tube tests, in absence of chloride interference
- 3 ranges:
Low range:
0 - 150 mg/l, meets ISO 15705:2002
Middle range:
0 - 1500 mg/l, meets ISO 15705:2002
High range:
0 - 15000 mg/l

Thermoreactor RD 125

For the Tube test digestion of:

COD (150 °C)

TOC (120 °C)

Total Chromium (100 °C)

Total Nitrogen (100 °C)

Total Phosphate (100 °C)



Chemical digestion of samples is required for the photometric determination of COD, TOC, total phosphate and total nitrogen.

The required temperatures and reaction time can be selected by using the membrane keypad of the reactor RD 125. The unit works at three different temperatures (100 / 120 / 150 °C) and three pre-set reaction times 30 / 60 / 120 minutes). When digestion is complete, the reactor automatically switches off and gives a corresponding LED indication with short beep alarm.

The RD 125 reactor is fitted with 24 holes for 16 mm diameter vials.

With the voltage switch on the back 230 V and 115 V are selectable.

COD Reactor RD 125 Order code: 2 41 89 40

Technical data RD 125

Power supply	230 V / 50-60 Hz or 115 V / 50-60 Hz (switchable)
Power	550 W
Dimensions	248 x 219 x 171 mm
Weight	3.9 kg
Materials, housing	ABS
Protection grid	PPS
Lid	PC
Block insert	PBT
Heating block	Aluminium
Holes in the aluminium block	24 holes, 16.2 mm ± 0.2 mm
Selectable temp.	100 / 120 / 150 °C
Probe type	Pt100 A class
Temperature stability	± 1 °C at the Pt100
Selected time	30 / 60 / 120 / min. and continuous operation (∞)
Heating up	from 20 °C to 150 °C in 12 min.
Regulation	Microprocessor
Protection against overheating	at the alu block at 190 °C
Beeper	max. 88 dB (piezo buzzer)
Environmental conditions	10 – 40 °C max. 85 % rel. humidity

CE-Conformity

Photometry

Waste Water Setups

Waste Water Setup MD 600 21 41 00

Photometer MD 600 with standard accessory, thermo reactor RD 125, Infrared data transmission module IRiM, tube stand, membrane filter set, instruction manual, warranty information
COD 0 - 150 mg/l and 0 - 1500 mg/l,
Ammonia 1 - 50 mg/l N,
Nitrate 1 - 30 mg/l N
Nitrite LR 0,01 - 0,3 mg/l N
Nitrogen 5 - 150 mg/l N
Phosphate 0.02 - 1 mg/l P / 0.06 - 3.5 mg/l PO₄

Waste Water Setup SpectroDirect 71 21 00

Spectrophotometer SpectroDirect, thermo reactor RD 125, 5 round vials ø 24 mm, tube stand, membrane filter set, instruction manual, warranty information
COD 0 - 150 mg/l and 0 - 1500 mg/l,
Ammonia 1 - 50 mg/l N,
Nitrate 1 - 30 mg/l N
Nitrite LR 0,01 - 0,3 mg/l N
Nitrogen 5 - 150 mg/l N
Phosphate 0.02 - 1 mg/l P / 0.06 - 3.5 mg/l PO₄

Reagents

COD 0-150 mg/l O ₂ (25 pc.), mercury free ** (25 pc.)	2 42 07 10
(150 pc.)	2 42 07 20
	2 42 07 25
CSB 0-1500 mg/l O ₂ (25 pc.), mercury free ** (150 pc.), mercury free ** (25 pc.)	2 42 07 11
(150 pc.)	2 42 07 16
	2 42 07 21
	2 42 07 26
CSB 0-15000 mg/l O ₂ (25 pc.), mercury free ** (25 pc.)	2 42 07 12
(150 pc.)	2 42 07 22
** without chloride removal	2 42 07 27
Ammonia VARIO HR tube test	53 56 50
Nitrate VARIO tube test	53 55 80
Nitrite LR VARIO powder pack	53 09 80
Nitrogen VARIO Total HR tube test	53 55 60
Phosphate VARIO Total HR tube test	53 52 10

Accessories

Set of round vials with lids Height 48 mm, Ø 24 mm	19 76 29
Membrane filter set for use when preparing samples, 25 membrane filters 0.45 µm, 2 syringes 20 ml	36 61 50
Vial stand for 6 round vials Ø 24 mm, acrylic glass	41 89 51
Vial stand for 10 vials (Ø 16 mm or □ 13,5 mm), acrylic glass	41 89 57
Automatic pipette*, 1 - 5 ml	41 90 76
Pipette tips*, 1 - 5 ml (white), 100 pc.	41 90 66
Automatic pipette**, 0.1 - 1 ml	41 90 77
Pipette tips**, 0.1 - 1 ml (white), 1000 pc.	41 90 73

* 0 - 150 mg/l and 0 - 1500 mg/l ; ** 0 - 15000 mg/l

MD 600 & MD 610 Photometer



Modern, mobile photometer for rapid, reliable water testing

Highlights

- Highest/reproducible precision with interference filter
- Display with background lighting
- More than 120 pre-programmed methods
- Automatic selection of wavelength
- User guidance in German, English, French, Spanish, Italian, Portuguese (BR), Polish, and Indonesian.
- Buffer for up to 1000 data records
- More than 35 user-specific methods possible
- Bluetooth® interface for connection to smart phones and tablets (only with MD 610)*
- iOS® and Android™ app for data management and email delivery (only with MD 610)*
- Infrared interface (only with MD 600)
- Waterproof housing*
- Handheld format, portable

*1 analog IP 68, 1 Stunde bei 0,1 Meter

The MD 610 and MD 600 give you mobile devices in a modern design with the analytical features of laboratory photometers.

All important water analysis parameters from A(luminium) to Z(inc) are covered by these two devices. Combined with the high precision of Lovibond® reagents, a reliable and quick analysis of water samples is guaranteed. Reagent tablets, powder reagents, liquid reagents, or cuvette tests are used depending on the method.

Six long-lasting LEDs serving as a light source in combination with interference filters guarantee the highest precision. The devices are designed without moving optical parts and thus have a maintenance-free measuring unit. Up to 1,000 data records can be stored in both the MD 610 and the MD 600.

The **AquaLX®** app, available free of charge, offers the possibility of transferring measurements to smart phones or tablets via **Bluetooth®**. The data management then enables analysis and export as a CSV file or graph via email. The app is available free of charge for Android™ and iOS®.

The proven MD 600 photometer uses the classic infrared interface with which data can be transferred by means of the IRiM module to the PC or laptop.



N.I.S.T. Traceability

The instrument has a factory calibration, which is related to international standards, which are not N.I.S.T. traceable. The instrument may be calibrated by the user in a "user calibration mode" with N.I.S.T. traceable standards.

(N.I.S.T. = National Institute of Standards and Technology)

New methods

Test methods are regularly updated to suit market requirements. You can find software updates for new methods and additional languages on our website at www.lovibond.com.

Polynomials

With the help of an external mathematical program, the corresponding polynomial is created from data pairs (concentration/absorption). A known polynomial may also be used. 25 order polynomials ($y = A+Bx+Cx^2 + Dx^3 + Ex^4 + Fx^5$) can be stored together with user-specific parameters such as wavelength, measuring range, unit and number of decimals.

Concentration

This function can be used to measure 2 to 14 known standards. On the basis of the concentrations/absorption pairs obtained, the photometer will calculate a linear interpolation between the measured points. Up to 10 methods can be stored for further sample measurements.

Verification Standard Kit

The verification standard kit for the MD 600 / 610 is designed to assure the user of the accuracy and the reliability of the results related to the integrated wave lengths.

The shelf life of the verification standard kit is two years from the date of production, provided that storage and use are in accordance with the instructions provided.

Verification Standard Kit 21 56 40

 Please see pages 78 onwards for reagents (order codes)

Delivery Content

- Instrument in carrying case
- 4 batteries
- 3 Round vials each 24 and 16 mm ø
- 1 adapter each for 16 mm and 13 mm vials
- Plastic stirring rod 13 cm, Brush 11 cm, screw driver
- Warranty information
- Certificate of Compliance
- Instruction Manual

Order codes (without reagents)

MD 600: 21 40 20

MD 610: 21 40 25

Please specify the reagents or parameters required at time of order.

You can find updated information on parameters and measuring ranges on our website at www.lovibond.com

Applications

- Waste Water
- Drinking Water
- Industrial Process Water
- Science & Research
- Governmental and Private Laboratories
- Mobile Applications



MD 600 & MD 610 Photometer



Technical Data

Display	Backlit graphic-display
Interfaces	Infrared ¹ (MD 600), Bluetooth® 4.0 (MD 610) RJ45 socket for Internet updates ²
Optics	LEDs, interference filters (IF) and photo sensor in transparent sample chamber Wavelength range: 430 nm IF $\Delta\lambda = 5$ nm 530 nm IF $\Delta\lambda = 5$ nm 560 nm IF $\Delta\lambda = 5$ nm 580 nm IF $\Delta\lambda = 5$ nm 610 nm IF $\Delta\lambda = 6$ nm 660 nm IF $\Delta\lambda = 5$ nm IF = interference filter
Wavelength Accuracy	± 1 nm
Photometric Accuracy*	2 % FS (T = 20 °C – 25 °C)
Photometric Resolution	0.005 A

Operation	Acid and solvent resistant, touch-sensitive keypad with audible feedback via integrated beeper
Power Supply	4 batteries (Mignon AA/LR6); Operation time: approx. 26 h continuous operation or 3500 tests
Auto-Off	approx. 20 minutes after last keypress with audible signal
Dimensions	approx. 210 x 95 x 45 mm (unit) approx. 395 x 295 x 106 mm (case)
Weight (unit)	approx. 450 g
Ambient Conditions	5–40 °C at max. 30–90 % rel. humidity (non condensing)
Language Selection	German, English, French, Spanish, Italian, Portuguese, Polish, Indonesian ; additional languages via Internet update
Memory Capacity	approx. 1000 data sets
CE-Conformity	

¹ optional available: IRiM (Infrared Interface Modul)

² optional available: connection cable with integrated electronics
(RS 232 / RJ-45 plug)

* tested with standard solutions

Accessories

Item	Code
Set of 12 round vials with lid Height 48 mm, Ø 24 mm	19 76 20
Set of 10 round vials with lid Height 90 mm, Ø 16 mm	19 76 65
Adapter for round vials Ø 16 mm	19 80 21 90
Adapter for round vials Ø 13 mm	19 80 21 92
Set of multy vials-3 with lids path length 10 mm, 10 ml volume Height 48 mm, Ø 24 mm (12 pc.)	19 76 05
Vial stand for 6 round vials Ø 24 mm, acrylic glass	41 89 51
Vial stand for 10 vials (Ø 16 mm or □ 13,5 mm), acrylic glass	41 89 57
Sealing ring for vial Ø 24 mm (12 pc.)	19 76 26
Battery, 1.5 V, AA-Alkali-Mangan (4 pc.)	19 50 025
Cleaning cloth for vials	19 76 35
Plastic funnel with handle	47 10 07
Plastic stirring rod, 13 cm length	36 41 00
Plastic stirring rod, 13 cm length, (10 pc.)	36 41 20
Plastic stirring rod, 10 cm length	36 41 09
Plastic stirring rod, 10 cm length, (10 pc.)	36 41 30
Cleaning brush, 10 cm	38 02 30
Verification Standard Kit	21 56 40
Cable for update for connection to a PC	21 40 30
Data transmission modul IRiM	21 40 50

 Please see pages 78 onwards for
reagents (order codes)



Infrared data transmission modul IRiM



The IRiM (infrared interface modul) uses modern infrared technology to transmit measurement data from the MD 600 photometer to one of 3 optional interfaces. These interfaces can be used to connect to a PC, a USB printer¹⁾ or alternatively a serial printer²⁾. The interface which is selected is displayed by an LED function indicator. The user can switch between the interfaces using the „Select“ button.

The unit is supplied complete with data logging software providing easy and rapid transfer of data to the PC. As an option, the data can be saved as an Excel sheet or a .txt file.

Measurement data can quickly be printed out, using a specified¹⁾ USB or alternatively a printer with a serial plug-in connected to the IRiM.

Applicable for the following operating systems: Windows XP, Windows Vista and Windows 7/10.

¹⁾ USB printer: HP Deskjet 6940 ; ²⁾ each ASCII printer

Delivery content

The IRiM is delivered ready for use, with the following accessories :

USB cable, 4 batteries, screwdriver, CD-ROM, operating instructions and guarantee certificate

Order code: 21 40 50

MultiDirect Photometer



The MultiDirect is a contemporary, microprocessor-controlled photometer with ergonomically designed keypad and large-format graphic display. It is equipped with a wide range of pre-programmed methods based on the proven range of Lovibond® tablet reagents, liquid reagents, tube tests and powder reagents (VARIO Powder Packs). Users can also store their own methods.

The MultiDirect is a filter photometer using interference filters at 6 different wavelengths. The unique design of the optics allows the automatic selection of the required wavelength without any moving parts. This and the dual beam technology utilizing an internal reference channel, guarantees the highest accuracy.

For portable use, the instrument operates with seven standard rechargeable batteries (supplied). These batteries are available all over the world and are easily changed. The integrated intelligent charge controller allows simultaneous operation of the unit and battery charging (using the supplied power pack). The MultiDirect also operates without a power pack by using alkaline manganese batteries.

The entire instrument, including sample chamber (the most critical component of any photometer) and battery compartment, is waterproof, ensuring that no water comes in contact with the electronic components.

N.I.S.T. Traceability

The instrument has a factory calibration, which is related to international standards, which are not N.I.S.T traceable. The instrument may be calibrated by the user in a "user calibration mode" with N.I.S.T traceable standards.

(N.I.S.T. = National Institute of Standards and Technology)

New methods

Test methods are regularly updated to suit market requirements. You can find software updates for new methods and additional languages on our website at www.lovibond.com.

Polynomials

With the help of an external mathematical program, the corresponding polynomial is created from data pairs (concentration/absorption). A known polynomial may also be used. 25 order polynomials ($y = A+Bx+Cx^2 +Dx^3 +EX^4 + FX^5$) can be stored together with user-specific parameters such as wavelength, measuring range, unit and number of decimals.

Concentration

This function can be used to measure 2 to 14 known standards. On the basis of the concentrations/absorption pairs obtained, the photometer will calculate a linear interpolation between the measured points. Up to 10 methods can be stored for further sample measurements.



Highlights

- Dual Beam Technology and Interference Filters for highest accuracy
- A wide range of pre-programmed methods
- Long-term stable LEDs as light sources
- Update of new methods and languages via Internet (free of charge)
- Interface
- Memory for 1000 data sets
- Mobile

➔ Please see pages 78 onwards for reagents (order codes)

Applications

- Waste Water
- Drinking Water
- Industrial Process Water
- Science & Research
- Governmental and Private Laboratories
- Mobile Applications

MultiDirect Photometer



Delivery Content

- Instrument in carrying case
 - 7 rechargeable batteries
 - 1 lithium battery
 - Mains charger, 100-240 V
 - PC connection cable
 - 3 round vials each 24 and 16 mm \varnothing
 - 1 adapter for 16 mm \varnothing vials
 - 3 syringes
 - 1 plastic beaker 100 ml
 - Warranty information
 - Certificate of Compliance
 - Instruction Manual
- but without reagents**

Order code: 21 00 00-B

Order code: 21 00 00 (without lithium battery)

Please specify the reagents or parameters required at time of order.

You can find updated information on parameters and measuring ranges on our website at www.lovibond.com

 **Please see pages 78 onwards for reagents (order codes)**

Technical Data

Display	Graphic-display
Optics	6 temperature compensating LED, internal reference channel, photodiode in protected sample chamber
Wavelengths	6 interference filters in one unit, $\lambda_1 = 430$ nm IF $\Delta \lambda$ (nm) = 5, $\lambda_2 = 530$ nm IF $\Delta \lambda$ (nm) = 5, $\lambda_3 = 560$ nm IF $\Delta \lambda$ (nm) = 5, $\lambda_4 = 580$ nm IF $\Delta \lambda$ (nm) = 5, $\lambda_5 = 610$ nm IF $\Delta \lambda$ (nm) = 6, $\lambda_6 = 660$ nm IF $\Delta \lambda$ (nm) = 5 IF = interference filter
Interface	RS232 for printer and PC-connection
Download	Software and methods update by means of the internet
Operation	Acid and solvent resistant, touch-sensitive keypad with audible feedback
Power Supply	7 Ni-MH-battery pack (AA/Mignon), charged whilst in the unit with external mains charger, integrated overload cut-out
Dimensions (L x W x H)	265 x 195 x 70 mm
Weight (unit)	approx. 1000 g with rechargeable batteries
Ambient Conditions	up to max. 90 % humidity (non condensing) approx. 5–40 °C
Auto-Off	approx. 20 minutes after last keypress with no loss of data
Auto-Check	By pressing ON/OFF-key
Memory Capacity	approx. 1000 data sets with date, time and registration number
Approval	CE

Dual Beam Technology

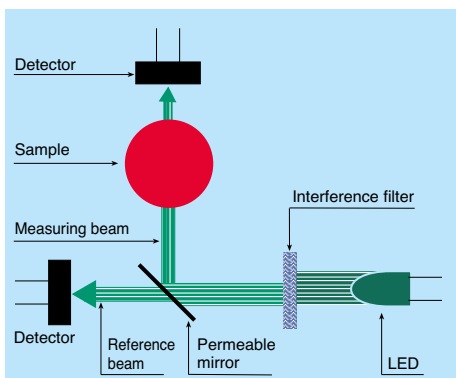

Verification Standard Kit

The verification standard kit for the MultiDirect is designed to assure the user of the accuracy and the reliability of the results. The shelf life of the verification standard kit is two years from the date of production, provided that storage and use are in accordance with the instructions provided.

Verification Standard Kit 21 56 50



Accessories

Item	Code	Item	Code
Set of 12 round vials with lid Height 48 mm, Ø 24 mm	19 76 20	Cleaning brush, 10 cm	38 02 30
Set of 10 round vials with lid Height 90 mm, Ø 16 mm	19 76 65	Syringe, plastic, 2 ml	36 90 80
Adapter for round vials Ø 16 mm	19 80 10 94	Syringe, plastic, 5 ml	36 61 20
Lid for adapter	19 80 11 00	Syringe, plastic, 10 ml	36 90 90
Vial stand for 6 round vials Ø 24 mm, acrylic glass	41 89 51	Rubber seal cap	19 80 15 01
Vial stand for 10 vials (Ø 16 mm or □ 13,5 mm), acrylic glass	41 89 57	Mains charger, 100-240 V, 50-60 Hz, with international adapters	19 30 10
Sealing ring for vial Ø 24 mm (12 pc.)	19 76 26	Universal adapter for socket, international	19 20 65
Cleaning cloth for vials	19 76 35	Cable for connection to PC, serial 9-pins	19 81 98
Adapter for Vacu-vial®	19 20 75	AA Ni-MH, 1100 mAh (7 pc.)	19 50 02 0
Plastic beaker, 100 ml	38 48 01	Lithium battery	19 50 01 7
Plastic funnel with handle	47 10 07	Paper printer DPN 2335	19 80 75
Plastic stirring rod, 13 cm length	36 41 00	Verification Standard Kit	21 56 50
Plastic stirring rod, 13 cm length, (10 pc.)	36 41 20		
Plastic stirring rod, 10 cm length	36 41 09		
Plastic stirring rod, 10 cm length, (10 pc.)	36 41 30		

Spectrophotometer SpectroDirect

For water and
waste water testing
330 - 900 nm

Highlights

- 330 to 900 nm
- Interface RS232
- Large illuminated display
- Touch-sensitive film keypad with logical layout
- Use of round vials and rectangular cells of different sizes without adapter
- 35 user-specific methods
- Fast, easy lamp change
- Update via Internet



The SpectroDirect is a modern single-beam spectrophotometer with an excellent price/performance ratio that is specifically designed for water testing.

The instrument is equipped with a wide range of pre-programmed methods based on the proven range of Lovibond® tube tests, tablet reagents, liquid reagents and powder reagents (Vario Powder Packs).

Optics

The SpectroDirect is a single-beam spectral photometer (see illustration).

The light source is a tungsten halogen lamp with flash function. The lamp is switched on only momentarily during of the measurement process¹⁾, so there is no need for a warm-up period. The SpectroDirect is ready to perform a self-test as soon as it is switched on.

The light passes through an entry slot to the monochromator, where it is split into spectral ranges. The monochromator is a holographically produced, transparent grating. The movable mirror ensures that light of the desired wavelength is focused automatically so that it passes through the exit slot, into the sample chamber and therefore through the water sample. The light that is not absorbed by the sample travels to the silicon photodiode detector. This signal is then evaluated by a microprocessor and shown as a result in the display.

1) (Exception: permanent light is used for a wavelength scan).

Multifunctional sample chamber

Round vials measuring 16 mm and 24 mm in diameter and rectangular cells with pathlengths from 10 to 50 mm may be used without an adapter. Only the 10 mm cell will be fixed by a little holder that must be inserted into the sample chamber.

New methods

Test methods are continuously updated to suit market requirements.

You can find updates for new methods and additional languages on our website at www.lovibond.com.

 Please see pages 78 onwards for reagents (order codes)

Functions

- Pre-programmed Lovibond® methods
- Absorption
- Transmission
- Spectral data recording
- User calibration (polynomials)
- Concentration (linear)
- Kinetics

Self-test

After it is switched on, the SpectroDirect automatically performs a self-test – beginning with a function test of the stepper motor and the halogen lamp, followed by an optics test. For this purpose, the unit has a built-in didymium glass filter. This filter checks the correct wavelength setting. If the wavelengths are incorrect, the optical system is automatically adjusted during the self-test.

Maintenance

Thanks to the design of the SpectroDirect, the only maintenance that is required is replacement of the light source. The lamp is situated at the back of the photometer in an easily accessible position. Changing the lamp is fast and simple and does not require any tools. The positioning of the assembly ensures optimum focusing of the halogen lamp.

Power supply

The required input voltage is 12 V. The SpectroDirect is connected to an external power pack as standard. Battery operation is also possible by using an external energy station (see accessories).

Choice of language

The user prompt in the display can be switched to German, English, French, Italian, Spanish or Portuguese. If further languages are available they can be updated via internet.

N.I.S.T. Traceability

This spectrophotometer can be tested using a Secondary Standard Filter Set (order code 711160) which is N.I.S.T. traceable. Furthermore the instrument may be calibrated for each method in a "user calibration mode" with N.I.S.T. traceable standards.

Applications

- Waste Water
- Drinking Water
- Industrial Process Water
- Science & Research
- Governmental and Private Laboratories





User prompt

The user prompt is a convenient and easy to understand feature that guides the user step by step all the way through to the test result.

Zero calibration and measurements

The user chooses the desired method either from the method list in alphabetical order or by entering a numerical code. If desired additional information like the required vial, the reagent type and the measuring range can be displayed using the functional keys. The date and time are shown in the display by pressing the "clock key". The SpectroDirect automatically selects the correct wavelength.

Zero calibration is performed with the water sample by pressing the ZERO key.

A characteristic coloration develops when you add the indicator to the water sample. Press the [Test] key to initiate the measurement (which starts either immediately or after the time required for colour development).

Countdown function

With some methods, after adding the indicator to the water sample, the user has to wait for a predefined colour reaction time. This time interval is shown in the display. The remaining time is displayed continuously. An alarm sounds during the last 10 seconds of the time period. Measurement then starts automatically, and the result is shown in the display. The countdown function can be switched off to allow rapid processing of a series of samples.

Differentiation of results

The SpectroDirect allows differentiated tests for certain methods. With the Chlorine method, for example, differentiated measurement is possible for free, combined and total chlorine.

Functions

The SpectroDirect is ideal for routine laboratory use and is equipped with additional functions for user-specific applications. One example is the creation of a user-defined method for a routine check.

Spectral data

A wavelength scan is performed over the user-defined interval between 330 and 900 nm.

The display shows the graph of the spectrum; if the user presses a key, the display also shows a data list with the corresponding maximum and minimum absorption levels.

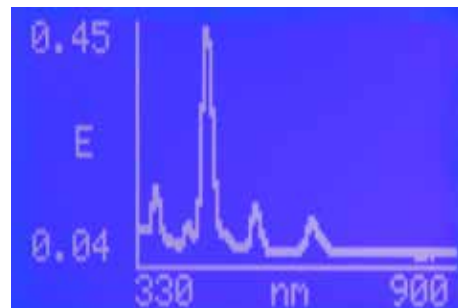

Printer/PC connection

On the back of the SpectroDirect photometer, there is an RS232 interface with a 9-pin D-Sub connector for connection of a PC or a printer with serial interface (see accessories).

Printing data

Every result is printed with date, time, reg. no, code no., measuring range and method number.

Storing data

You can store results of programmed and user-specific methods (polynomials) in a memory with a capacity of 1000 data sets. Alongside the result, the data sets contain information on method, date and time of the test.



Absorption/Transmission

Using this function, the operator can, for example, carry out measurement of standards with different concentrations using the user-selected wavelength in order to obtain the data pairs required for a polynomial. Result output is in Abs and % Transmission.

Polynomials

With the help of an external mathematical program, the corresponding polynomial is created from data pairs (concentration/absorption). A known polynomial may also be used. 25 order polynomials ($y = A+Bx+Cx^2 + Dx^3 + Ex^4 + Fx^5$) can be stored together with user-specific parameters such as wavelength, measuring range, unit and number of decimals.

Concentration

This function can be used to measure 2 to 14 known standards. On the basis of the concentrations/absorption pairs obtained, the photometer will calculate a linear interpolation between the measured points. Up to 10 methods can be stored for further sample measurements.

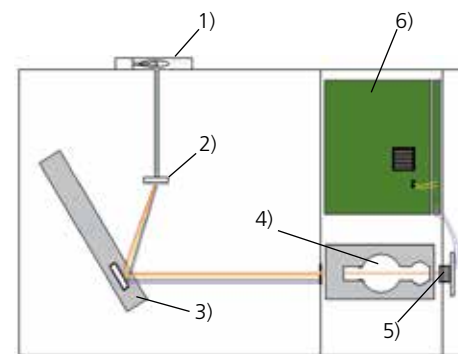

- 1) Tungsten halogen lamp
- 2) Monochromator
- 3) Movable mirror
- 4) Sample chamber
- 5) Silicon photodiode
- 6) Microprocessor unit

Technical data

Wavelength range:	330 to 900 nm
Photometric range:	-0.3 to 2.5 Abs
Spectral bandwidth:	10 nm
Wavelength accuracy:	± 2 nm
Wavelength reproducibility:	± 1 nm
Light source:	Pre-adjusted tungsten halogen lamp
Monochromator:	Holographic grating
Detector:	Silicon photodiode
Multifunctional sample chamber for:	Round vials 24 and 16 mm Ø, Rectangular cells 10 - 50 mm
Display:	Backlit LCD graphic display
Language options:	German, English, French, Italian, Spanish, Portugese
Storage capacity:	1000 test data sets
Serial interface:	RS232
Dimensions: (L x W x H)	270 x 275 x 150 mm
Weight:	approx. 3.2 kg
Power supply unit:	Input: 100 - 240 V ~ 1.0 A 50 - 60 Hz Output: 12 V 30 W

CE-Conformity



Accessories

Item	Code
Replacement halogen lamp	71 10 00
Magnetic pin (for updates)	19 80 16 87-2
Connection cable to a PC	19 81 97
Connection to a 12 V plug	71 10 40
Case for transport	71 20 50
Universal adapter for sockets	19 20 65
Secondary standard set	71 11 60
Plastic funnel with handle	47 10 07
Cleaning cloth for vials	19 76 35
Power supply unit 100-240 V / 50-60 Hz	71 10 90
Power station, 230 V / 50 Hz with cable for connection	71 10 50
12 round vials with lid Height 48 mm, 24 mm Ø	19 76 20
5 round vials with lid Height 48 mm, 24 mm Ø	19 76 29
10 round vials with lid Height 90 mm, 16 mm Ø	19 76 65
Vial stand for 6 round vials Ø 24 mm, acrylic glass	41 89 51
Vial stand for 10 vials (Ø 16 mm or □ 13,5 mm), acrylic glass	41 89 57
W 100, rectangular cell optical glass OG, 10 mm path length	60 10 40
W 100, rectangular cell optical glass OG, 50 mm path length	60 10 70
W 110, rectangular cell Quartz-UV-glass, 10 mm path length	66 11 30
Paper printer DPN 2335 with power pack (230 V, 50 Hz) connection cable and one paper roll	19 80 75
Arsenic glass apparatus	37 05 00
delivery content:	
Erlenmeyer flask	37 05 01
Glass stopper	37 05 02
Absorption tube	37 05 03

additionally required (**not** included, please order separately):

W 100, cell, Optical-Glass-OG, 20 mm path length	60 10 50
---	----------

Delivery Content

SpectroDirect (standard equipment)

- SpectroDirect (basic unit)
- Power supply unit 100 - 240 V
- Serial cable for connection to a PC
- Magnetic pin
- 2 batteries (AA)
- Manufacturers test certificate M
- Warranty information
- Instruction manual

Order code: 71 20 00

SpectroDirect (advanced features)

- SpectroDirect in aluminium case
- Power supply unit 100 - 240 V
- Serial cable for connection to a PC
- Magnetic pin
- 2 batteries (AA)
- Energy station
- Replacement lamp
- 12 round vials with lids, 24 mm Ø
- 10 round vials with lids, 16 mm Ø
- 2 rectangular cells, 10 mm path length
- 2 rectangular cells, 50 mm path length
- Plastic stirring rod, 13 cm
- Manufacturers test certificate M
- Warranty information
- Instruction manual

Order code: 71 20 05

We would be pleased to quote a ready to use spectrophotometer unit for the parameters and required accessories.

➔ **Please see pages 78 onwards for reagents (order codes)**

Reagents

Development

For several decades, Tintometer has been manufacturing reagents for water testing and marketing these reagents around the world under the brand name Lovibond®.

Different forms of reagents are required for different fields of application. It is fair to say that, in terms of quality, tablet reagents are the best form of reagent. Thanks to production techniques of the type used in the pharmaceutical industry and stringent internal quality standards, Tintometer is able to produce tablet reagents for water testing with a guaranteed shelf life of 5 or 10 years. These tablets are individually sealed in high-grade, polyethylene-coated aluminium foil and represent the reagent form of choice for everyday water testing applications.

Users in different countries traditionally prefer forms of reagent other than tablets. Lovibond® powder reagents are designed to allow fast and easy testing.

Powder reagents are packed in aluminium for a wide range of applications and represent an alternative reagent form recently introduced by Tintometer.

Last but not least, liquid reagents are indispensable for many testing tasks. Testing for substances that are hard to detect, for parameters like total nitrogen, or for the aggregate parameter COD, require the use of a wide range of reagents in a form that permits more "aggressive" sample processing. The Lovibond® programme is rounded off by reagent tests and tube tests, making Tintometer the only reagent producer in the world that offers a complete range of reagent forms.

Tablet reagents

Our test tablets are manufactured in Germany under tightly controlled conditions on most modern machinery.

Maintaining the highest quality standards permits Tintometer to guarantee our tablet reagents for a minimum of 5 years, and some for as long as 10 years.

We can make this promise because each tablet is hermetically sealed within an individual aluminium foil pocket, protecting against challenging environmental conditions. This packaging keeps each tablet in perfect condition, right up until the time it is needed by the user.

Test tablets remain the most consistent and reliable reagent format available, consistently outperforming other reagent formats, and delivering maximum accuracy for the user.

The aluminium foil blister packaging brings added convenience to the tradition of protection achieved in the Lovibond® long established tablet production technology.

With the blister strip, the user just pushes the tablet through the protective foil, straight into the sample. Simple, time-saving and practical.

This type of packaging, long established in pharmaceutical applications, combines all the advantages of protective foil, with convenience for the user.

There are no safety risks if the tablets are used in line with the instructions supplied. Safety data sheets are available for all reagents.

Specifications and Certificate of Analysis

To express the high quality standard of Lovibond® tablet reagents, specifications for each type of tablet as well as a "Certificate of Analysis" for each lot is available in the down-load area at www.lovibond.com.

Tube tests

Lovibond® tube tests enable the user to easily perform highly sensitive and precise water testing.

When using tube tests measurement is considerably faster and easier, particularly in the case of standard and serial tests.

The tube tests contain a precisely measured amount of reagent, thereby avoiding the presence of superfluous chemicals and optimising test safety.

Up to six different measuring ranges are available for the various tests.

The tubes are made of special optical glass with a 16 mm in diameter. They are supplied in a storage and dispatch box together with the digestion or auxiliary reagents. This packaging unit contains 24 or 25 reaction vials and up to 2 zero vials for photometer system calibration.



Liquid reagents

As a rule, liquid reagents do not consist of a single preparation but comprise several components that need to be added to the sample in a certain order. As both the size and the number of drops have a decisive effect on the resultant colour complex, the reagents need to be added with a high degree of precision.

The shelf life of liquid reagents is reduced by temporary contact with oxygen in the air when the bottle is opened as well as by unsuitable storage environments (presence of sunlight or high temperatures). Provided that the bottles are stored within the temperature range +6°C to +10°C, the Lovibond® DPD and Phenol Red solutions can be used for a period of two years from the production date.

VARIO Powder Packs

The fast and easy use of VARIO Powder Packs has made them extremely popular for water testing applications in many countries throughout the world.

The Lovibond® Powder Pack programme provides users with a real alternative to existing measurement systems.

The Vario Powder Packs are produced to the same high quality standards that have made Tintometer's tablet reagents so successful for several decades.

Parameters from aluminium and chlorine through to sulphate are just some of the well-known tests that are included in the VARIO Powder Pack range.

Their chemical properties make them compatible to Hach® devices.*

➔ Detailed information see pages 100 - 107



Membrane filter set

For use when preparing samples for photometric measurements

Advantages

- removes turbid materials from samples
- differentiates between dissolved and total substances
- 0.45 µm mesh meets the requirements of the official German unitary procedure for water testing

To prevent the effects of light scatter, it must be ensured that all turbid materials are removed from the sample before photometric measurements are carried out. This can be achieved with the Lovibond® membrane filter set.

Where certain methods are employed (e.g., iron, manganese, CSB, etc.) a membrane filter set must be used to differentiate samples in terms of dissolved and total substances. The filter mesh size of 0.45 µm is in accordance with the official German unitary procedure for water testing.

Order code: 36 61 50
(covers 25 x 0.45 µm membrane filters and two 20 ml syringes)



* HACH® is a registered trademark of Hach Company, Loveland, Colorado. The use of the HACH® trademark does not imply any affiliation with or approval by Hach Company regarding the formulation, testing or compatibility of these products for use in HACH® brand spectrophotometers or other devices or systems.

Reagents

Test	Range	Wave lengths λ / nm							Method	Cuvette
		MD 100	MD 200	MD 600 & MD 610	MultiDirect	PM 620 & PM 630	PM 600	SpectroDirect		
Alkalinity-M	5 - 200 mg/l	610	610	610	610	610	610	615	Acid/Indicator ^{1,2,5}	24 mm \emptyset
Alkalinity-M HR	5 - 500 mg/l	-	-	610	610	610	610	615	Acid/Indicator ^{1,2,5}	24 mm \emptyset
Alkalinity-P	5 - 300 mg/l	-	-	560	560	-	-	551	Acid/Indicator ^{1,2,5}	24 mm \emptyset
Aluminium VARIO	0.01 - 0.25 mg/l	530	-	530	530	530	-	535	Eriochrome cyanine R ²	24 mm \emptyset
Aluminium	0.01 - 0.3 mg/l	530	-	530	530	530	-	535	Eriochrome cyanine R ²	24 mm \emptyset
Ammonia	0.02 - 1 mg/l	610	-	610	610	610	-	676	Indophenole blue ^{2,3}	24 mm \emptyset
Ammonia VARIO	0.01 - 0.8 mg/l	660	-	660	660	-	-	655	Salicylate ²	24 mm \emptyset
Ammonia VARIO LR	0.02 - 2.5 mg/l	-	-	660	660	-	-	655	Salicylate ²	16 mm \emptyset
Ammonia VARIO HR	1 - 50 mg/l	-	-	660	660	-	-	655	Salicylate ²	16 mm \emptyset
Arsenic (III, V)	0.02 - 0.6 mg/l	-	-	-	-	-	-	507	Silver diethyldithiocarbamate ¹	20 mm \square

MSDS (Material Safety Data Sheets): www.lovibond.com

For other reagent quantities please see our current price list.

Legend

¹ Deutsche Einheitsverfahren zur Wasser-, Abwasser- und Schlamm- Untersuchung

² Standard Methods for the Examination of Water and Wastewater, 18th Edition; 1992

³ Photometrische Analysenverfahren, Schwedt, Wissenschaftliche Verlagsgesellschaft mbH, Stuttgart; 1989

⁴ Photometrische Analyse, Lange/Vejdelek, Verlag Chemie; 1980

⁵ Colorimetric Chemical Analytical Methods, 9th Edition, Lovibond®

Display	Reagent	Form of reagent/Quantity	Order code
CaCO ₃	ALKA-M-PHOTOMETER	Tablet / 100	51 32 10 BT
CaCO ₃	ALKA-M-HR-PHOTOMETER	Tablet / 100	51 32 40 BT
CaCO ₃	ALKA-P-PHOTOMETER	Tablet / 100	51 32 30 BT
Al	VARIO Aluminum ECR/F20 VARIO Aluminum Hexamine/F20 VARIO Aluminum ECR Masking Reagent	Powder Pack / 100 Powder Pack / 100 Liquid reagent / 25 ml Set	53 50 00
Al	ALUMINIUM No. 1 ALUMINIUM No. 2 Combi pack# ALUMINIUM No.1 / No.2 Combi pack# ALUMINIUM No.1 / No.2	Tablet / 100 Tablet / 100 each 100 each 250	51 54 60 BT 51 54 70 BT 51 76 01 BT 51 76 02 BT
N	AMMONIA No. 1 AMMONIA No. 2 Combi pack# AMMONIA No.1 / No.2 Combi pack# AMMONIA No.1 / No.2 Ammonia conditioning powder (for seawater)	Tablet / 100 Tablet / 100 each 100 each 250 Powder / 15 g / 50 Tests	51 25 80 BT 51 25 90 BT 51 76 11 BT 51 76 12 BT 46 01 70
N	VARIO Ammonia Salicylate F10 VARIO Ammonia Cyanurate F10	Powder Pack / 100 Powder Pack / 100 Set	53 55 00
N	VARIO Ammonia Salicylate F5 VARIO Ammonia Cyanurate F5 VARIO Am Diluent Reagent LR VARIO Deionised Water (for Zero)	Powder Pack / 50 Powder Pack / 50 Reaction tube / 50 Bottle, 100 ml Set (Tube test)	53 56 00
N	VARIO Ammonia Salicylate F5 VARIO Ammonia Cyanurate F5 VARIO Am Diluent Reagent HR VARIO Deionised Water (for Zero)	Powder Pack / 50 Powder Pack / 50 Reaction tube / 50 Bottle, 100 ml Set (Tube test)	53 56 50
As	for chemicals see manual, reagents at specialized chemistry dealer		

a) determination of free, combined and total

b) Thermoreactor is necessary for COD (150 °C), TOC (120 °C) and total -chromium, - phosphate, -nitrogen, (100 °C)

c) MultiDirect: Adapter is necessary for Vacu-vials® (Order code 19 20 75)

d) Spectroquant® is a Merck KGaA Trademark

e) alternative reagent, used instead of DPD No.1 / DPD No.3 in case of turbidity in the water sample caused by high concentration of calcium and/or high conductivity

f) additionally required for determination of bromine, chlorine dioxide and ozone in the presence of chlorine

g) Reagent recovers most insoluble iron oxides without digestion

h) additionally required for samples with hardness values above 300 mg/l CaCO₃

i) high range by dilution

j) Vacu-vials® is a Chemetrics Trademark

including stirring rod

Reagents

Test	Range	Wave lengths λ / nm							Method	Cuvette
		MD 100	MD 200	MD 600 & MD 610	MultiDirect	PM 620 & PM 630	PM 600	SpectroDirect		
Biguanide (see PHMB)										
Boron	0.1 - 2 mg/l	-	-	430	430	-	-	450	Azomethine ³	24 mm \emptyset
Bromine	0.05 - 13 mg/l	530	530	530	530	530	530	-	DPD ⁵	24 mm \emptyset 50 mm \square 10 mm \square 24 mm \emptyset
	0.05 - 1 mg/l	-	-	-	-	-	-	510		
	0.1 - 3 mg/l	-	-	-	-	-	-	510		
	0.05 - 6.5 mg/l	-	-	-	-	-	-	510		
Bromine VARIO	0.05 - 4.5 mg/l	-	-	530	530	-	-	-	DPD ^{1,2}	24 mm \emptyset
Cadmium (Cd²⁺)	0.025 - 0.75 mg/l	-	-	-	-	-	-	525	Cadion	16 mm \emptyset
Chloride	0.5 - 25 mg/l	530	-	530	530	-	-	450	Silver nitrate/turbidity	24 mm \emptyset
	5 - 250 mg/l ¹⁾	530	-	-	-	-	-	-		
Chloride	5 - 60 mg/l	-	-	-	-	-	-	455	Iron (III)-thiocyanate ⁴	24 mm \emptyset
Chloride	0.5 - 20 mg/l	430	-	430	-	-	-	-	Mercury thiocyanate / Iron nitrate	24 mm \emptyset
Chlorine ^{a)}	0.01 - 6 mg/l	530	530	530	530	530	530	-	DPD ^{1,2}	24 mm \emptyset 50 mm \square 10 mm \square 24 mm \emptyset
	0.02 - 0.5 mg/l	-	-	-	-	-	-	510		
	0.1 - 6 mg/l	-	-	-	-	-	-	510		
	0.02 - 3 mg/l	-	-	-	-	-	-	510		
Chlorine HR (DPD) ^{a)}	0.1 - 10 mg/l	530	530	530	530	530	530	510	DPD ^{1,2}	24 mm \emptyset

MSDS (Material Safety Data Sheets): www.lovibond.com

For other reagent quantities please see our current price list.

Legend

¹ Deutsche Einheitsverfahren zur Wasser-, Abwasser- und Schlamm- Untersuchung

² Standard Methods for the Examination of Water and Wastewater, 18th Edition; 1992

³ Photometrische Analysenverfahren, Schwedt, Wissenschaftliche Verlagsgesellschaft mbH, Stuttgart; 1989

⁴ Photometrische Analyse, Lange/Vejdelek, Verlag Chemie; 1980

⁵ Colorimetric Chemical Analytical Methods, 9th Edition, Lovibond®

Display	Reagent	Form of reagent/Quantity	Order code
B	BORON No. 1 BORON No. 2 Combi pack# BORON No.1 / No.2 Combi pack# BORON No.1 / No.2	Tablet / 100 Tablet / 100 each 100 each 200	51 57 90 51 58 00BT 51 76 81BT 51 76 82BT
Br	DPD No. 1 DPD No. 3 Combi Pack# DPD No.1 / No.3 Combi Pack# DPD No.1 / No.3 DPD No. 1 HIGH CALCIUM ^{e)} DPD No. 3 HIGH CALCIUM ^{e)} Combi Pack# DPD No.1 / No.3 HIGH CALCIUM ^{e)} Combi Pack# DPD No.1 / No.3 HIGH CALCIUM ^{e)} DPD Nitrite GLYCINE ^{f)} Combi pack# DPD No.1 / GLYCINE Combi pack# DPD No.1 / GLYCINE	Tablet / 100 Tablet / 100 each 100 each 250 Tablet / 100 Tablet / 100 each 100 each 250 Tablet / 100 Tablet / 100 each 100 each 250	51 10 50 BT 51 10 80 BT 51 77 11 BT 51 77 12 BT 51 57 40 BT 51 57 30 BT 51 77 81 BT 51 77 82 BT 50 26 91 51 21 70 BT 51 77 31 BT 51 77 32 BT
Br	VARIO Chlorine TOTAL-DPD/F10	Powder Pack / 100	53 01 20
Cd	Spectroquant® 1.14834.0001 ^{d)}	Tube test / 25	42 07 50
Cl	CHLORIDE T1 CHLORIDE T2 Combi pack# CHLORIDE T1 / T2 Combi pack# CHLORIDE T1 / T2	Tablet / 100 Tablet / 100 each 100 each 250	51 59 10 BT 51 59 20 BT 51 77 41 BT 51 77 42 BT
Cl	Chlorid-51 / Chlorid-52	Reagent test (Liquid reagent) approx. 50-75 Tests	2 41 90 31
Cl ⁻	KS251 (Chloride Reagent A) KS253 (Chloride Reagent B)	Liquid reagent / 65 ml Liquid reagent / 65 ml Set	56L025165 56L025365 56R018490
Cl ₂	DPD No. 1 DPD No. 3 Combi pack# DPD No.1 / No.3 Combi pack# DPD No.1 / No.3 DPD No. 1 HIGH CALCIUM ^{e)} DPD No. 3 HIGH CALCIUM ^{e)} Combi Pack# DPD No.1 / No.3 HIGH CALCIUM ^{e)} Combi Pack# DPD No.1 / No.3 HIGH CALCIUM ^{e)}	Tablet / 100 Tablet / 100 each 100 each 250 Tablet / 100 Tablet / 100 each 100 each 250	51 10 50 BT 51 10 80 BT 51 77 11 BT 51 77 12 BT 51 57 40 BT 51 57 30 BT 51 77 81 BT 51 77 82 BT
Cl ₂	DPD No. 1 HR DPD No. 3 HR	Tablet / 100 Tablet / 100	51 15 00 BT 51 15 90 BT

^{a)} determination of free, combined and total

^{b)} Thermoreactor is necessary for COD (150 °C), TOC (120 °C) and total -chromium, - phosphate, -nitrogen, (100 °C)

^{c)} MultiDirect: Adapter is necessary for Vacu-vials® (Order code 19 20 75)

^{d)} Spectroquant® is a Merck KGaA Trademark

^{e)} alternative reagent, used instead of DPD No.1 / DPD No.3 in case of turbidity in the water sample caused by high concentration of calcium and/or high conductivity additionally required for determination of bromine, chlorine dioxide and ozone in the presence of chlorine

^{g)} Reagent recovers most insoluble iron oxides without digestion

^{h)} additionally required for samples with hardness values above 300 mg/l CaCO₃

ⁱ⁾ high range by dilution

^{j)} Vacu-vials® is a Chemetrics Trademark

including stirring rod

Reagents

Test	Range	Wave lengths λ / nm							Method	Cuvette
		MD 100	MD 200	MD 600 & MD 610	MultiDirect	PM 620 & PM 630	PM 600	SpectroDirect		
Chlorine ^{a)}	0.02 - 4 mg/l 0.02 - 3 mg/l	530 -	530 -	530 -	530 -	530 -	- -	- 510	DPD ^{1,2}	24 mm \emptyset 24 mm \emptyset
Chlorine VARIO ^{a)}	0.02 - 2 mg/l 0.1 - 8 mg/l	530 530	- -	530 530	530 -	530 530	- -	510 -	DPD ^{1,2}	24 mm \emptyset 24 mm \emptyset multy vial
Chlorine HR (KI)	5 - 200 mg/l	530	-	530	530	-	-	470	KI / Acid ⁵	16 mm \emptyset
Chlorine dioxide	0.02 - 11 mg/l 0.05 - 1 mg/l 0.05 - 2.5 mg/l	530 - -	530 - -	530 - -	530 - -	530 - -	- - -	- 510 510	DPD/Glycine ^{1,2}	24 mm \emptyset 50 mm \square 24 mm \emptyset
Chlorine dioxide VARIO	0.04 - 3.8 mg/l	530	-	530	530	-	-	-	DPD ^{1,2}	24 mm \emptyset
Chromium (III, VI) ^{b)}	0.005 - 0.5 mg/l 0.02 - 2 mg/l	- -	- -	- 530	- -	- -	- -	542 542	1,5-Diphenylcarbozide ^{1,2}	50 mm \square 16 mm \emptyset
COD LR (ISO 15705:2002) ^{b)}	0 - 150 mg/l	430	430	430	430	-	-	420	Dichromate / H ₂ SO ₄ ^{1,2}	16 mm \emptyset
COD MR (ISO 15705:2002) ^{b)}	0 - 1500 mg/l	610	610	610	610	-	-	620	Dichromate / H ₂ SO ₄ ^{1,2}	16 mm \emptyset
COD HR ^{b)}	0 - 15000 mg/l	610	610	610	610	-	-	620	Dichromate / H ₂ SO ₄ ^{1,2}	16 mm \emptyset
Copper ^{a)}	0.05 - 5 mg/l 0.05 - 1 mg/l 0.3 - 5 mg/l 0.5 - 5 mg/l	560 - 530 -	560 - - -	560 - - -	560 - - -	560 - - -	560 - - -	- 559 - 559	Biquinoline ⁴	24 mm \emptyset 50 mm \emptyset 24 mm \emptyset 24 mm \emptyset

MSDS (Material Safety Data Sheets): www.lovibond.com

For other reagent quantities please see our current price list.

Legend

¹ Deutsche Einheitsverfahren zur Wasser-, Abwasser- und Schlamm- Untersuchung

² Standard Methods for the Examination of Water and Wastewater, 18th Edition; 1992

³ Photometrische Analysenverfahren, Schwedt, Wissenschaftliche Verlagsgesellschaft mbH, Stuttgart; 1989

⁴ Photometrische Analyse, Lange/Vejdelek, Verlag Chemie; 1980

⁵ Colorimetric Chemical Analytical Methods, 9th Edition, Lovibond®

Display	Reagent	Form of reagent/Quantity	Order code
Cl ₂	DPD 1 Buffer solution	Liquid reagent / 15 ml	47 10 10
	DPD 1 Reagent solution	Liquid reagent / 15 ml	47 10 20
	DPD 3 Solution	Liquid reagent / 15 ml	47 10 30
		Set	47 10 56
Cl ₂	VARIO Chlorine FREE-DPD/F10	Powder Pack / 100	53 01 00
	VARIO Chlorine TOTAL-DPD/F10	Powder Pack / 100	53 01 20
Cl ₂	ACIDIFYING GP	Tablet / 100	51 54 80 BT
	CHLORINE HR (KI)	Tablet / 100	51 30 00 BT
	Combi pack# CHLORINE HR (KI)/ACIDIFYING GP	each 100	51 77 21 BT
	Combi pack# CHLORINE HR (KI)/ACIDIFYING GP	each 250	51 77 22 BT
ClO ₂	DPD No. 1	Tablet / 100	51 10 50 BT
	DPD No. 3	Tablet / 100	51 10 80 BT
	Combi pack# DPD No.1 / No.3	each 100	51 77 11 BT
	Combi pack# DPD No.1 / No.3	each 250	51 77 12 BT
	GLYCINE ^{f)}	Tablet / 100	51 21 70 BT
	Combi pack# DPD No.1 / GLYCINE	each 100	51 77 31 BT
	Combi pack# DPD No.1 / GLYCINE	each 250	51 77 32 BT
	DPD No. 1 HIGH CALCIUM ^{e)}	Tablet / 100	51 57 40 BT
	DPD No. 3 HIGH CALCIUM ^{e)}	Tablet / 100	51 57 30 BT
	Combi Pack# DPD No.1 / No.3 HIGH CALCIUM ^{e)}	each 100	51 77 81 BT
Combi Pack# DPD No.1 / No.3 HIGH CALCIUM ^{e)}	each 250	51 77 82 BT	
ClO ₂	VARIO Chlorine FREE-DPD/F10	Powder Pack / 100	53 01 00
	GLYCINE ^{f)}	Tablet / 100	51 21 70 BT
Cr	PERSULF. RTG FOR CR	Powder Pack / 100	53 73 00
	Chromium Hexavalent	Powder Pack /100	53 73 10
O ₂	Reaction tube 0-150 mg/l	Tube test / 25	2 42 07 20
	Reaction tube 0-150 mg/l, mercury free* *without chloride removal	Tube test / 25	2 42 07 10
O ₂	Reaction tube 0-1500 mg/l	Tube test / 25	2 42 07 21
	Reaction tube 0-1500 mg/l, mercury free* *without chloride removal	Tube test / 25	2 42 07 11
O ₂	Reaction tube 0-15000 mg/l	Tube test / 25	2 42 07 22
	Reaction tube 0-15000 mg/l, mercury free* *without chloride removal	Tube test / 25	2 42 07 12
Cu	COPPER No. 1	Tablet / 100	51 35 50 BT
	COPPER No. 2	Tablet / 100	51 35 60 BT
	Combi pack# COPPER No.1 / No.2	each 100	51 76 91 BT
	Combi pack# COPPER No.1 / No.2	each 250	51 76 92 BT

^{a)} determination of free, combined and total

^{b)} Thermoreactor is necessary for COD (150 °C), TOC (120 °C) and total -chromium, - phosphate, -nitrogen, (100 °C)

^{c)} MultiDirect: Adapter is necessary for Vacu-vials® (Order code 19 20 75)

^{d)} Spectroquant® is a Merck KGaA Trademark

^{e)} alternative reagent, used instead of DPD No.1 / DPD No.3 in case of turbidity in the water sample caused by high concentration of calcium and/or high conductivity additionally required for determination of bromine, chlorine dioxide and ozone in the presence of chlorine

^{g)} Reagent recovers most insoluble iron oxides without digestion

^{h)} additionally required for samples with hardness values above 300 mg/l CaCO₃

ⁱ⁾ high range by dilution

^{j)} Vacu-vials® is a Chemetrics Trademark

including stirring rod

Reagents

Test	Range	Wave lengths λ / nm							Method	Cuvette
		MD 100	MD 200	MD 600 & MD 610	MultiDirect	PM 620 & PM 630	PM 600	SpectroDirect		
Copper ^{a)}	0.05 - 4 mg/l	-	-	560	-	-	-	-	Bicinchoninate	24 mm \emptyset
Copper, free VARIO	0.05 - 5 mg/l	560	-	560	560	560	-	560	Bicinchoninate	24 mm \emptyset
Cyanide	0.01 - 0.5 mg/l 0.005 - 0.2 mg/l	-	-	580	580	-	-	585 585	Pyridine-barbituric acid ¹	24 mm \emptyset 50 mm \square
Cyanuric acid	0 - 160 mg/l	530	530	530	530	530	530	530	Melamine	24 mm \emptyset
DEHA	20 - 500 μ g/l	-	-	560	560	-	-	562	PPST ³	24 mm \emptyset
DEHA VARIO	20 - 500 μ g/l	560	-	560	560	-	-	562	PPST ³	24 mm \emptyset
Fluoride	0.05 - 2 mg/l 0.05 - 1.5 mg/l	580 -	- -	580 -	580 -	- -	- -	- 580	SPADNS ²	24 mm \emptyset
Formaldehyde	1 - 5 mg/l 0.02 - 1 mg/l	- -	- -	- -	- -	- -	- -	585 585	H ₂ SO ₄ / Chromotropic acid	10 mm \square 50 mm \square
Formaldehyde	0.1 - 5 mg/l	-	-	-	-	-	-	575	H ₂ SO ₄ / Chromotropic acid	16 mm \emptyset
Hardness, calcium	50 - 900 mg/l	-	-	560	560	-	-	-	Murexide ⁴	24 mm \emptyset
Hardness, calcium	0 - 500 mg/l	560	560	560	560	560	560	-	Murexide ⁴	24 mm \emptyset
Hardness, total	2 - 50 mg/l 20 - 500 mg/l ^{b)}	560 560	- -	560 560	560 560	560 560	- -	571 571	Metallphthalein ³	24 mm \emptyset
Hazen (Pt-Co-units ; APHA)	0 - 500 mg/l 0 - 500 mg/l	430 -	- -	430 -	430 -	- -	- -	- 455	Direct reading ^{1,2}	24 mm \emptyset 50 mm \square
Hydrazine	0.05 - 0.5 mg/l	430	-	430	430	-	-	455	Dimethylamino- benzaldehyde ³	24 mm \emptyset

MSDS (Material Safety Data Sheets): www.lovibond.com

For other reagent quantities please see our current price list.

Legend

¹ Deutsche Einheitsverfahren zur Wasser-, Abwasser- und Schlamm- Untersuchung

² Standard Methods for the Examination of Water and Wastewater, 18th Edition; 1992

³ Photometrische Analysenverfahren, Schwedt, Wissenschaftliche Verlagsgesellschaft mbH, Stuttgart; 1989

⁴ Photometrische Analyse, Lange/Vejdelek, Verlag Chemie; 1980

⁵ Colorimetric Chemical Analytical Methods, 9th Edition, Lovibond®

Display	Reagent	Form of reagent/Quantity	Order code
Cu	KS240 (Coppercol Reagent 1) KS241 (Coppercol Reagent 2) KS242 (Coppercol Reagent 3) COPPER No.2	Liquid reagent / 30 ml Liquid reagent / 30 ml Powder / 10 g Tablet / 100 Set	56L024030 56L024130 56L024210 51 35 60 BT 56R023355
Cu	Vario Cu 1 F10	Powder Pack / 100	53 03 00
CN	Cyanid-11 / Cyanid-12 / Cyanid-13	Reagent test (Powder, Liquid reagent) / 200 Tests	2 41 88 75
Cys	CyA-TEST	Tablet / 100	51 13 70 BT
DEHA	DEHA Solution DEHA	Liquid reagent / 100 ml Tablet / 100	46 11 81 51 32 20 BT
DEHA	VARIO OXYSCAV 1 RGT VARIO DEHA 2 RGT	Powder Pack / 200 Solution / 100 ml Set	53 60 00
F	SPADNS Reagent Fluoride Standard Reagent solution and standard required	Liquid reagent / 250 ml Liquid reagent / 500 ml Solution / 30 ml	46 74 81 46 74 82 20 56 30
HCHO	Spectroquant® 1.14678.0001 ^{d)}	Reagent test / ca. 50-75 Tests	42 07 51
HCHO	Spectroquant® 1.14500.0001 ^{d)}	Tube test / 25	42 07 52
CaCO ₃	CALCHECK	Tablet / 100	51 56 50 BT
CaCO ₃	Combi pack# CALCIO H No.1 / No.2 Combi pack# CALCIO H No.1 / No.2	each 100 each 250	51 77 61 BT 51 77 62 BT
CaCO ₃	HARDCHECK P	Tablet / 100 Tablet / 250	51 56 60 BT 51 56 61 BT
Pt-Co-units	no reagents required	-	-
N ₂ H ₄	Hydrazine Test Powder Spoon	Powder / 30 g	46 29 10 38 49 30

^{a)} determination of free, combined and total

^{b)} Thermoreactor is necessary for COD (150 °C), TOC (120 °C) and total -chromium, - phosphate, -nitrogen, (100 °C)

^{c)} MultiDirect: Adapter is necessary for Vacu-vials® (Order code 19 20 75)

^{d)} Spectroquant® is a Merck KGaA Trademark

^{e)} alternative reagent, used instead of DPD No.1 / DPD No.3 in case of turbidity in the water sample caused by high concentration of calcium and/or high conductivity additionally required for determination of bromine, chlorine dioxide and ozone in the presence of chlorine

^{g)} Reagent recovers most insoluble iron oxides without digestion

^{h)} additionally required for samples with hardness values above 300 mg/l CaCO₃

ⁱ⁾ high range by dilution

^{j)} Vacu-vials® is a Chemetrics Trademark

including stirring rod

Reagents

Test	Range	Wave lengths λ / nm							Method	Cuvette	
		MD 100	MD 200	MD 600 & MD 610	MultiDirect	PM 620 & PM 630	PM 600	SpectroDirect			
Hydrazine	0.01 - 0.6 mg/l 0.005 - 0.6 mg/l	-	-	430	430	-	-	-	455	Dimethylamino-benzaldehyde ³	24 mm \emptyset
Hydrazine ¹⁾	0.01 - 0.7 mg/l	-	-	430	430	-	-	-	-	PDMAB	24 mm \emptyset
Hydrogen peroxide	0.03 - 3 mg/l 0.01 - 0.5 mg/l 0.03 - 1.5 mg/l	-	-	530	530	530	-	-	510 510	DPD/Catalyst ⁵	24 mm \emptyset 50 mm \square 24 mm \emptyset
Hydrogen peroxide	1 - 50 mg/l 40 - 500 mg/l ¹⁾	-	430 530	430 530	430 530	- 530	-	-	-	Peroxotitanium acid	24 mm \emptyset
Iodine	0.05 - 3.6 mg/l	-	-	530	530	530	-	-	510	DPD ⁵	24 mm \emptyset
Iron (II, III) soluble	0.02 - 1 mg/l 0.01 - 0.5 mg/l 0.1 - 1 mg/l	560 -	560 -	560 -	560 -	560 -	560 -	-	562 562	PPST ³	24 mm \emptyset 50 mm \square 10 mm \square
Iron VARIO (II, III) soluble	0.02 - 3 mg/l 0.1 - 3 mg/l	530 -	-	530 -	530 -	-	-	-	510	1,10-Phenanthroline ²	24 mm \emptyset
Iron VARIO, total ⁹⁾	0.02 - 1.8 mg/l 0.1 - 1.8 mg/l	580 -	-	580 -	580 -	-	-	-	590	TPTZ ⁹⁾	24 mm \emptyset
Iron LR (Fe ^{2+/3+})	0.03 - 2.0 mg/l 0.03 - 2.0 mg/l	560 530	-	560	-	-	-	-	-	Ferrozine / Thioglycolate	24 mm \emptyset
Iron LR 2 (Fe ²⁺ and Fe ³⁺)	0.03 - 2.0 mg/l	-	-	560	-	-	-	-	-	Ferrozine / Thioglycolate	24 mm \emptyset
Iron HR	0.1 - 10 mg/l	-	-	530	-	-	-	-	-	Thioglycolate	24 mm \emptyset
Iron, total, Fe in Mo	0.01 - 1.8 mg/l	580	-	580	-	-	-	-	-	Fe in Mo	24 mm \emptyset

MSDS (Material Safety Data Sheets): www.lovibond.com

For other reagent quantities please see our current price list.

Legend

¹ Deutsche Einheitsverfahren zur Wasser-, Abwasser- und Schlamm- Untersuchung

² Standard Methods for the Examination of Water and Wastewater, 18th Edition; 1992

³ Photometrische Analysenverfahren, Schwedt, Wissenschaftliche Verlagsgesellschaft mbH, Stuttgart; 1989

⁴ Photometrische Analyse, Lange/Vejdelek, Verlag Chemie; 1980

⁵ Colorimetric Chemical Analytical Methods, 9th Edition, Lovibond®

Display	Reagent	Form of reagent/Quantity	Order code
N ₂ H ₄	VARIO Hydra 2 Rgt Solution	Solution / 100 ml	53 12 00
N ₂ H ₄	Vacu-vial [®] ^{j)}	Test Kit / 30 Adapter for Vacu-vials [®] ^{j)}	38 04 70 19 20 75
H ₂ O ₂	HYDROGENPEROXIDE LR	Tablet / 100	51 23 80 BT
H ₂ O ₂	H ₂ O ₂ reagent solution	Liquid reagent / 15 ml	42 49 91
I	DPD No. 1	Tablet / 100	51 10 50 BT
Fe	IRON LR (Fe ²⁺ and Fe ³⁺) IRON (II) LR (Fe ²⁺)	Tablet / 100 Tablet / 100	51 53 70 BT 51 54 20 BT
Fe	VARIO Ferro F10	Powder Pack / 100	53 05 60
Fe	VARIO IRON TPTZ F10	Powder Pack / 100	53 05 50
Fe	KS61 (Ferrozine / Thioglycolate, FE5) KS63 (Thioglycolate Reagenz, FE6) KP962 (Ammonia Persulphate Powder) KS135 (Phenolphthalein / Indicator) KS144 (Calcium Hardness Buffer)	Liquid reagent / 65 ml Liquid reagent / 65 ml Powder Liquid reagent / 65 ml Liquid reagent / 65 ml	56L006165 56L006365 56P096240 56L013565 56L014465
Fe	KS60 FE1 (Acetate Buffer) KS63 FE6 (Thioglycolate Reagent) KS65 FE7 (Ferrozine Reagent)	Liquid reagent / 65 ml Liquid reagent / 65 ml Liquid reagent / 65 ml Set	56L006065 56L006365 56L006565 56R023490
Fe	KS160 TH2 FE8 (Total Hardness Buffer) KS63 FE6 (Thioglycolate Reagent)	Liquid reagent / 65 ml Liquid reagent / 65 ml Set	56L016065 56L006365 56R023590
Fe	VARIO (Fe in Mo) Rgt 1 VARIO (Fe in Mo) Rgt 2	Powder Pack / 100 Powder Pack / 100 Set	53 03 10 53 03 20 53 60 10

a) determination of free, combined and total

b) Thermoreactor is necessary for COD (150 °C), TOC (120 °C) and total -chromium, - phosphate, -nitrogen, (100 °C)

c) MultiDirect: Adapter is necessary for Vacu-vials[®] (Order code 19 20 75)

d) Spectroquant[®] is a Merck KGaA Trademark

e) alternative reagent, used instead of DPD No.1 / DPD No.3 in case of turbidity in the water sample caused by high concentration of calcium and/or high conductivity

f) additionally required for determination of bromine, chlorine dioxide and ozone in the presence of chlorine

g) Reagent recovers most insoluble iron oxides without digestion

h) additionally required for samples with hardness values above 300 mg/l CaCO₃

i) high range by dilution

j) Vacu-vials[®] is a Chemetrics Trademark

including stirring rod

Reagents

Test	Range	Wave lengths λ / nm							Method	Cuvette	
		MD 100	MD 200	MD 600 & MD 610	MultiDirect	PM 620 & PM 630	PM 600	SpectroDirect			
Lead (Pb²⁺)	0.1 - 5 mg/l	-	-	-	-	-	-	-	520	4-(2-Pyridylazo)-resorcine	10 mm □
Lead (Pb²⁺)	0.1 - 5 mg/l	-	-	-	-	-	-	-	515	4-(2-Pyridylazo)-resorcine	16 mm ø
Manganese	0.2 - 4 mg/l	530	-	530	530	-	-	-	450	Formaldoxime	24 mm ø
Manganese VARIO LR	0.01 - 0.7 mg/l	560	-	560	560	-	-	-	558	PAN	24 mm ø
Manganese VARIO HR	0.1 - 18 mg/l	530	-	530	530	-	-	-	525	Periodate oxidation ²	24 mm ø
Manganese	0.05 - 5 mg/l	-	-	430	-	-	-	-	-	Formaldoxime	24 mm ø
Molybdate / Molybdenum	1 - 50 mg/l 1 - 30 mg/l 0.6 - 30 mg/l	- - 430	- - -	430 - -	430 - -	- - -	- - -	- - -	- 366 -	Thioglycolate ⁴	24 mm ø
Molybdate / Molybdenum VARIO LR	0.5 - 5 mg/l 0.03 - 3 mg/l	- 610	- -	610 -	610 -	- -	- -	- -	610 -	Mercaptoacetic acid	24 mm ø
Molybdate / Molybdenum VARIO HR	0.5 - 66 mg/l 0.3 - 40 mg/l	- 430	- -	430 -	430 -	- -	- -	- -	420 -	Mercaptoacetic acid	24 mm ø
Molybdate / Molybdenum HR	1 - 100 mg/l 0.6 - 60 mg/l	- 430	- -	430 -	- -	- -	- -	- -	- -	Thioglycolate ⁴	24 mm ø
Nickel	0.02 - 1 mg/l 0.2 - 7 mg/l	- -	- -	- -	- -	- -	- -	- -	443 443	Dimethylglyoxime ^{2,3}	50 mm □ 24 mm ø
Nickel	0.1 - 10 mg/l	-	-	560	560	-	-	-	-	Nioxime	24 mm ø

MSDS (Material Safety Data Sheets): www.lovibond.com

For other reagent quantities please see our current price list.

Legend

¹ Deutsche Einheitsverfahren zur Wasser-, Abwasser- und Schlamm- Untersuchung

² Standard Methods for the Examination of Water and Wastewater, 18th Edition; 1992

³ Photometrische Analysenverfahren, Schwedt, Wissenschaftliche Verlagsgesellschaft mbH, Stuttgart; 1989

⁴ Photometrische Analyse, Lange/Vejdelek, Verlag Chemie; 1980

⁵ Colorimetric Chemical Analytical Methods, 9th Edition, Lovibond®

Display	Reagent	Form of reagent/Quantity	Order code
Pb	Spectroquant® 1.09717.0001 ^{d)}	Reagent test / 50 Tests	42 07 53
Pb	Spectroquant® 1.14833.0001 ^{d)}	Tube test / 25	42 07 54
Mn	MANGANESE LR 1 MANGANESE LR 2 Combi pack# MANGANESE LR 1 / LR 2 Combi pack# MANGANESE LR 1 / LR 2	Tablet / 100 Tablet / 100 each 100 each 250	51 60 80 BT 51 60 90 BT 51 76 21 BT 51 76 22 BT
Mn	VARIO Ascorbic Acid VARIO Alkaline-Cyanide VARIO PAN Indicator VARIO Rochelle Salt Solution ^{h)}	Powder Pack / 100 Liquid reagent / 60 ml Liquid reagent / 60 ml Set 30 ml	53 50 90 53 06 40
Mn	VARIO Manganese Citrate Puffer F10 VARIO Sodiumperiodate F10	Powder Pack / 100 Powder Pack / 100 Set	53 51 00
Mn	KS265 Manganese Reagent A KS266 Manganese Reagent B KS267 Manganese Reagent C	Liquid reagent / 30 ml Liquid reagent / 30 ml Liquid reagent / 30 ml Set	56L026530 56L026630 56L030430 56R024055
MoO ₄ MoO ₄ Mo	MOLYBDATE No.1 HR MOLYBDATE No.2 HR Combi pack# MOLYBDATE No.1 HR / No.2 HR Combi pack# MOLYBDATE No.1 HR / No.2 HR	Tablet / 100 Tablet / 100 each 100 each 250	51 30 60 BT 51 30 70 BT 51 76 31 BT 51 76 32 BT
MoO ₄ Mo	VARIO Molybdenum 1 LR F20 VARIO Molybdenum 2 LR required accessory: mixing cylinder (not included)	Powder Pack / 100 Liquid reagent/ 50 ml Set	53 54 50
MoO ₄ Mo	VARIO Molybdenum HR1 F10 VARIO Molybdenum HR2 F10 VARIO Molybdenum HR3 F10	Powder Pack / 100 Powder Pack / 100 Powder Pack / 100 Set	53 53 00
MoO ₄	KS63 (Thioglycolate Reagent)	Liquid reagent / 65 ml	56L006365
Ni	Nickel-51, Nickel-52	Reagent test (Powder, Liquid reagent) / 50 Tests	2 41 90 33
Ni	NICKEL No.1 NICKEL No.2	Tablet / 100 Tablet / 100	51 56 30 BT 51 56 40 BT

^{a)} determination of free, combined and total

^{b)} Thermoreactor is necessary for COD (150 °C), TOC (120 °C) and total -chromium, - phosphate, -nitrogen, (100 °C)

^{c)} MultiDirect: Adapter is necessary for Vacu-vials® (Order code 19 20 75)

^{d)} Spectroquant® is a Merck KGaA Trademark

^{e)} alternative reagent, used instead of DPD No.1 / DPD No.3 in case of turbidity in the water sample caused by high concentration of calcium and/or high conductivity
^{f)} additionally required for determination of bromine, chlorine dioxide and ozone in the presence of chlorine

^{g)} Reagent recovers most insoluble iron oxides without digestion

^{h)} additionally required for samples with hardness values above 300 mg/l CaCO₃

ⁱ⁾ high range by dilution

^{j)} Vacu-vials® is a Chemetrics Trademark

including stirring rod

Reagents

Test	Range	Wave lengths λ / nm							Method	Cuvette
		MD 100	MD 200	MD 600 & MD 610	MultiDirect	PM 620 & PM 630	PM 600	SpectroDirect		
Nitrate	0.08 - 1 mg/l	-	-	530	-	-	-	-	Zinc reduction / NED	24 mm \emptyset
Nitrate VARIO	1 - 30 mg/l	-	-	430	430	-	-	410	Chromotropic acid	16 mm \emptyset
Nitrate	0.5 - 14 mg/l	-	-	-	-	-	-	340	2,6-Dimethylphenole ³	16 mm \emptyset
Nitrite	0.01 - 0.5 mg/l	-	-	560	560	-	-	545	N-(1-Naphthyl)-ethylenediamine ^{2,3}	24 mm \emptyset
Nitrite	0.03 - 0.6 mg/l 0.3 - 3 mg/l	-	-	-	-	-	-	545 545	Sulfanilic/Naphthylamine ¹	16 mm \emptyset
Nitrite LR VARIO	0.01 - 0.3 mg/l	-	-	530	530	-	-	507	Diazotation	24 mm \emptyset
Nitrogen-total ^{b)}	0.5 - 14 mg/l 5 - 140 mg/l ¹⁾	-	-	-	-	-	-	340	2,6-Dimethylphenole 2,3	16 mm \emptyset
Nitrogen VARIO, total LR ^{b)}	0.5 - 25 mg/l	-	-	430	430	-	-	410	Persulphate-digestion method	16 mm \emptyset
Nitrogen VARIO, total HR ^{b)}	5 - 150 mg/l	-	-	430	430	-	-	410	Persulphate-digestion method	16 mm \emptyset
Oxygen, activ	0.1 - 10 mg/l	-	-	530	530	530	-	-	DPD	
Oxygen, dissolved ^{c)}	10 - 800 μ g/l	530	-	530	530	-	-	-	Rhodazine D TM	13 mm \emptyset

MSDS (Material Safety Data Sheets): www.lovibond.com

For other reagent quantities please see our current price list.

Legend

¹ Deutsche Einheitsverfahren zur Wasser-, Abwasser- und Schlamm- Untersuchung

² Standard Methods for the Examination of Water and Wastewater, 18th Edition; 1992

³ Photometrische Analysenverfahren, Schwedt, Wissenschaftliche Verlagsgesellschaft mbH, Stuttgart; 1989

⁴ Photometrische Analyse, Lange/Vejdelek, Verlag Chemie; 1980

⁵ Colorimetric Chemical Analytical Methods, 9th Edition, Lovibond®

Display	Reagent	Form of reagent/Quantity	Order code
N	NITRATE TEST Powder NITRATE TEST Tablet NITRITE LR Nitrate test tube	Powder / 15 g Tablet / 100 Tablet / 100	46 52 30 50 28 10 51 23 10BT 36 62 20
N	VARIO Nitrate Chromotropic VARIO Nitra X Reagent tube VARIO Deionised Water (for Zero)	Powder Pack / 50 Reaction tube / 50 Bottle, 100 ml Set (Tube test)	53 55 80
N	Reaction tube, Nitrat-111	Tube test Liquid reagent / 24	2 42 07 02
N	NITRITE LR	Tablet / 100	51 23 10 BT
N	Reaction tube, Nitrit-101	Tube test (Powder) / 24	2 41 90 18
N	VARIO Nitri 3	Powder Pack / 100	53 09 80
N	Digestion reagent, Compensation reagent, Nitrat-111	Tube test (Powder, Liquid reagent) / 24	2 42 07 03
N	VARIO TN HYDROX. LR Tubes VARIO PERSULFATE Reagent VARIO TN Reagent A VARIO TN Reagent B VARIO TN ACID LR/HR Tubes VARIO Deionised Water (for Zero)	Digestion tubes / 50 Powder Pack / 50 Powder Pack / 50 Powder Pack / 50 Reaction tubes / 50 Bottle, 100 ml Set (Tube test)	53 55 50
N	VARIO TN HYDROX. HR Tubes VARIO PERSULFATE Reagent VARIO TN Reagent A VARIO TN Reagent B VARIO TN ACID LR/HR Tubes VARIO Deionised Water (for Zero)	Digestion tubes / 50 Powder Pack / 50 Powder Pack / 50 Powder Pack / 50 Reaction tubes / 50 Bottle, 100 ml Set (Tube test)	53 55 60
O ₂	DPD No. 4	Tablet / 100	51 12 20 BT
O ₂	Vacu-vial® ^{j)}	Liquid reagent / 30. Adapter for Vacu-vials® ^{j)}	38 04 50 19 20 75

^{a)} determination of free, combined and total

^{b)} Thermoreactor is necessary for COD (150 °C), TOC (120 °C) and total -chromium, - phosphate, -nitrogen, (100 °C)

^{c)} MultiDirect: Adapter is necessary for Vacu-vials® (Order code 19 20 75)

^{d)} Spectroquant® is a Merck KGaA Trademark

^{e)} alternative reagent, used instead of DPD No.1 / DPD No.3 in case of turbidity in the water sample caused by high concentration of calcium and/or high conductivity additionally required for determination of bromine, chlorine dioxide and ozone in the presence of chlorine

^{g)} Reagent recovers most insoluble iron oxides without digestion

^{h)} additionally required for samples with hardness values above 300 mg/l CaCO₃

ⁱ⁾ high range by dilution

^{j)} Vacu-vials® is a Chemetrics Trademark

including stirring rod

Reagents

Test	Range	Wave lengths λ / nm							Method	Cuvette
		MD 100	MD 200	MD 600 & MD 610	MultiDirect	PM 620 & PM 630	PM 600	SpectroDirect		
Ozone	0.02 - 1 mg/l	-	-	-	-	-	-	510	DPD/Glycine ⁵	24 mm \emptyset 50 mm \square 24 mm \emptyset
	0.02 - 0.5 mg/l	-	-	-	-	-	-	510		
	0.02 - 2 mg/l	530	-	530	530	530	530	-		
Phenols	0.1 - 5 mg/l	-	-	-	-	-	-	507	4-Aminoantipyrine ¹	24 mm \emptyset
PHMB (Biguanide)	2 - 60 mg/l	-	-	560	560	560	-	-	Buffer/Indicator	24 mm \emptyset
Phosphate-total LR ^{b)}	0.07 - 3 mg/l	-	-	-	-	-	-	690	Phosphomolybdic acid/ Ascorbic acid ²	16 mm \emptyset
	0.2 - 10 mg/l	-	-	-	-	-	-	690		
Phosphate-total HR ^{b)}	1.5 - 20 mg/l	-	-	-	-	-	-	690	Phosphomolybdic acid/ Ascorbic acid ²	16 mm \emptyset
	5 - 60 mg/l	-	-	-	-	-	-	690		
Phosphate LR , ortho	0.05 - 4 mg/l	660	-	660	660	610	610	710	Phosphomolybdic acid/ Ascorbic acid ²	24 mm \emptyset
Phosphate HR , ortho	1 - 80 mg/l	-	-	430	430	-	-	470	Vanadomolybdate ²	24 mm \emptyset
Phosphate VARIO ortho	0.06 - 2.5 mg/l	660	-	660	660	-	-	890	Phosphomolybdenum blue/ Ascorbic acid ²	24 mm \emptyset
Phosphate VARIO ortho	0.06 - 5 mg/l	-	-	660	660	-	-	890	Phosphomolybdenum blue/ Ascorbic acid ²	16 mm \emptyset
Phosphate-ortho	3 - 60 mg/l	-	-	-	-	-	-	438	Vanadomolybdate ²	16 mm \emptyset
Phosphate VARIO ^{b)} acid hydrolyzable and total	acid hydrolyzable: 0.02 - 1.6 mg/l	-	-	660	660	-	-	890	Acid digestion Phosphomolybdenum blue/ Ascorbic acid ²	16 mm \emptyset
	total: 0.02 - 1.1 mg/l 0.06 - 3.5 mg/l	-	-	-	-	-	-	-		

MSDS (Material Safety Data Sheets): www.lovibond.com

For other reagent quantities please see our current price list.

Legend

¹ Deutsche Einheitsverfahren zur Wasser-, Abwasser- und Schlamm- Untersuchung

² Standard Methods for the Examination of Water and Wastewater, 18th Edition; 1992

³ Photometrische Analysenverfahren, Schwedt, Wissenschaftliche Verlagsgesellschaft mbH, Stuttgart; 1989

⁴ Photometrische Analyse, Lange/Vejdelek, Verlag Chemie; 1980

⁵ Colorimetric Chemical Analytical Methods, 9th Edition, Lovibond®

Display	Reagent	Form of reagent/Quantity	Order code
O ₃	DPD No. 1	Tablet / 100	51 10 50 BT
	DPD No. 3	Tablet / 100	51 10 80 BT
	Combi pack# DPD No.1 / No.3	each 100	51 77 11 BT
	Combi pack# DPD No.1 / No.3	each 250	51 77 12 BT
	GLYCINE ^{f)}	Tablet / 100	51 21 70 BT
	Combi pack# DPD No.1 / GLYCINE	each 100	51 77 31 BT
C ₆ H ₅ O _H	PHENOLE No. 1	Tablet / 100	51 59 50
	PHENOLE No. 2	Tablet / 100	51 59 60 BT
PHMB	PHMB PHOTOMETER	Tablet / 100	51 61 00 BT
P PO ₄	Reaction tube, Phosphat-101, Phosphat- 102, Phosphat-103	Tube test (Powder, Liquid reagent) / 24	2 41 90 19
P PO ₄	Reaction tube, Phosphat-101, Phosphat-102, Phosphat-103	Tube test (Powder, Liquid reagent) / 24	2 42 07 00
PO ₄	PHOSPHATE No. 1 LR	Tablet / 100	51 30 40 BT
	PHOSPHATE No. 2 LR	Tablet / 100	51 30 50 BT
	Combi pack# PHOSPHATE No.1 LR / No.2 LR	each 100	51 76 51 BT
PO ₄	PHOSPHATE No. 1 HR	Tablet / 100	51 58 10 BT
	PHOSPHATE No. 2 HR	Tablet / 100	51 58 20 BT
	Combi pack# PHOSPHATE No.1 HR / No.2 HR	each 100	51 76 61 BT
PO ₄	VARIO PHOSPHATE RGT, F10	Powder Pack / 100	53 15 50
PO ₄	VARIO Dilution Vial VARIO PHOSPHATE RGT, F10 VARIO Deionised Water (for Zero)	50 Tubes Powder Pack / 50 Bottle, 100 ml Set (Tube test)	53 52 00
PO ₄	Reaction tube	Tube test / 24	2 42 07 01
P PO ₄ P PO ₄	VARIO Acid Reagent Vial VARIO PHOSPHATE RGT, F10 VARIO Deionised Water (for Zero) 1N NaOH 1,54 N NaOH VARIO Potassium Persulfate F10	50 Tubes Powder Pack / 50 Bottle, 100 ml Bottle / 100 ml Bottle / 100 ml Powder Pack / 50 Set (Tube test)	53 52 50

a) determination of free, combined and total

b) Thermoreactor is necessary for COD (150 °C), TOC (120 °C) and total -chromium, - phosphate, -nitrogen, (100 °C)

c) MultiDirect: Adapter is necessary for Vacu-vials® (Order code 19 20 75)

d) Spectroquant® is a Merck KGaA Trademark

e) alternative reagent, used instead of DPD No.1 / DPD No.3 in case of turbidity in the water sample caused by high concentration of calcium and/or high conductivity additionally required for determination of bromine, chlorine dioxide and ozone in the presence of chlorine

g) Reagent recovers most insoluble iron oxides without digestion

h) additionally required for samples with hardness values above 300 mg/l CaCO₃

i) high range by dilution

j) Vacu-vials® is a Chemetrics Trademark

including stirring rod

Reagents

Test	Range	Wave lengths λ / nm							Method	Cuvette
		MD 100	MD 200	MD 600 & MD 610	MultiDirect	PM 620 & PM 630	PM 600	SpectroDirect		
Phosphate VARIO total ^{b)}	0.02 - 1.1 mg/l	-	-	660	660	-	-	890	Acid-/ Persulphate digestion Ascorbic acid ²	16 mm \emptyset
	0.06 - 3.5 mg/l									16 mm \emptyset
Phosphate, ortho ^{c)}	5 - 40 mg/l	-	-	430	430	-	-	-	Vanadomolybdate ²	
Phosphate, ortho ^{c)}	0.05 - 5 mg/l	-	-	660	660	-	-	-	Stannous chloride ²	
Phosphate LR	0.1 - 10 mg/l	-	-	660	-	-	-	-	Phosphomolybdic acid/ Ascorbic acid ²	24 mm \emptyset
Phosphate HR, ortho	5 - 80 mg/l	430	-	430	-	-	-	-	Vanadomolybdate ²	24 mm \emptyset
Phosphonate VARIO	0.02 - 125 mg/l	-	-	660	660	-	-	660	Persulfate UV-Oxidation	24 mm \emptyset
pH value	5.2 - 6.8	-	-	560	560	560	-	-	Bromcresol purple ⁵	24 mm \emptyset
pH value	6.5 - 8.4	560	560	560	560	560	560	558	Phenol red ⁵	24 mm \emptyset
pH value	6.5 - 8.4	560	560	560	560	560	-	558	Phenol red ⁵	24 mm \emptyset
pH value	8.0 - 9.6	-	-	560	560	560	-	-	Thymol blue ⁵	24 mm \emptyset
Polyacrylates	1 - 30 mg/l	530	-	660	-	-	-	-	Turbidity	24 mm \emptyset

MSDS (Material Safety Data Sheets): www.lovibond.com

For other reagent quantities please see our current price list.

Legend

¹ Deutsche Einheitsverfahren zur Wasser-, Abwasser- und Schlamm- Untersuchung

² Standard Methods for the Examination of Water and Wastewater, 18th Edition; 1992

³ Photometrische Analysenverfahren, Schwedt, Wissenschaftliche Verlagsgesellschaft mbH, Stuttgart; 1989

⁴ Photometrische Analyse, Lange/Vejdelek, Verlag Chemie; 1980

⁵ Colorimetric Chemical Analytical Methods, 9th Edition, Lovibond®

Display	Reagent	Form of reagent/Quantity	Order code
P PO ₄	VARIO Acid Reagent Vial VARIO PHOSPHATE RGT, F10 VARIO Deionised Water (for Zero) 1,54 N NaOH VARIO Potassium Persulfate F10	50 Tubes Powder Pack / 50 Bottle, 100 ml Bottle / 100 ml Powder Pack / 50 Set (Tube test)	53 52 10
PO ₄	Vacu-vial® ^{j)}	Test Kit / 30 Adapter for Vacu-vials® ^{j)}	38 04 60 19 20 75
PO ₄	Vacu-vial® ^{j)}	Test Kit / 30 Adapter for Vacu-vials® ^{j)}	38 04 80 19 20 75
PO ₄	KS80 (CRP Reagent) KP119 (Ascorbic acid)	Liquid reagent / 2 x 65 ml Powder / 20 g Set	56L008065 56P011920 56R023765
PO ₄	KS228 (Ammonia Molybdate) KS229 (Ammonia Metavanadate) Option Polyphosphate KS278 (50 % Sulfuric Acid) KS135 (Phenolphthalein Indicator) KS144 (Calcium Hardness Buffer) KP962 (Ammonium Persulphate Powder)	Liquid reagent / 65 ml Liquid reagent / 65 ml Set Liquid reagent / 65 ml Liquid reagent / 65 ml Liquid reagent / 65 ml Powder / 40 g	56L022865 56L022965 56R019090 56L027865 56L013565 56L014465 56P096240
PO ₄	VARIO Potassium Persulfate F10 VARIO PHOSPHATE RGT, F10	Powder Pack / 100 Powder Pack / 200 Set	53 52 20
pH	BROMOCRESOLPURPLE/PHOTOMETER	Tablet / 100	51 57 00 BT
pH	PHENOLRED / PHOTOMETER	Tablet / 100	51 17 70 BT
pH	PHENOLRED Solution	Liquid reagent / 15 ml	47 10 40
pH	THYMOLBLUE / PHOTOMETER	Tablet / 100	51 57 10
Polyacryl	KS255 (Polyacrylate Reagent 1) KS256 (Polyacrylate Reagent 2) KS336 (Propan-2-ol) C18 (Cartouche) KS173 (2,4 Dinitrophenol) KT183 (Nitric Acid)	Liquid reagent / 65 ml Liquid reagent / 65 ml Set Liquid reagent / 65 ml Liquid reagent / 65 ml Liquid reagent / 65 ml	56L025565 56L025665 56R019165 56L033665 56A020101 56L017365 56L018365

^{a)} determination of free, combined and total

^{b)} Thermoreactor is necessary for COD (150 °C), TOC (120 °C) and total -chromium, - phosphate, -nitrogen, (100 °C)

^{c)} MultiDirect: Adapter is necessary for Vacu-vials® (Order code 19 20 75)

^{d)} Spectroquant® is a Merck KGaA Trademark

^{e)} alternative reagent, used instead of DPD No.1 / DPD No.3 in case of turbidity in the water sample caused by high concentration of calcium and/or high conductivity additionally required for determination of bromine, chlorine dioxide and ozone in the presence of chlorine

^{g)} Reagent recovers most insoluble iron oxides without digestion

^{h)} additionally required for samples with hardness values above 300 mg/l CaCO₃

ⁱ⁾ high range by dilution

^{j)} Vacu-vials® is a Chemetrics Trademark

including stirring rod

Reagents

Test	Range	Wave lengths λ / nm							Method	Cuvette	
		MD 100	MD 200	MD 600 & MD 610	MultiDirect	PM 620 & PM 630	PM 600	SpectroDirect			
Potassium	0.7 - 12 mg/l 1 - 10 mg/l	-	-	430	430	-	-	-	730	Tetraphenylborate-Turbidity ⁴	24 mm \emptyset 24 mm \emptyset
Silica	0.05 - 4 mg/l 0.05 - 3 mg/l	660	-	660	660	-	-	-	820	Silicomolybdate ^{2,3}	24 mm \emptyset
Silica VARIO LR	0.1 - 1.6 mg/l	660	-	660	660	-	-	-	815	Heteropolyblue ²	24 mm \emptyset
Silica VARIO HR	1 - 90 mg/l 1 - 100 mg/l	430	-	430	430	-	-	-	452	Silicomolybdate ^{2,3}	24 mm \emptyset 24 mm \emptyset
Silica	0.1 - 8 mg/l	-	-	430	-	-	-	-	-	Heteropolyblue ²	24 mm \emptyset
Sodiumhypochlorite	0.2 - 16 %	-	-	530	530	530	530	-	-	Potassium iodide ⁵	24 mm \emptyset
Spectral Absorption-coefficient	0 - 50 m ⁻¹	-	-	-	-	-	-	-	436 525 620	Direct reading ¹ ISO 7887:1994	50 mm \square
Sulphate VARIO	5 - 100 mg/l 2 - 100 mg/l	530	-	530	530	530	-	-	450	Bariumsulphate Turbidity ²	24 mm \emptyset
Sulphate	5 - 100 mg/l	-	-	610	610	610	-	-	-	Bariumsulphate Turbidity ²	24 mm \emptyset

MSDS (Material Safety Data Sheets): www.lovibond.com

For other reagent quantities please see our current price list.

Legend

¹ Deutsche Einheitsverfahren zur Wasser-, Abwasser- und Schlamm- Untersuchung

² Standard Methods for the Examination of Water and Wastewater, 18th Edition; 1992

³ Photometrische Analysenverfahren, Schwedt, Wissenschaftliche Verlagsgesellschaft mbH, Stuttgart; 1989

⁴ Photometrische Analyse, Lange/Vejdelek, Verlag Chemie; 1980

⁵ Colorimetric Chemical Analytical Methods, 9th Edition, Lovibond®

Display	Reagent	Form of reagent/Quantity	Order code
K	POTASSIUM T	Tablet / 100	51 56 70
SiO ₂	SILICA No. 1 SILICA No. 2 Combi pack [#] SILICA No.1 / No.2 Combi pack [#] SILICA No.1 / No.2 SILICA PR	Tablet / 100 Tablet / 100 each 100 each 250 Tablet / 100	51 31 30 BT 51 31 40 BT 51 76 71 BT 51 76 72 BT 51 31 50 BT
SiO ₂	VARIO Amino Acid F10 VARIO Citric Acid F10 VARIO Molybdate 3 Reagent solution	Powder Pack / 100 Powder Pack / 200 Liquid reagent / 2 x 50 ml Set	53 56 90
SiO ₂	VARIO Silica HR Molybdate F10 VARIO Silica HR Acid Rgt F10 VARIO Silica HR Citric Acid F10	Powder Pack / 100 Powder Pack / 100 Powder Pack / 100 Set	53 57 00
SiO ₂	KS104 (Silica Reagent 1) KS105 (Silica Reagent 2) KP106 (Silica Reagent 3)	Liquid reagent / 65 ml Liquid reagent / 65 ml Powder / 10 g Set	56L010465 56L010565 56P010610 56R023856
NaOCl	ACIDIFYING GP CHLORINE HR (KI) Combi pack [#] CHLORINE HR (KI)/ACIDIFYING GP Combi pack [#] CHLORINE HR (KI)/ACIDIFYING GP Dilution set for sample preparation	Tablet / 100 Tablet / 100 each 100 each 250 1 set	51 54 80 BT 51 30 00 BT 51 77 21 BT 51 77 22 BT 41 44 70
-	no reagents required	-	-
SO ₄	VARIO Sulpha 4 / F10	Powder Pack / 100	53 21 60
SO ₄	SULFATE T	Tablet / 100	51 54 50 BT

a) determination of free, combined and total

b) Thermoreactor is necessary for COD (150 °C), TOC (120 °C) and total -chromium, - phosphate, -nitrogen, (100 °C)

c) MultiDirect: Adapter is necessary for Vacu-vials® (Order code 19 20 75)

d) Spectroquant® is a Merck KGaA Trademark

e) alternative reagent, used instead of DPD No.1 / DPD No.3 in case of turbidity in the water sample caused by high concentration of calcium and/or high conductivity

f) additionally required for determination of bromine, chlorine dioxide and ozone in the presence of chlorine

g) Reagent recovers most insoluble iron oxides without digestion

h) additionally required for samples with hardness values above 300 mg/l CaCO₃

i) high range by dilution

j) Vacu-vials® is a Chemetrics Trademark

including stirring rod

Reagents

Test	Range	Wave lengths λ / nm							Method	Cuvette
		MD 100	MD 200	MD 600 & MD 610	MultiDirect	PM 620 & PM 630	PM 600	SpectroDirect		
Sulphide	0.04 - 0.5 mg/l	-	-	660	660	-	-	668	DPD/Catalyst ^{3,4}	24 mm \emptyset
Sulphite	0.1 - 5 mg/l	-	-	430	430	-	-	-	DTNB	24 mm \emptyset
	0.1 - 10 mg/l	-	-	-	-	-	-	405		10 mm \emptyset
	0.05 - 4 mg/l	-	-	-	-	-	-	405		24 mm \emptyset
Suspended solids	5 - 750 mg/l	660	-	660	660	-	-	- 660	Turbidity/Attenuated Radiation	24 mm \emptyset 50 mm \square
TOC^{b)}	50 - 800 mg/l	-	-	-	-	-	-	596	H ₂ SO ₄ / Indicator	16 mm \emptyset
Triazoles (UV lamp requested)	1 - 16 mg/l	430	-	430	-	-	-	-	Catalyzed UV Digestion	24 mm \emptyset
Turbidity	5 - 500	-	-	-	-	-	-	860	Attenuated Radiation Method Attenuated Radiation Method	50 mm \square
	0 - 1000	-	-	530	530	-	-	-		24 mm \emptyset
Urea	0.1 - 2.5 mg/l	610	610	610	610	610	-	-	Urease / Indophenol	24 mm \emptyset
	0.2 - 5 mg/l ¹⁾	610	610	-	-	-	-	-		
	0.1 - 2 mg/l	-	-	-	-	-	-	676		
Zinc	0.02 - 1 mg/l	-	-	610	610	-	-	-	Zincon ³ /EDTA	24 mm \emptyset
	0.02 - 0.5 mg/l	-	-	-	-	-	-	616		
Zinc	0.1 - 2.5 mg/l	-	-	610	-	-	-	-	Zincon ³ /EDTA	24 mm \emptyset

MSDS (Material Safety Data Sheets): www.lovibond.com

For other reagent quantities please see our current price list.

Legend

¹ Deutsche Einheitsverfahren zur Wasser-, Abwasser- und Schlamm- Untersuchung

² Standard Methods for the Examination of Water and Wastewater, 18th Edition; 1992

³ Photometrische Analysenverfahren, Schwedt, Wissenschaftliche Verlagsgesellschaft mbH, Stuttgart; 1989

⁴ Photometrische Analyse, Lange/Vejdelek, Verlag Chemie; 1980

⁵ Colorimetric Chemical Analytical Methods, 9th Edition, Lovibond®

Display	Reagent	Form of reagent/Quantity	Order code
S	SULFIDE No. 1 SULFIDE No. 2	Tablet / 100 Tablet / 100	50 29 30 50 29 40
SO ₃	SULFITE LR	Tablet / 100	51 80 20 BT
-	no reagents required	-	-
TOC	Spectroquant® 1.14879.0001 ^{d)}	Tube test / 25 Aluminium screwcaps / 6 pc.	42 07 56 42 07 57
Benzotriazole	VARIO Triazole Rgt F25	Powder Pack / 100	53 22 00
FAU FAU	no reagents required	-	-
CH ₄ N ₂ O	UREA Reagent 1 UREA Reagent 2 AMMONIA No. 1 AMMONIA No. 2 Combi pack [#] AMMONIA No.1 / No.2 Combi pack [#] AMMONIA No.1 / No.2 UREA PRETREAT (compensates for the interference of free Chlorine up to 2 mg/l) UREA Reagent Set, contains: UREA Reagent 1/2, AMMONIA No.1/2, UREA PRETREAT	Liquid reagent / 15 ml Liquid reagent / 10 ml Tablet / 100 Tablet / 100 each 100 each 250 Tablet / 100 Set	45 93 00 45 94 00 51 25 80 BT 51 25 90 BT 51 76 11 BT 51 76 12 BT 51 61 10 BT 51 78 00 BT
Zn	COPPER/ZINC LR EDTA DECHLOR (in case of high levels of residual chlorine)	Tablet / 100 Tablet / 100 Tablet / 100	51 26 20 BT 51 23 90 BT 51 23 50 BT
Zn	KS243 (Zinc Reagent 1) KP244 (Zinc Reagent 2)	Liquid reagent / 65 ml Powder / 20 g Set	56L024365 56L024420 56R023965

^{a)} determination of free, combined and total

^{b)} Thermoreactor is necessary for COD (150 °C), TOC (120 °C) and total -chromium, - phosphate, -nitrogen, (100 °C)

^{c)} MultiDirect: Adapter is necessary for Vacu-vials® (Order code 19 20 75)

^{d)} Spectroquant® is a Merck KGaA Trademark

^{e)} alternative reagent, used instead of DPD No.1 / DPD No.3 in case of turbidity in the water sample caused by high concentration of calcium and/or high conductivity
^{f)} additionally required for determination of bromine, chlorine dioxide and ozone in the presence of chlorine

^{g)} Reagent recovers most insoluble iron oxides without digestion

^{h)} additionally required for samples with hardness values above 300 mg/l CaCO₃

ⁱ⁾ high range by dilution

^{j)} Vacu-vials® is a Chemetrics Trademark

[#] including stirring rod

PD 250 Powder Dispenser



Highlights

- Determination of chlorine according to ISO 7393-2:2000 (free + total)
- 250 tests
- 5 years reagent shelf life (before opening)
- Easy handling
- Precise dosage

Precise and repeatable dosing of Powder Reagents

The PD250 is designed for easy and controlled dosage of DPD powder reagents. One click gives the exact amount of reagent required for a 10 ml sample. The PD 250 is the perfect alternative to the Powder Packs for those carrying out a number of tests, saving time while also reducing the amount of packaging waste.

The reagent is supplied in sealed glass vials, sufficient for up to 250 tests. The protective sealing enables a shelf life of up to 5 years although, once the vial has been opened, the contents should be used within 6 months. The vials can be changed quickly and easily. Furthermore, the dispenser can be thoroughly cleaned and the ergonomic design allows for comfort during operation.

Refill Packs

Article	Order code
VARIO Chlorine Free 10 ml 2 reagent vials	53 01 40
VARIO Chlorine Total 10 ml 2 reagent vials	53 01 50
VARIO Chlorine Free + Total 10 ml one reagent vial each	53 01 60



Delivery Content

PD 250 in carton including
1 reagent vial and instruction manual

PD 250 Set 1 - Free Chlorine

- 1 powder dispenser "Free Chlorine"
- 1 reagent vial "Free Chlorine"
- 1 instruction manual
- 1 protective sleeve (rubber)

Order code: 19 49 00

PD 250 Set 2 - Total Chlorine

- 1 powder dispenser "Total Chlorine"
- 1 reagent vial "Total Chlorine"
- 1 instruction manual
- 1 protective sleeve (rubber)

Order code: 19 49 10

Easy Handling

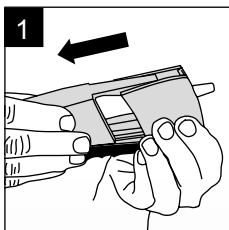

Remove the dispenser cover.

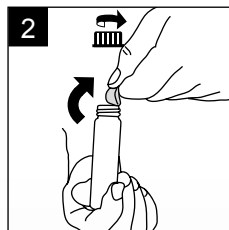

Uncap the reagent vial and remove the seal. Use material within 6 months of removing the seal.

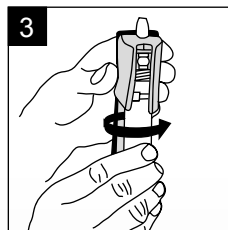

Hold the dispenser with the tip upright and screw the vial on to the dispenser.

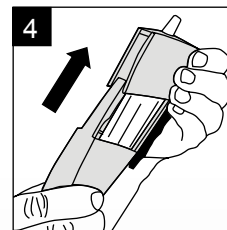

Slide the cover into the grooves until the lower end snaps into place.

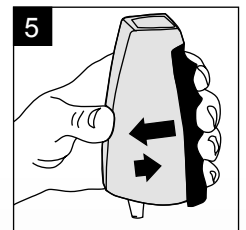

To use: Hold with the tip down and press the blue handle towards the dispenser body. Release quickly. Releasing the handle quickly helps prevent powder build up.

Reagents also compatible in Hach®

VARIO Powder Packs (PP) and Reagents for Photometry

Test	Range	Reagent	Liquid Reagent	Tube Tests	Powder Pack
Aluminium	0 – 0.22 mg/l Al	VARIO Aluminium Reagent, Set F20 consists of: VARIO Aluminium ECR VARIO Aluminium Hexamine VARIO Aluminium Masking Rgt	■		■ ■
Ammonia	0 – 0.5 mg/l N	VARIO Ammonia Nitrogen, Set F10 consists of: VARIO Ammonia Salicylate, F10 VARIO Ammonia Cyanurate, F10			■ ■
Ammonia LR	0 – 2.5 mg/l N	VARIO Am tube test Reagent, Set LR, F5 consists of: VARIO Ammonia Salicylate, F5 VARIO Ammonia Cyanurate, F5 VARIO Am Diluent Reagent Low Range		■	■ ■
Ammonia HR	0 – 50 mg/l N	VARIO Am tube test Reagent, Set HR, F5 consists of: VARIO Ammonia Salicylate, F5 VARIO Ammonia Cyanurate, F5 VARIO Am Diluent Reagent High Range		■	■ ■
Bromine	0.05 – 4.5 mg/l Br	VARIO Chlorine TOTAL-DPD, F10 VARIO Chlorine TOTAL-DPD, F10			■ ■
Chlorine free, combined and total Chlorine dioxide	Visual Test Kit up to 3.5mg/l Cl ₂	VARIO Chlorine FREE-DPD, F5 VARIO Chlorine FREE-DPD, F5 VARIO Chlorine TOTAL-DPD, F5 VARIO Chlorine TOTAL-DPD, F5			■ ■ ■ ■
	0.01 – 2 mg/l Cl ₂	VARIO Chlorine FREE-DPD, F10 VARIO Chlorine FREE-DPD, F10 VARIO Chlorine TOTAL-DPD, F10 VARIO Chlorine TOTAL-DPD, F10			■ ■ ■ ■
	0 – 5 mg/l Cl ₂	VARIO Chlorine FREE-DPD, F25 VARIO Chlorine FREE-DPD, F25 VARIO Chlorine TOTAL-DPD, F25 VARIO Chlorine TOTAL-DPD, F25			■ ■ ■ ■
COD LR	0 – 150 mg/l O ₂	COD VARIO 0 - 150 mg/l		■ ■	
COD MR	0 – 1500 mg/l O ₂	COD VARIO 0 - 1500 mg/l		■ ■ ■	
COD HR	0 – 15000 mg/l O ₂	COD VARIO 0 - 15000 mg/l		■ ■	
Copper	0 – 5 mg/l Cu	VARIO CU1, F10 VARIO CU1, F10			■ ■
DEHA	20 - 500 µg/l DEHA	VARIO DEHA REAGENT SET consists of: VARIO OXYSCAV 1 RGT VARIO DEHA 2 RGT	■		■

devices*

Method	Applications	Quantity	Code
Eriochrome cyanine R	Water	1 Set 100 100 25 ml	53 50 00
Salicylate	Water, waste water, seawater	1 Set 2 x 100 2 x 100	53 55 00
Salicylate	Water, waste water, seawater	1 Set 50 50 50 tubes	53 56 00
Salicylate	Water, waste water, seawater	1 Set 50 50 50 tubes	53 56 50
DPD-Method: USEPA accepted for drinking water analysis	Water, waste water, seawater	100 1000	53 01 20 53 01 23
DPD method: USEPA accepted for drinking water analysis	Water, waste water, seawater	100 1000 100 1000	53 00 90 53 00 93 53 00 80 53 00 83
DPD method: USEPA accepted for drinking water analysis	Water, waste water, seawater	100 1000 100 1000	53 01 00 53 01 03 53 01 20 53 01 23
DPD method: USEPA accepted for drinking water analysis	Water, waste water, seawater	100 1000 100 1000	53 01 10 53 01 13 53 01 30 53 01 33
Dichromate Reactor, Digestion	Water, waste water, seawater	25 tubes 150 tubes 25 tubes, mercury free	2 42 07 20 2 42 07 25 2 42 07 10
Dichromate Reactor, Digestion	Water, waste water, seawater	25 tubes 150 tubes 25 tubes, mercury free 150 tubes, mercury free	2 42 07 21 2 42 07 26 2 42 07 11 2 42 07 16
Dichromate Reactor, Digestion	Water, waste water, seawater	25 tubes 150 tubes 25 tubes, mercury free	2 42 07 22 2 42 07 27 2 42 07 12
Bicinchoninate	Water, waste water, seawater	100 1000	53 03 00 53 03 03
PPST		1 Set 100 100 ml	53 60 00



MSDS (Material Safety Data Sheets): www.lovibond.com

* HACH® is a registered trademark of Hach Company, Loveland, Colorado. The use of the HACH® trademark does not imply any affiliation with or approval by Hach Company regarding the formulation, testing or compatibility of these products for use in HACH® brand spectrophotometers or other devices or systems.

Reagents also compatible in Hach®

VARIO Powder Packs (PP) and Reagents for Photometry

Test	Range	Reagent	Liquid Reagent	Tube Tests	Powder Pack
Hydrazine	0.005 – 0.6 mg/l N ₂ H ₄	VARIO Hydra2 Reagent	■		
Iron (Fe ²⁺ , Fe ³⁺), dissolved	0 – 3 mg/l Fe 0 – 1.8 mg/l Fe	VARIO Ferro, F10 VARIO IRON TPTZ			■ ■
Iron, total, Fe in Mo	0.01 – 1.8 mg/l	VARIO (Fe in Mo) Reagent Set consists of: VARIO (Fe in Mo) Rgt 1 VARIO (Fe in Mo) Rgt 2			■ ■
Manganese LR	0 – 0.7 mg/l Mn	VARIO Manganese Reagent, Set LR, F10 consists of: VARIO Alkaline-Cyanide Reagent Solution VARIO Ascorbic Acid VARIO PAN Indicator Solution	■ ■		■
Manganese HR	0 – 20 mg/l Mn	VARIO Manganese Reagent, Set HR, F10 consists of: VARIO MANGANESE CITRATE BUFFER, F10 VARIO SODIUMPERIODATE, F10			■ ■
Molybdate LR	0.5 – 5 mg/l MoO ₄	VARIO MOLYBDENUM LR, Set, F10 consists of: VARIO Molybdenum 1 LR, F10 VARIO Molybdenum 2 LR, F10			■ ■
Molybdate HR	0 – 35 mg/l Mo	VARIO MOLYBDENUM HR, Set F10 consists of: VARIO MOLYBDENUM HR1, F10 VARIO MOLYBDENUM HR2, F10 VARIO MOLYBDENUM HR3, F10			■ ■ ■
	0 – 35 mg/l Mo	VARIO MOLYBDENUM HR, Set F25 consists of: VARIO MOLYBDENUM HR1, F25 VARIO MOLYBDENUM HR2, F25 VARIO MOLYBDENUM HR3, F25			■ ■ ■
Nitrate	0 – 30 mg/l N	VARIO NITRA X Reagent, Set consists of: VARIO NITRA X Test vials VARIO NITRA NITROGEN NITRATE Reag. B Deionised water		■	■
Nitrogen, total LR	0 – 25 mg/l N	VARIO TOTAL NITROGEN LR, Set consists of a) und b): a) VARIO TOTAL NITROGEN HYDROX. LR, Set VARIO TOTAL NITROGEN HYDROX. LR, tubes VARIO TOTAL N PERSULFATE Reagent, b) VARIO TOTAL NITROGEN ACID LR/HR, Set VARIO TOTAL NITROGEN Reag. A VARIO TOTAL NITROGEN Reag. B VARIO TOTAL NITROGEN ACID LR/HR tubes Deionised water		■	■ ■ ■
Nitrogen, total HR	5 – 150 mg/l N	VARIO TOTAL NITROGEN HR, Set consists of a) und b): a) VARIO TOTAL NITROGEN HYDROX. HR, Set VARIO TOTAL NITROGEN HYDROX. HR, tubes VARIO TOTAL N PERSULFATE Reagent, b) VARIO TOTAL NITROGEN ACID LR/HR, Set VARIO TOTAL NITROGEN Reag. A VARIO TOTAL NITROGEN Reag. B VARIO TOTAL NITROGEN ACID LR/HR tubes Deionised water	■	■	■ ■ ■

devices*

Method	Applications	Quantity	Code
4-(Dimethylamino)-benzaldehyde	Water, waste water, seawater	100 ml	53 12 00
Iron, total: 1, 10-phenantroline Iron, total: TPTZ	Water, waste water, seawater Water, waste water, seawater	100 100	53 05 60 53 05 50
		1 Set	53 60 10
Fe in Mo	Water, waste water	100 100	53 03 10 53 03 20
		1 Set	53 50 90
PAN	Water, waste water	60 ml 100 60 ml	
Periodate oxidation	Water, waste water	1 Set 100 100	53 51 00
Mercaptoacetic acid	Water, waste water	1 Set 100 100	53 54 50
		1 Set	53 53 00
Mercaptoacetic acid	Water, waste water	100 100 100	
		1 Set	53 54 00
Mercaptoacetic acid	Water, waste water	100 100 100	
		1 Set	53 55 80
Chromotropic acid	Water, waste water	50 50 100 ml	
		1 Set	53 55 50
Persulfate digestion	Water, waste water	50 50 50 50 100 ml	
		1 Set	53 55 60
Persulfate digestion	Water, waste water	50 50 50 50 100 ml	



MSDS (Material Safety Data Sheets): www.lovibond.com

* HACH® is a registered trademark of Hach Company, Loveland, Colorado. The use of the HACH® trademark does not imply any affiliation with or approval by Hach Company regarding the formulation, testing or compatibility of these products for use in HACH® brand spectrophotometers or other devices or systems.

Reagents also compatible in Hach®

VARIO Powder Packs (PP) and Reagents for Photometry

Test	Range	Reagent	Liquid Reagent	Tube Tests	Powder Pack
Nitrite LR	0 – 0.3 mg/l N	VARIO NITRI3, F10 VARIO NITRI3, F25			■ ■
Phosphate	0 – 2.5 mg/l PO ₄	VARIO PHOSPHATE RGT, F10			■
Phosphate, ortho	0.06 - 5 mg/l PO ₄	VARIO REACTIVE PHOSPHATE REAGENT SET consists of: VARIO PHOSPHATE DILUTION TUBE TEST VARIO PHOSPHATE RGT, F10 Deionised water	■	■	■
Phosphate, Acid hydrolyzable and total	acid hydrolyzable: 0.02 - 1.6 mg/l P Δ 0.06 - 5 mg/l PO ₄ total: 0.02 - 1.1 mg/l P Δ 0.06 - 3.5 mg/l PO ₄	VARIO TOTAL & ACID HYDROLYZABLE PHOSPHATE REAGENT SET consists of: VARIO PHOSPHATE ACID REAG. TUBE TEST Deionised water VARIO PHOSPHATE RGT, F10 VARIO SODIUM HYDROXID 1N VARIO SODIUM HYDROXID 1,54N VARIO POTASSIUM PERSULFATE	■ ■ ■	■	■ ■ ■
Phosphate, total	0.02 - 1.1 mg/l P Δ 0.06 - 3.5 mg/l PO ₄	VARIO TOTAL PHOSPHATE REAGENT SET consists of: VARIO PHOSPHATE ACID REAG. TUBE TEST VARIO PHOSPHATE RGT, F10 Deionised water VARIO SODIUM HYDROXID 1,54N VARIO POTASSIUM PERSULFATE	■ ■	■	■ ■
Phosphonates	0.02 - 125 mg/l PO ₄	VARIO PHOSPHONATE REAGENT SET consists of: VARIO Potassium Persulfate F10 VARIO PHOSPHATE RGT, F10			■ ■
Silica, LR	0 – 1.6 mg/l SiO ₂	VARIO SILICA Reagent LR, Set F10 consists of: VARIO LR SILICA AMINO ACID F VARIO SILICA CITRIC ACID VARIO MOLYBDATE 3 Reagent solution	■		■ ■
Silica, HR	0 – 100 mg/l SiO ₂	VARIO SILICA Reagent HR, Set F10 consists of: VARIO SILICA HR MOLYBDATE, F10 VARIO SILICA HR ACID RGT, F10 VARIO SILICA CITRIC ACID, F10			■ ■ ■
Silica, UHR	0 – 200 mg/l SiO ₂	VARIO SILICA Reagent HR, Set F25 consists of: VARIO SILICA HR MOLYBDATE, F25 VARIO SILICA HR ACID RGT, F25 VARIO SILICA HR CITRIC ACID, F25			■ ■ ■
Sulphate	0 – 70 mg/l SO ₄	VARIO Sulpha 4, F10 VARIO Sulpha 4, F25			■ ■
Triazoles	1 - 16 mg/l	VARIO Triazole Rgt F25			■

devices*

Method	Applications	Quantity	Code
Diazotiation	Water, waste water	100 100	53 09 80 53 09 70
Phosphomolybdic acid/ Ascorbic acid	Water, waste water, seawater	100	53 15 50
		1 Set	53 52 00
Phosphomolybdic acid/ Ascorbic acid	Water, seawater	50 50 100 ml	
		1 Set	53 52 50
Phosphomolybdic acid/ Ascorbic acid	Water, seawater	50 50 100 ml 100 ml 100 ml 50	
		1 Set	53 52 10
Phosphomolybdic acid/ Ascorbic acid	Water, seawater	50 50 100 ml 100 ml 50	
		1 Set	53 52 20
Persulfate UV-Oxidation	Water	100 200	
		1 Set	53 56 90
Heteropoly blue	Water, seawater	100 200 2 x 50 ml	
		1 Set	53 57 00
Silicomolybdate	Water, seawater	100 100 100	
		1 Set	53 59 00
Silicomolybdate	Water, seawater	100 100 100	
USEPA accepted for waste water analysis	Water, waste water, seawater	100 100	53 21 60 53 21 50
Catalyzed UV Digestion	Water	100	53 22 00



MSDS (Material Safety Data Sheets): www.lovibond.com

* HACH® is a registered trademark of Hach Company, Loveland, Colorado. The use of the HACH® trademark does not imply any affiliation with or approval by Hach Company regarding the formulation, testing or compatibility of these products for use in HACH® brand spectrophotometers or other devices or systems.

BOD Measurement System BD 600

Accurate,
automatic and
direct control of
your wastewater
samples

Highlights

- User friendly
- Large brilliant graphic display
- Graphical representation of measured values
- USB & SD Card interface
- Mercury-free, environmentally-friendly
- Remote control
- User-selectable time span from 1 to 28 days
- Free individual programming of each of the six samples
- Inductive stirring system, 110 - 240 V / 50 - 60 Hz



Biochemical Oxygen Demand (BOD)

BOD – biochemical oxygen demand – is an expression for the quantity of oxygen required for biological degradation of organic matter in a waste water sample. BOD measurement is therefore used as a basis for the detection of biologically degradable organic matter in water. The difference between BOD and chemical oxygen demand (COD) is that COD additionally registers biologically non-degradable organic matter.

BOD measurement is therefore an important measurement of the effects of domestic and industrial waste water on sewage plants and outflow points.

Manometric, respirometric BOD measurement using the Lovibond® BD 600

The Lovibond® sensor system BD 600 is a 6 sample system that allows precise measurements of BOD based on the manometric principle. Manometric respirometers relate oxygen uptake to the change in pressure caused by oxygen consumption while maintaining a constant volume. Thanks to the modern integral pressure sensors, it is no longer necessary to use mercury for pressure measurements.

Measuring ranges and sample volumes

The BOD level of a sample depends on the quantity of organic matter present, which can vary considerably. The Lovibond® BOD measuring system BD 600 is therefore calibrated for the various sample volumes and the corresponding measuring ranges listed in the table below. The overall measuring range of the system is 0 – 4000 mg/l.

For all measuring ranges, BOD is shown directly in mg/l.

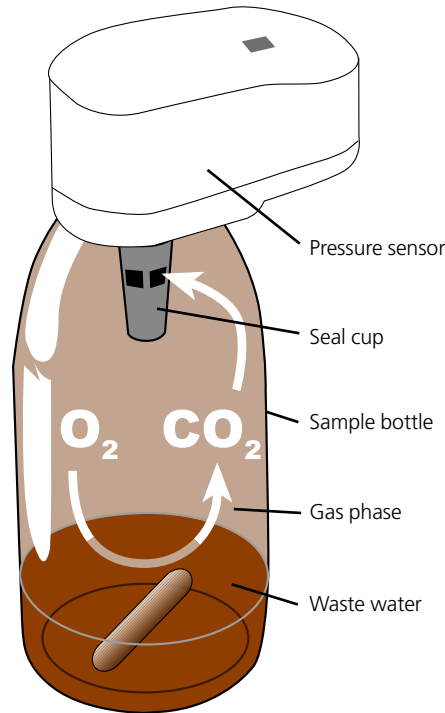

Range mg / l BOD	Sample Volume ml
0 – 40	428
0 – 80	360
0 – 200	244
0 – 400	157
0 – 800	94
0 – 2000	56
0 – 4000	21.7

BD 600 Principle

Respirometric methods provide direct measurements of the oxygen consumed by microorganisms from an air or oxygen-enriched environment in a closed vessel under conditions of constant temperature and agitation. Carbon dioxide produced metabolically by the bacteria is chemically bound by the potassium hydroxide solution contained in the seal cup in the bottle.

The result is a pressure drop in the system, which is directly proportional to the BOD value and is measured by the BOD sensor. The BOD level is then displayed directly in mg/l.

The BOD values are stored automatically in the sensor memory in regular intervals and can be called up on the large-format display at any time without the need for time-consuming conversion using factors. This means that test series that end on a Sunday can be evaluated during the following week without any problem. Measurement series can be stored on USB stick/SD card or transferred via USB cable to evaluate the data on a computer.

The measurement period is user-selectable between 1 and 28 days to suit the application. While short measurement periods are useful for scientific applications, standard BOD measurements typically extend over a period of 5 days – and manometric determination of OECD, for example, generally takes place over a period of 28 days.



Applications

- Waste Water
- Determination of Biological Activity
- Waste Water Treatment Plants
- Analytical Laboratories
- Science & Research

References

- APHA, AWWA, WEF Standard Methods 5210 D
- H55 as a supplement to EN 1899-2

Day	Display
1. Day	150 mg/l
2. Day	220 mg/l
3. Day	240 mg/l
4. Day	250 mg/l
5. Day	260 mg/l

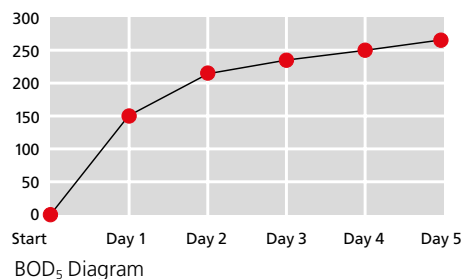

BOD accessories

Evaluation of measurements

The BD 600 measuring system records a measurement once every hour, independent of the length of the measuring period. This way the quality of the series of measurement can be evaluated in an early stage. Current values and stored values may be called up at any time. Stored value can be displayed numerically or graphically. The table/graph on the left illustrates an example of BOD₅ evaluation. The development of BOD over a period of five days is easily seen.

Automatic start function

Variations in sample temperature prior to testing result in pressure variations within the measuring system during the temperature equalisation period in the thermostatically controlled cabinet (if BOD measurement is to take place at 20°C, for example). Such variations would normally cause errors during manometric measurement. In order to prevent such errors, the Lovibond® BD 600 BOD meter is equipped with an automatic start feature: measurement does not commence until the temperature in the samples is the same as that in the thermostatically controlled cabinet. This rules out the possibility of temperature (and hence pressure) fluctuations that are not related to the manometric measurement.

The complete BD 600 measuring system

In addition to the BOD unit for measurement and storage of BOD levels, the Lovibond® BD 600 BOD measuring system includes sample bottles, measuring sensors, non-wearing inductive stirring system, overflow measuring flasks for metering of sample volumes, nitrification inhibitor and potassium hydroxide as an absorbent.

Technical data

Meas. principle	Manometric; mercury-free; electronic pressure sensor
Ranges [mg/l O₂]	0 - 40, 0 - 80, 0 - 200, 0 - 400, 0 - 800, 0 - 2000, 0 - 4000 mg/l
Applications	BOD ₅ , BOD ₇ , OECD 301 F ...
Display	128 x 240 pixel, 45 x 84 mm, backlit
Measurement period	User-selectable, between 1 and 28 days
Auto result storage	Up to 672 results, depending on measurement period
Storage interval	– hourly (1 day) – every 2 hours (2 days) – daily (3-28 days)
Automatic start function	– After temperature equalisation of samples – Can be switched off
Power supply	3 alkaline-manganese batteries ("Baby" cells/size "C") or via power supply unit using y-cable together with stirring unit
Interface	USB host port (USB stick) USB device port (computer) SD card
Clock	Real-time clock
Protection class	IP 54 (sensor head)
Dimensions (L x W x H)	375 x 181 x 230 mm including stirring unit
Weight	4100 g, unit with bottles & batteries 5775 g, complete with stirring unit
Housing	ABS
Approval	CE

Delivery Content BD 600

- BD 600, complete unit with 6 sensor heads and control unit with batteries
- Power supply unit incl. Y-cable for common power supply of BD 600 and stirring unit
- 1 x USB-cable
- 1 x remote control
- Inductive stirring unit
- 6 sample bottles
- 6 rubber gaskets
- 6 magnetic stirring rods
- 1 overflow flask, 157 ml
- 1 overflow flask, 428 ml
- 1 bottle, 50 ml potassium hydroxide solution
- 1 bottle, 50 ml nitrification inhibitor solution
- 1 instruction

Order code: 2 44 44 60

Delivery Content BD 606

- 2 x BD 600, complete unit each with 6 sensor heads and control unit with batteries
- 2 x power supply unit incl. Y-cable for common power supply of BD 600 and stirring unit
- 2 x USB-Kabel
- 1 x remote control
- 2 x Inductive stirring unit
- 12 sample bottles
- 12 rubber gaskets
- 12 magnetic stirring rods
- 1 overflow flask, 157 ml
- 1 overflow flask, 428 ml
- 1 bottle, 50 ml potassium hydroxide solution
- 1 bottle, 50 ml nitrification inhibitor solution
- 1 instruction

Order code: 2 44 44 65



Remote control

Accessories

Item	Order code
Sensor head	2 44 44 70
BOD sample bottle Brown glass, 500 ml	41 86 44
BOD sample bottles , Brown glass, 500 ml, set of 6 bottles	41 86 45
Inductive stirring system for 6 samples, 100-240 V / 50-60 Hz, incl. power supply	2 44 44 56
Power supply unit for inductive stirring system , 100 - 240 V / 50 - 60 Hz	44 44 54
Stirring rod	41 86 33
Stirring rod remover	41 86 38
Rubber gasket	41 86 36
Chemicals:	
Potassium hydroxide solution 45 %, 50 ml	2 41 86 34
Nitrification inhibitor (N-ATH) 50 ml	2 41 86 42
Overflow flask , 21.7 ml	41 86 64
Overflow flask , 56 ml	41 86 55
Overflow flask , 94 ml	41 86 56
Overflow flask , 157 ml	41 86 57
Overflow flask , 244 ml	41 86 58
Overflow flask , 360 ml	41 86 59
Overflow flask , 428 ml	41 86 60
Complete set overflow flasks	41 86 54
Test set , BOD CM test tablets, box with 10 tablets	2 41 83 28
USB-cable, length 3 meter	2 44 44 82
Y-cable	2 44 44 75
Remote control	2 44 44 81

Test set for BD 600

We also supply a test set to check for correct operation of the Lovibond® BD 600 BOD meter. The set contains 10 BOD CM1 test tablets that cause a defined oxygen consumption.

The tablets are easy to use. Simply place a tablet in the BOD bottle, start the measurement process, read off the BOD value after 5 days, and then compare with the defined value. If this value is within the quoted tolerance, this means that the BOD measuring system is functioning correctly.



BOD CM test tablets, order code: 2 41 83 28

Temperature equalisation during BOD measurement

Temperature equalisation is essential prior to biological testing, as temperature has a major effect on biological activity. BOD measurements, for example, are always performed in a thermostatically controlled cabinet at a temperature of 20°C.

For temperature equalisation, we recommend Lovibond® thermostatically controlled cabinets with a user-selectable temperature from 2°C to 40°C.

Inductive stirring system



Inductive stirring system

The microprocessor-controlled Lovibond® inductive stirring system is non-wearing and maintenance-free. In other words, there are no moving parts in the system.

At regular intervals, the magnetic stirring rods are accelerated and slowed down again, taking them up to maximum speed and back down again. This ensures the centralization of the stirring rods.

Stirring rods that move away from the centre of the bottle are re-centered quickly and reliably.

The inductive actuation system guarantees maintenance-free operation (no need to replace drive belts or burnt-out drive motors) for many years.

Highlights

- Maintenance-free and non-wearing
- Regular change in stirring speed
- Automatic centering of stirring rods
- No mechanical components in the stirring system

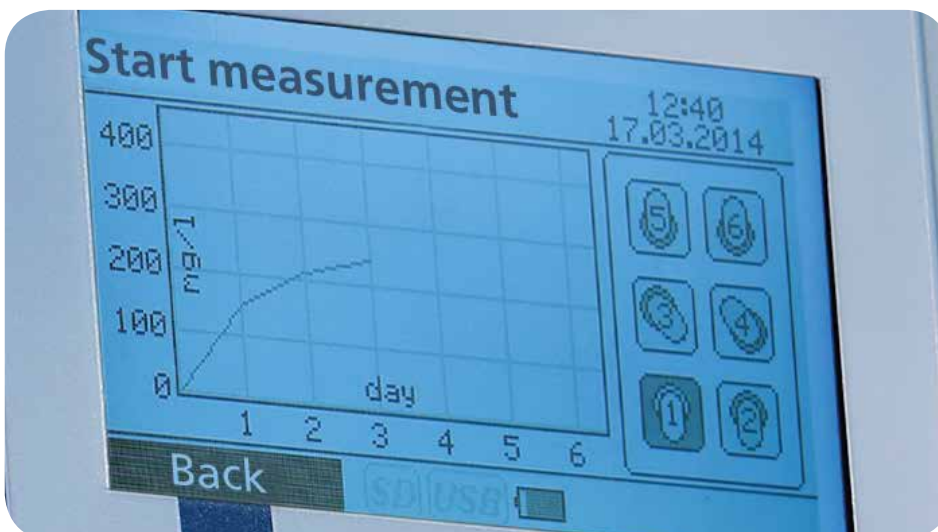

Graphical representation of measured values

Thermostatically controlled incubators - TC series



The TC series of thermostatically controlled cabinets is used for continuous temperature control over a range of 2 °C to 40 °C. This makes them ideal for a wide range of different applications in industrial and research laboratories.

In particular they are ideal for the temperature-controlled storage of samples or BOD determination in effluent analysis work.

The temperature can be set in steps of 0.1 °C and an LED display shows both the set temperature and the current temperature in the cabinets.

Devices such as magnetic agitators, which require a power supply, can be connected to sockets incorporated in the interior of the cabinet.

The integral temperature control unit meets the requirements of the EMC directive issued as IEC 61326: "Electrical devices for measurement, monitoring and for use in laboratories".

Improved, robust, insulated housing and highly efficient components provide maximum energy efficiency.

There are 4 models available with standard doors from 135 to 445 litres net capacity, and 2 models with glass doors with 140 and 255 litres net capacity.

Standard or glass door - lockable

Highlights

- Temperature range 2 °C to 40 °C, continuously adjustable in steps of 0.1 °C
- Low power consumption
- Illuminated LED display of preset and current temperatures
- Ideal for BOD determination at 20 °C
- Power sockets inside the incubator
- 6 models in 4 sizes
- Standard door or glass door

Applications

- BOD-Measurement
- Microbiological Research
- Food Industry
- Dairies
- Laboratories
- Research Centres
- Universities

Models with standard door

TC 135 S

3 metal racks + 1 bottom grid + 4 sockets

Consumption: approx. 1.35 kWh / 24 h*

I. D. (approx.): 513 W x 441 D x 702 H mm

Net capacity: approx. 135 l

O. D. (approx.):

600 W x 600 D x 850 H mm with work top

600 W x 600 D x 819 H mm without work top

Suitable for built under applications

Weight: approx. 39.0 kg

Order code: 2 43 82 00

TC 175 S

3 metal racks + 1 bottom grid + 5 sockets

Consumption: approx. 1.23 kWh / 24 h*

I. D. (approx.): 470 W x 440 D x 1062 H mm

Net capacity: approx. 175 l

O. D. (approx.): 600 W x 610 D x 1250 H x mm

Weight: approx. 51.0 kg

Order code: 2 43 82 20

* Ambient temperature 25 °C

Target temperature 20 °C

Variations possible

Models with standard door

TC 255 S

4 metal racks + 1 bottom grid + 7 sockets

Consumption: approx. 1.54 kWh / 24 h*

I. D. (approx.): 470 W x 440 D x 1452 H mm

Net capacity: approx. 255 l

O. D. (approx.):

600 W x 610 D x 1640 H x mm

Weight: approx. 61.0 kg

Order code: 2 43 82 30

TC 445 S

4 metal racks + 1 bottom grid + 9 sockets

Consumption: approx. 1.42 kWh / 24 h*

I. D. (approx.): 600 W x 560 D x 1452 H mm

Net capacity: approx. 445 l

O. D. (approx.): 750 W x 730 D x 1640 H x mm

Weight: approx. 78.5 kg

Order code: 2 43 82 40

* Ambient temperature 25 °C

Target temperature 20 °C

Variations possible

Models with glass door

TC 140 G

3 metal racks + 1 bottom grid + 4 sockets

Consumption: approx. 1.77 kWh / 24 h**

I. D. (approx.): 513 W x 441 D x 702 H mm

Net capacity: approx. 140 l

O. D. (approx.):

600 W x 600 D x 850 H x mm with work top

600 W x 600 D x 819 H mm without work top

Suitable for built under applications

Weight: approx. 48.0 kg

Order code: 2 43 82 10

TC 256 G

4 metal racks + 1 bottom grid + 7 sockets

Consumption: approx. 1.56 kWh / 24 h**

I. D. (approx.): 470 W x 440 D x 1452 H mm

Net capacity: approx. 255 l

O. D. (approx.): 600 W x 610 D x 1640 H x mm

Weight: approx. 77.0 kg

Order code: 2 43 82 35

** Ambient temperature 25 °C

Target temperature 20 °C

with interior lighting switched on (15 W)

Variations possible

Technical Data

Design	Fully insulated cabinet with universal temperature control unit	Temperature tolerance	± 1 °C, specified for a stirred 500 ml water sample. For BOD (T=20 °C ±0,5 °C)
Lock	existing	Display	Backlit LED display Resolution 0.1 °C
Models with glass door	Insulating glass door in an ABS frame. ceiling lighting, separately switchable	Fan	Axial, output 320 m³/h
Operation	Splash-proofed keypad, 2 buttons with tactile feedback	Cooling/Heating	Integrated powerful cooling and heating
Control range	+ 2 °C to + 40 °C, steps of 0.1 °C	Power supply	220 - 240 V / 50 Hz
Climate class	+ 10 °C to + 32 °C,	Sockets	CEE 7/5, type E with hinged lid, 230 V / 16 A 2p + E, IP 44
		Coolant	R134a
		Approval	CE

Space for BD 600 systems

Model	Systems, standard ¹⁾	Systems, comfort ²⁾
TC 135 S / TC 140 G	3	2
TC 175 S	5	2
TC 255 S / TC 256 G	7	3
TC 445 S	12	9

¹⁾ Change of bottles **by** removing racks.

²⁾ Change of bottles **without** removing racks.

Temperature control unit

The temperature control unit fulfills the EMC requirements according IEC 61326 : Electrical equipment for measurement, control and laboratory use.



Spark-free cabinets - EX series



Contents not supplied

The German guidelines „Working Safely in Laboratories BG-I 850-0“ stipulates that interior spaces must be explosion-protected where hazardous, explosive atmospheres can develop (for example, due to the presence of flammable liquids).

The Lovibond® cabinets in the EX range meet the requirements of these guidelines and are fully equipped for daily laboratory use.

The cabinet consists of a sturdy sheet steel housing with impact-proof and jolt-resistant powder coating. Improved, robust, insulated housing and highly efficient components provide maximum energy efficiency.

The robust interior is made of high-quality, strong white plastic material (PS).

The door is lockable and supplied with a right-hand hinge as standard (but can easily be converted to a left-hand hinge). A tight door seal is ensured by an all-round magnetic gasket.

The temperature in the refrigerator can be continuously adjusted over the range +1°C to +15°C; a room thermostat ensures constant control. The digital temperature display enables the interior temperature to be easily read. The high performance fan provides for an even temperature distribution inside.

The models EX 220, EX 300 and EX 490 have a “fan stop” function, which switches the fan off when the door is opened.

Laboratory cabinets with a spark-free interior

Highlights

- Spark-free according to BG-I 850-0
- Dynamic cooling system
- 1 °C to 15 °C, continuously adjustable
- Digital temperature display
- High energy efficiency
- Robust materials
- Lockable

Applications

- Laboratories
- Research Centres
- Universities

EX 160

220 - 240 V ~ / 1 A

Consumption: 0.898 kWh / 24 h

Temperature regulation: continuous 1 °C to 15 °C

Lockable door, changeable door stop

4 storage levels (3 height-adjustable glass shelves)

I. D. (approx.): 513 W x 441 D x 702 H mm

Net capacity: approx. 160 l

O. D. (approx.): 600 W x 600 D x 860 H x mm

Weight: approx. 41.0 kg

Order code: 2 42 21 05



EX 220

220 - 240 V ~ / 1 A

Consumption: 0.786 kWh / 24 h

Temperature regulation: continuous 1 °C to 15 °C

Lockable door, changeable door stop

5 storage levels (4 height-adjustable glass shelves)

I. D. (approx.): 470 W x 440 D x 1062 H mm

Net capacity: approx. 220 l

O. D. (approx.): 600 W x 610 D x 1250 H x mm

Weight: approx. 53.0 kg

Order code: 2 42 21 15



EX 300

220 - 240 V ~ / 1.5 A

Consumption: 0.947 kWh / 24 h

Temperature regulation: continuous 1 °C to 15 °C

Lockable door, changeable door stop

6 storage levels (5 height-adjustable glass shelves)

I. D. (approx.): 470 W x 440 D x 1452 H mm

Net capacity: approx. 300 l

O. D. (approx.): 600 W x 610 D x 1640 H mm

Weight: approx. 64.0 kg

Order code: 2 42 21 25



EX 490

220 - 240 V ~ / 1,5 A

Consumption: 0.983 kWh / 24 h

Temperature regulation: continuous 1 °C to 15 °C

Lockable door, changeable door stop

6 storage levels (5 height-adjustable glass shelves)

I. D. (approx.): 600 W x 560 D x 1452 H mm

Net capacity: approx. 490 l

O. D. (approx.): 750 W x 730 D x 1640 H mm

Weight: approx. 84.0 kg

Order code: 2 42 21 35



Technical data

Cooling	Powerful compressor unit, mounted on low noise, vibration-free bearings
Coolant	R600a
Defrost	Automatic defrost - condensation drains into a collection bowl within the refrigerator
Temperature	1 °C to 15 °C
Climate class	EX 160: SN, 10 °C to 32 °C EX 220, EX 300, EX 490: SN-T, 10 °C to 43 °C
Lock	existing
Power supply	220 - 240 V / 50 Hz
Height adjustment	Adjustable front feet
Approval	CE
EX-safety	Spark-free interior

The product complies with the following european directives and regulations: 2006/42/EC, 2006/95/EC, 94/9/EC, 2004/108/EC, 2011/65/EU.

Spares

Safety- and collecting tub (PP) for EX 160
Order code: 42 21 55

Safety- and collecting tub (PP) for EX 220, 300
Order code: 42 21 56

Safety- and collecting tub (PP) for EX 490
Order code: 42 21 57

Glass shelves for EX 160
Order code: 42 21 65

Glass shelves for EX 220, 300
Order code: 42 21 66

Glass shelves for EX 490
Order code: 42 21 67

SD 300 pH

SD 310 Oxi

SD 320 Con



Waterproof
Hand-held Meters for
the determination of
pH/Redox/Temperature

Conductivity, TDS,
Salinity, Temperature

Dissolved oxygen (O₂)
O₂-Concentration
O₂-Saturation
Temperature

Highlights

- Rugged, water resistant (IP 67) designed for field use
- PC interface (USB / serial or analog)
- Automatic buffer detection (SD 300 pH)
- Data logger and alarm function (min./max.)
- Good Laboratory Practice (GLP-features)
- Clear, concise result reading: easy-to-read backlit LCD display
- Automatic temperature compensation
- High resolution (0.001 pH / 0.1 mV) (SD 300 pH)
- Dirt-insensitive up-to-date 4-pole conductivity cell offering highest precision (SD 320 Con)

Applications

- Drinking Water
- Cooling/Boiler Water
- Waste Water
- Pool Water
- Surface Water

Features SD 300 pH

Min / Max Value Memory

highest and lowest measured value is saved.

Auto Hold

freeze and display measurement.

Auto Power Off

if unused, the meter automatically switches off after a selected period (0 to 120 min, or deactivated)

Additional Display for pH Electrode and Battery

Bar graph display

Low Battery Display

"BAT"

Automatic Temperature Compensation

Automatic Temperature Compensation (ATC) in pH mode (in the range of 0 - 105 °C) when the temperature probe is connected.

Temperature can be input manually, when the temperature probe is not attached.

pH Calibration

Automatic Buffer Recognition.

Permissible electrodes data: Asymmetry:

± 55 mV / Slope: 45 ... 62 mV/pH

The condition of pH Electrode is checked at each calibration.

1, 2 or 3 point calibration with Lovibond® Standard Buffer, DIN 19266 Buffer or any manually entered Buffer values.

Redox Measurement (ORP)

2 options:

"mV" Standard Redox or mV measurement

"mVH" Conversion to hydrogen systems according to DIN38404 Part 6

rH Measurement

The rH value is calculated from a measured Redox value and a manually input pH value

Features SD 310 Oxi

Measurement of:

Oxygen partial pressure, Oxygen Concentration, Oxygen Saturation, Temperature measurement

Automatic absolute air pressure measurement

Auto Hold Function

Alarm Function

Data Logger + Software

Easy calibration against oxygen in air

Salinity correction

Self-polarising galvanic oxygen probe,

allows instant measurement after system is switched on

Low battery and battery change indicator

Sensor evaluation

after calibration in the display

Shock-absorbing rubber protective armouring

Waterproof IP 65 and IP 67

Features SD 320 Con

Min / Max Value Memory

highest and lowest measured value is saved

Auto Hold

freeze and display measurement

Auto Power Off

if unused, the meter automatically switches off after a selected period (0 to 120 min, or deactivated)

Low Battery Display

"BAT"

Automatic temperature compensation

As conductivity depends strongly on temperature, each conductivity value is only valid at the corresponding temperature.

Therefore the device supports temperature compensation, i.e. referring the conductivity to a reference temperature (selectable: 20 °C or 25 °C).

Salinity measurement

Salinity means the sum of amount of all dissolved salts in water.

The unit is g / kg.

TDS measurement (total dissolved solids)

TDS means the mass concentration of dissolved media in a liquid. The unit is mg/l.



SD 300 pH in case



SD 310 Oxi in case



SD 320 Con in case

SD 300 pH

SD 310 Oxi

Accessories

Code	Article
721231	pH/temp.-electrode type 231 plastic/gel/temperature NTC30kOhm (SET 1)
721226	pH-electrode plastic/gel-type 226 (SET 2)
721235BNC	pH-electrode glass/gel-type 235
721240BNC	Redox-electrode plastic-type 240
72 12 45	PT1000Temperature sensor (SET 2)
41 86 09	KCl-solution, 3 molar saturated with AgCl, 100 ml
72 12 50	pH buffer-set 4.00/7.00/10.00 (25 °C)
72 12 52	pH buffer 4.00 (25 °C) 1 litre
72 12 54	pH buffer 7.00 (25 °C) 1 litre
72 12 56	pH buffer 10.00 (25 °C) 1 litre
19 50 70	Redox calibration solution, 470 mV, 100 ml
72 46 20	USB cable, for connection to a computer
72 46 25	GSOFT 3050 data transmission software with logger for setting, reading and printing of stored data
72 50 60	Case with foam inlet

Delivery Content

Order Code: 72 46 00

SD 300 pH

without electrode, with batteries, protective armouring, instruction manual, warranty information

Order Code: 72 46 10

SD 300 pH (SET 1)

instrument, batteries, pH/temp. plastic-electrode type 231, pH-buffer-set (pH 4.00/7.00/10.00), in case, manual, warranty information

Order Code: 72 46 11

SD 300 pH (SET 2)

as SET 1, but with pH / temperature plastic-electrode type 226, temperature sensor Pt 1000, manual, warranty information

Technical Data

Measuring ranges

pH	- 2.000 ... 16.000 pH
Redox / mV	- 1999.9 ... 1999.9 mV
Temperature	- 10.0 ... + 110.0 °C + 14.0 ... + 230.0 °F
rH	0.0 ... 70.0 rH

Accuracy

pH	± 0.005 pH
Redox / mV	± 0.05 % FS (mV or mVH)
Temperature	± 0.2 °C - 5.0 ... + 100.0 °C)
rH	± 0.1 rH

Connections

pH, Redox	BNC female connector, compatible to standard BNC plugs and waterproof BNC plugs, additional banana-jack (4 mm) for separate reference electrode input resistance: 10 ¹² Ohm
Temperature	2 banana jacks (4 mm) for temperature probe (Pt1000 or NTC 30K)

Interface / Supply	4-pole bayonet connector for serial interface and supply (with accessory USB 300)
---------------------------	---

Display	two 4.5 - digit seven-segment display (15 mm and 12 mm)
----------------	---

pH Calibration

Automatically	1, 2 or 3 point calibration, Lovibond® Standard Buffer or Buffer to DIN19266
----------------------	--

Manually	1, 2 or 3 point calibration
-----------------	-----------------------------

Protection class	IP67 (housing and connections)
-------------------------	--------------------------------

Dimensions	164 x 128 x 37 mm (H x W x D) incl. protection cover
-------------------	--

Weight	250 g incl. battery and protective armouring
---------------	--

Housing	impact resistant PA 6 G B30 housing with pop-up clip
----------------	--

Armouring	Shock-absorbing protective armouring
------------------	--------------------------------------

Power supply	2 x AAA-battery (included) power consumption: 2.0 mA
---------------------	--

Battery life	500 hours
---------------------	-----------

CE-Conformity	
----------------------	--

Technical Data

O₂ concentration	0.0 ... 70.0 mg/l
O₂ partial pressure	0 ... 1200 hPa O ₂ 0.0 ... 427.5 mm Hg
O₂ saturation	0 ... 600 %
Ambient air pressure	10...1.200 hPa abs.
Sensor temperature	- 5 ... 50 °C = 23 ... 122 °F
Accuracy O₂ concentration	0 ... 25 mg/l ± 1.5 % ± 0.2 mg/l 25 ... 70 mg/l ± 2.5 % ± 0.3 mg/l
Temperature accuracy	± 0.1 °C
Ambient air pressure accuracy	3 hPa bzw. 0.1 % full scale (higher value relevant)
Ambient conditions sensor	0 to 40 °C = 32 to 104 °F 0 to 95 % relative density (non-condensing)
Storage temperature	Instrument: - 25 ... 70 °C = - 13 ... 158 °F Sensor: 0 ... 40 °C = 32 ... 104 °F
Nominal temperature	25 °C
Display	Backlit LCD
Data storage	1,000 data sets manually 8,000 data sets cyclically
Power supply	2 x AAA Batteries
Dimensions	164 x 98 x 37 mm (H x W x D) protective armouring
Weight	287 g incl. batteries and protective armouring
Power consumption	6.25 mA (with Out = Off, corresponding to 160 h), backlight: 10 mA (switches off automatically)
Auto-Off	0 - 120 minutes
Electrode connection	7-pin bayonet connection. Interface/ ext. supply: 4-pin bayonet connection for serial interface and supply
CE-Conformity	

SD 320 Con

Accessories

Code	Article
19805050	Oxygen sensor with 1.5 m cable, platinum cathode / Lead anode
19805051	Oxygen sensor with 10 m cable, platinum cathode / Lead anode
19805052	Oxygen sensor with 30 m cable, platinum cathode / Lead anode
724670	Service Set for oxygen sensor consisting of 3 pcs. spare membrane heads and 100 ml KOH (1.18 mol/l) electrolyte solution
19805055	Protection cap for oxygen sensor for depth measurement (PVC)
19805056	Protection cap for oxygen sensor for depth measurement (brass)
724620	USB cable, for connection to a computer
725020	Case with foam inlet

Delivery Content

Order Code: 72 46 50
SD 310 Oxi (SET 1)
 instrument, batteries, oxygen sensor with 1.5 m cable, electrolyte solution (KOH) 30 ml and 2 pcs. spare membrane heads, instruction manual, warranty information

Order Code: 72 46 60
SD 310 Oxi (SET 1)
 as SET 1, but with oxygen sensor with 10 m cable, electrolyte solution (KOH) 30 ml and 2 pcs. spare membrane heads, instruction manual, warranty information

Order Code: 72 46 65
SD 310 Oxi (SET 2)
 as SET 1, but with oxygen sensor with 30 m cable, electrolyte solution (KOH) 30 ml and 2 pcs. spare membrane heads, instruction manual, warranty information

Technical Data

Measuring ranges

Number	5
Smallest range	0.000 ... 5.000 $\mu\text{S} / \text{cm}^*$ or 0.0 ... 500.0 $\mu\text{S} / \text{cm}^{**}$
Biggest range	0 ... 5000 $\mu\text{S} / \text{cm}^*$ or 0 ... 1000 $\text{mS} / \text{cm}^{**}$
Resistivity	0.005 ... 500.0 $\text{k}\Omega\text{m} / \text{cm}$ (depends on cell constant)
TDS	0 ... 5000 mg/l (depends on cell constant)
Salinity	0.0 ... 70.0 (g salt / kg water equals PSU = Practical Salinity Unit)
Temperature	- 5.0 ... + 150.0 $^{\circ}\text{C}$, Pt1000 or NTC (10 $\text{k}\Omega\text{m}$)
Supported cell constants	4.000 ... 15.000 cm^{-1} 0.4000 ... 1.5000 cm^{-1} 0.04000 ... 0.15000 cm^{-1} 0.004000 ... 0.015000 cm^{-1}

Accuracy

Conductivity	$\pm 0.5\%$ of reading $\pm 0.1\%$ FS (depends on electrode)
Temperature	$\pm 0.2\text{ }^{\circ}\text{C}$ (- 5.0 ... + 100.0 $^{\circ}\text{C}$)

Connection

Conductivity, Temperature	1 x 7 pole bayonet connector for connection of different measuring cells
Supported temperature sensors	Pt1000 or NTC (10k)
Interface / ext. supply	4-pole bayonet connector for serial interface and supply (with accessory USB 300)
Display	two 4.5 - digit seven-segment display (15 mm and 12 mm)
Protection class	IP67 (housing and connections)
Dimensions	164 x 128 x 37 mm (W x H x D) incl. protection cover
Weight	250 g incl. battery and protective armouring
Housing	impact resistant PA 6 G B30 housing with pop-up clip
Power supply	2 x AAA-battery (included) power consumption: < 6,25 mA
Battery life	160 hours
CE-Conformity	

depends on cell constant of used electrode
 * cell constant 0.01 / cm
 ** cell constant 0.1 ... 1.2 / cm

Accessories

Code	Article
19805040	Conductivity cell LC 12, measuring range 0 - 200 mS/cm
19805045	Conductivity cell LC 16, measuring range 0 - 1000 mS/cm
72 22 50	Calibration solution 1413 $\mu\text{S/cm}$
72 46 20	USB cable, for connection to a computer
72 46 25	GSOFT 3050 data transmission software with logger for setting, reading and printing of stored data
72 50 60	Case with foam inlet

Delivery Content

Order Code: 72 47 00
SD 320 Con (SET 1)
 instrument, batteries, conductivity cell LC 12 (measuring range 0 - 200 mS/cm), manual, warranty information in case

Order Code: 72 47 20
SD 320 Con (SET 2)
 instrument, batteries, conductivity cell LC 16 (measuring range 0 - 1000 mS/cm), manual, warranty information in case

SensoDirect 150

pH value

Redox

Oxygen (dissolved)

Conductivity

TDS

Temperature (°C/°F)



All in one Hand-held Meter

Highlights

- pH/Redox
Conductivity
Dissolved Oxygen etc.
- All in one
- Real time data logger
- Large digital display
- Protective casing
- RS 232 / USB

Applications

- Drinking Water
- Cooling/Boiler Water
- Waste Water
- Pool Water
- Surface Water
- Water Treatment Companies
- Industrial and Governmental
Laboratories

The SensoDirect 150 combines the features of several hand-held meters. It is designed for multi purpose operation and measures pH/Redox, dissolved oxygen and conductivity/TDS.

The SensoDirect 150 incorporates an intuitive user interface, large, easy to read display and is supplied with a sturdy handy case with electrodes, buffer solution and accessories.

Accessories

Code	Article
721330	Spare electrode, (approx. 1 m cable), plastic/gel type BNC-plug
721250	pH buffer set 4.00/7.00/10.00 (25 °C)
721247	pH buffer, 4.00 (25 °C), 90 ml
721248	pH buffer, 7.00 (25 °C), 90 ml
721249	pH buffer, 10.00 (25 °C), 90 ml
721252	pH buffer 4.00 (25 °C) 1 litre
721254	pH buffer 7.00 (25 °C) 1 litre
721256	pH buffer 10.00 (25 °C) 1 litre
721242	Redox electrode, (approx. 1 m cable), plastic/gel type BNC-plug
195070	Redox calibration solution, 470 mV, 100 ml
724400	Conductivity probe (Con / TDS), (approx. 1.2 m cable)
722250	Calibration solution 1413 µS/cm
724410	Oxygen sensor, (approx. 4 m cable)
724460	Spare membrane for oxygen sensor
724470	Spare electrolyte for oxygen sensor
724420	Temperature probe PT1000 (approx. 1.5 m cable)
724500	RS232 cable, for connection to a computer
724510	USB cable, for connection to a computer
724540	Power supply
725050	Case incl. foam
724520	Data Retrieve Software Software which enables the user to transmit data stored on the instrument to a computer
724530	Data Logger / Acquisition Software Software which enables the user to monitor and log data on a computer (online measurement)

SensoDirect 150

Display	Large LCD display with contrast adjustment
Data Logger	Real time data logger
Data Memory	Auto or manual data memory, 16000 data sets
Data Hold	Max, Min
Interface	USB, RS232
Probes	pH, ORP, Conductivity/TDS, Dissolved Oxygen and Temperature
Power off	Auto shut off or manual off
Data Output	RS 232 PC serial interface
Power Supply	DC 1,5 V battery (UM3, AA) x 4 PCs or DC 9V adapter in
Dimensions	220 x 120 x 40 mm (L x W x H)
Weight	approx. 625 g (unit incl. batteries)
Software	Data acquisition software Data logger software

CE-Conformity

pH/Redox

Range	pH 0 to 14 PH mV -1999 mV to 1999 mV
Resolution	0 - 14 pH, 0.01 pH 0 - 1999 mV, 1 mV
Accuracy	0 - 14 pH, ± 0.02 pH + 2 digits 0 - 1999 mV, ± 0.5 % + 2 digits
Temperature Compensation	manual 0 - 100 °C automatic (ATC)
pH Calibration	pH 7, pH 4, and pH10, 3 points calibration

Dissolved Oxygen

Range	Dissolved Oxygen 0 to 20.0 mg/l Oxygen in Air 0 to 100.0 % Temperature 0 to 50 °C
Resolution	Dissolved Oxygen 0.1 mg/l 0.1 % O ₂ Temperature 0.1 °C
Accuracy (23± 5 °C)	Dissolved Oxygen ± 0.4 mg/l Oxygen in Air ± 0.7% O ₂ Temperature ± 0.8 °C / 1.5 °F
Salinity Correction	0 to 39 % Salt
Air Pressure Compensation	0 to 8900 meter

Conductivity/TDS

Range/Resolution	Conductivity (µS, mS) 0 - 200.0 µS / 0.1 µS 0.2 - 2.000 mS / 0.001 mS 2 - 20.00 mS / 0.01 mS 20 - 200.00 mS / 0.1 mS
	TDS (Total Dissolved Solids) 0 - 132 ppm / 0.1 ppm 132 - 1,320 ppm / 1 ppm 1,320 - 13,200 ppm / 10 ppm 13,200 - 132,000 ppm / 100 ppm
	Temperature 0 - 60 °C / 0.1 °C 32 - 140 °F / 0.1 °F
Accuracy	± 2 % F.S. + 1 digit ± 0.8 °C / ± 1.5 °F
Function	Conductivity (µS, mS) TDS (Total Dissolved Solids, PPM) Temperature (°C, °F)

Delivery Content

Order Code: 724200

SensoDirect 150 Set pH/Con/TDS/Oxi instrument, batteries, pH electrode, temperature probe, conductivity probe, oxygen sensor, pH buffer set 4,00 / 7,00, electrolyte, membrane heads, instruction manual, warranty information, in case

Order Code: 724210

SensoDirect 150 Set pH / Con / TDS instrument, batteries, pH electrode, temperature probe, conductivity probe, pH buffer set 4,00 / 7,00, instruction manual, warranty information, in case

Order Code: 724220

SensoDirect 150 Set pH / Oxi instrument, batteries, pH electrode, temperature probe, oxygen sensor, pH buffer set 4,00 / 7,00, electrolyte, membrane heads, instruction manual, warranty information, in case

Order Code: 724230

SensoDirect 150 Set pH / Redox instrument, batteries, pH electrode, temperature probe, redox electrode, pH buffer set 4,00 / 7,00, instruction manual, warranty information, in case

SensoDirect 110



Determination of
pH
Conductivity
Salinity

Highlights

- High measuring accuracy
- Light weight
- Protective casing
- Large digital display
- "Low battery" indicator
- Two-Point Calibration

Applications

- Drinking Water
- Cooling/Boiler Water
- Waste Water
- Pool Water
- Surface Water
- Water Treatment Companies
- Industrial and Governmental Laboratories

pH110

The SensoDirect pH110 is a high quality, portable, battery operated pH meter. The instrument is equipped as standard with protective casing and built-in electrode holder.

The gel electrode of the SensoDirect pH110 is temperature resistant over the range 0 - 80 °C. It is fitted with a BNC connector as standard.

Technical data pH110

Range	0 - 14 pH
Resolution	0.01 pH
Accuracy	± 0.07 pH (pH5-pH9) ± 0.1 pH (pH4-pH10) ± 0.2 pH (pH1-pH3.9) ± 0.2 pH (pH10,1-pH13) 23 ± 5 °C, after calibration
Ambient conditions	0 - 50 °C 0 - 80 % rel. humidity (non condensing)
Battery	9 V block
Dimensions	208 x 110 x 34 mm (L x W x H)
Weight	approx. 380 g
CE-Conformity	
Order Code	72 13 00



Accessories SensoDirect pH110

Code	Article
721330	pH-electrode plastic/gel, type pH110
721247	pH-buffer, 4.00 (25°C), 90 ml
721248	pH-buffer, 7.00 (25°C), 90 ml
721249	pH-buffer, 10.00 (25°C), 90 ml

Delivery Content

- SensoDirect pH110 in a sturdy plastic case
- Battery
- pH buffer (4.00/7.00)
- pH plastic electrode-type 110
- Warranty information
- Instruction manual

Con110

The SensoDirect Con110 is a compact and versatile meter. The unit is extremely easy to use and is equipped as standard with a protective casing and built-in electrode holder.

It is equipped with a LC display showing two or three decimal places and a measuring range either of 0.001 - 1.999 or 0.01 - 19.99 mS/cm.

As conductivity measurement also depends on temperature, the SensoDirect Con110 includes an automatic temperature compensation feature.

The SensoDirect Con110 can be calibrated and adjusted using a potentiometer.



Technical data Con110

Range	0.001 - 1.999 mS/cm 0.01 - 19.99 mS/cm
Resolution	0.001 / 0.01 mS/cm
Temperature compensation	0 - 100 °C automatically 2 %/K, 25 °C
Accuracy	± 3 % Full Scale ± 1 Digit (23 ± 5 °C)
Ambient conditions	0 - 50 °C 0 - 80 % rel. humidity (non condensing)
Battery	9 V-Block
Dimensions	208 x 110 x 34 mm (L x W x H)
Weight	approx. 380 g
CE-Conformity	
Order code	72 23 00

Accessories SensoDirect Con110

Code	Article
724400	Conductivity sensor
722250	Conductivity calibration solution, 1413 µS/cm, 500 ml

Delivery Content

- SensoDirect Con110 in a sturdy plastic case
- Battery
- Conductivity sensor
- Warranty information
- Instruction manual

Salt110



The portable SensoDirect Salt110 provides fast, accurate readings and the convenience of a remote probe separately.

The measuring range of this salt tester is 0 to 10 % salt (% weight).

The SensoDirect Salt110 includes an automatic temperature compensation feature.

The unit is extremely easy to use and is equipped as standard with a protective casing and built-in electrode holder.

Technical data Salt110

Range	0 - 10 % Salt
Resolution	0,01 % Salt
Temperature compensation	0 - 50 °C, automatically
Accuracy	± 0.5 % Full Scale (23 ± 5 °C)
Ambient conditions	0 - 50 °C 0 - 80 % rel. humidity (non condensing)
Battery	9 V-Block
Dimensions	208 x 110 x 34 mm (L x W x H)
Weight	approx. 380 g
CE-Conformity	
Order code	72 33 00

Delivery Content

- SensoDirect Salt110 in a sturdy plastic case
- Battery
- Sensor
- Warranty information
- Instruction manual

SD Hand-held Meter (IP 67 waterproof)



The new Lovibond® SD series comprises a range of compact, easy-to-use, hand-held instruments for the accurate measurement of pH, ORP, Con, TDS or Salt. With robust housing and fully waterproof (IP67) casing, these testers are the ideal solution for in-situ testing in environmental, industrial or pool & spa applications.

The intuitive scroll-bar functionality and backlit display enable the easy measurement and simultaneous display of

Result | Temperature | Date & Time | Other Measurement Details.

With 25 sets of data storage, each with date and time stamp, the units also enable the easy recalling of data for record keeping requirements.

Designed and manufactured according to Lovibond® quality standards, the series can be upgraded with replaceable electrodes to ensure long-life functionality in the field.

Highlights

- Portable Hand-Held Meter
- Scroll-Through Functionality
- Compact & Robust
- Storage Function
- Backlit Display
- Waterproof (IP67)

Delivery Content

- Meter in a robust plastic case with hanger
- Batteries / without batteries (depending on the order code)
- Lanyard
- Instruction Manual
- SD 50 pH
- additionally: pH 4, 7, 10 buffer tablets (1 strip of 10 tablets each)



SD 50 pH

Range	0 - 60 °C, 0 - 14 pH
Resolution	0.01 pH
Accuracy	± 0.05 pH
Resolution temperature	0.1 °C; Accuracy: ± 1 °C, selectable °C / °F system
Selectable buffer system	pH 7.00 or pH 6.86
Calibration	1, 2, or 3 points calibration with auto-recognition (NIST / IUPAC)
Temperature compensation	Automatic
Memory	Time and date display / stamp with 25 sets of data storage (non-volatile)
Display	22 x 22 mm LCD screen, with yellow/green backlight
Power supply	2 x CR2032 batteries
Battery life	> 25 hours (continuous use, backlight OFF), low battery indicator on LCD screen
Auto-off	8 minutes non-use
Approval	CE
Order code	19 48 00 without batteries 19 48 00-B with batteries 19 48 30 in case with batteries, incl. pH buffer set 4.00 / 7.00 and measurement beaker
Spare electrode	19 48 20

SD 80 TDS

Range	0 - 60 °C, < 10.00 ppt ²⁾
Resolution	1 ppm (<= 999 ppm) 0.01 ppt (1.0 - 10.00 ppt)
Accuracy	± 3 % FS
Resolution temperature	0.1 °C; Accuracy: ± 1 °C, selectable °C / °F system
Auto switch over ppm and ppt	ppm: 0 - 999 ppt: 1.00 - 10.00
Calibration	up to 2 points calibration manual mode ± 50 % adjustable value
Temperature compensation	Automatic
Memory	Time and date display / stamp with 25 sets of data storage (non-volatile)
Display	22 x 22 mm LCD screen, with yellow/green backlight
Power supply	2 x CR2032 batteries
Battery life	> 25 hours (continuous use, backlight OFF), low battery indicator on LCD screen
Auto-off	8 minutes non-use
Approval	CE
Order code	19 48 03 without batteries 19 48 03-B with batteries
Spare electrode	19 48 22

SD 60 ORP

Range	0 - 60 °C, -1800 ~ 1800mV
Resolution	0.1 mV (within ± 1000 mV) 1 mV (outside ± 1000 mV)
Accuracy	± 20 mV
Resolution temperature	0.1 °C; Accuracy: ± 1 °C, selectable °C / °F system
Calibration	1 point calibration with ± 150 mV adjustable ORP value
Temperature compensation	Automatic
Memory	Time and date display / stamp with 25 sets of data storage (non-volatile)
Display	22 x 22 mm LCD screen, with yellow/green backlight
Power supply	2 x CR2032 batteries
Battery life	> 25 hours (continuous use, backlight OFF), low battery indicator on LCD screen
Auto-off	20 minutes non-use
Approval	CE
Order code	19 48 01 without batteries 19 48 01-B with batteries
Spare electrode	19 48 21

SD 90 Salt

Range	0 - 60 °C, < 20.00 ppt ± 2.00 % ³⁾
Resolution	0.01 % (when set to "P" % unit) 1 ppm (< 2000 ppm) 0.01 ppt (2.0 - 20.00 ppt)
Accuracy	± 3 % FS
Resolution temperature	0.1 °C; Accuracy: ± 1 °C, selectable °C / °F system
Auto switch over ppm and ppt	ppm: 0 - 1999 ppt: 2.00 - 20.00
Calibration	up to 2 points calibration manual mode ± 50 % adjustable value
Selectable unit system	"P" % or ppt / ppm
Temperature compensation	Automatic
Memory	Time and date display / stamp with 25 sets of data storage (non-volatile)
Display	22 x 22 mm LCD screen, with yellow/green backlight
Power supply	2 x CR2032 batteries
Battery life	> 25 hours (continuous use, backlight OFF), low battery indicator on LCD screen
Auto-off	8 minutes non-use
Approval	CE
Order code	19 48 04 without batteries 19 48 04-B with batteries
Spare electrode	19 48 22

SD 70 Con

Range	0 - 60 °C, < 20.00 mS ¹⁾
Resolution	1 µS (<= 1999 µS) 0.01 mS (2.0 - 20.00 mS)
Accuracy	± 3 % FS
Resolution temperature	0.1 °C; Accuracy: ± 1 °C, selectable °C / °F system
Auto switch over µS and mS	µS: 1 - 1999 mS: 2.00 - 20.00
Calibration	1 or 2 points calibration for auto mode Standard: 1413 µS or Standard: 12.88 mS up to 2 points calibration for manual mode ± 50 % adjustable value
Temperature compensation	Automatic
Memory	Time and date display / stamp with 25 sets of data storage (non-volatile)
Display	22 x 22 mm LCD screen, with yellow/green backlight
Power supply	2 x CR2032 batteries
Battery life	> 25 hours (continuous use, backlight OFF), low battery indicator on LCD screen
Auto-off	8 minutes non-use
Approval	CE
Order code	19 48 02 without batteries 19 48 02-B with batteries
Spare electrode	19 48 22

Conversion table

- ¹⁾ 0 - 20.00 mS/cm = 0 - 20,000 µS/cm
- ²⁾ 0 - 10.00 ppt TDS = 0 - 10,000 ppm TDS
- ³⁾ 0 - 20.00 ppt NaCl = 0 - 20,000 ppm NaCl
0 - 20.00 ppt NaCl = 0 - 2 % NaCl
0 - 20.00 ppt NaCl = 0 - 20 g/l NaCl
ppm = Parts per Million = mg/l
ppt = Parts per Thousand = g/l



TURBIDITY



TB 300 IR



TB 210 IR



TB 250 WL

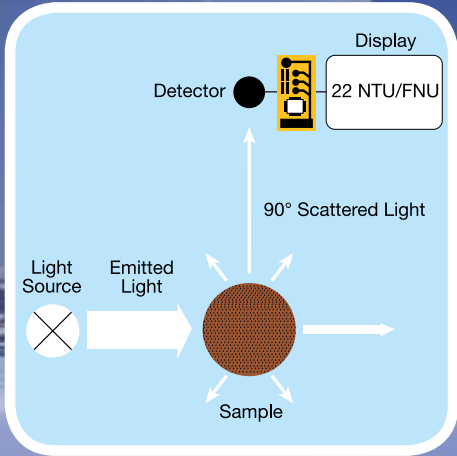

Principle

Turbidity measurement

The term "turbidity" is used to describe the cloudy or milky appearance of liquid or solid media such as water (drinking, mineral, bathing or waste water), beverages (beer, wine or soft drinks) or window glass (translucent glass).

In physical terms, turbidity is due to particles of varying sizes scattering or absorbing light, giving the medium in question a cloudy appearance.

This turbidity is caused by suspended particles such as sludge, limestone, yeast or microorganisms.

In former days, researchers attempted to use visual systems as a means of turbidity measurement. "Jackson Turbidity Units" (JTU), for example, were based on a defined volume of dissolved silicic acid from diatomaceous earth in water. Turbidity was measured using a candle turbidity meter, apparatus comprising a candle and a glass vessel that permitted visual comparison of the suspension with the silicic acid solution.

Today, it is still common practice to test water samples using a white "sight disc" made of cast bronze; the disc is lowered into the water until it can no longer be seen. The turbidity is then calculated on the basis of immersion depth.

Today, the phenomenon of turbidity is measured using optoelectronic meters. An artificial light source emits a known intensity of light through a sample. The suspended particles scatter or absorb the light. The scattered light is then recorded on a photodetector.

Nowadays, the scattered light is generally measured at an angle of 90°. This measurement principle is known as nephelometry. A nephelometer is therefore a turbidity meter that measures scattered light at an angle of 90°. The results are shown in NTU (Nephelometric Turbidity Unit).

To obtain defined, reproducible results, turbidity meters are calibrated and adjusted using formazine solutions (reference standard).

These meters display their results in FNU (Formazine Nephelometric Units).

The result measured by a meter operating on the transmitted light principle is shown in FAUs (Formazine Attenuation Units).

There are two standards for turbidity measurement that are widely accepted at an international level.

EN ISO 7027, "Water quality, determination of turbidity" outlines all the possible methods for turbidity measurement.

All optoelectronic methods require an infrared light source. This also permits testing of coloured samples.

In its method 180.1, "Determination of turbidity by nephelometry", the EPA in the US describes solely the nephelometric (scatter light) method using a so-called white light source (tungsten halogen lamp).

The results measured by different units using the two aforementioned methods cannot be compared.

TB 300 IR with infrared light source



Highlights

- Meets EN ISO 7027
- Automatic overall range adjustment with Standard-Set T-Cal
- Autoranging
- High accuracy
- Laboratory and mobile use
- RS 232 interface
- Storage for up to 1000 data-sets
- Real-time clock
- Waterproof sample chamber and housing

Turbidity is measured according to EN ISO 7027 by nephelometric means (90° scattered light).

The infrared light-source permits measurement of coloured and colour-free samples.

The automatic measurement range detection facility (Autorange) enables direct turbidity measurement from 0.01 to 1100 NTU with an accuracy of $\pm 2\%$ up to 500 NTU and $\pm 5\%$ thereafter.

A large graphic display, a choice of several different languages and user-friendly operating instructions make the device extremely easy to use.

Software updates (for example: languages) can be downloaded free of charge from our website www.lovibond.com.

Technical data

Principle	nephelometric (90° scattered light)
Light source	IR-LED (860 nm)
Keypad	acid and solvent resistant; membrane keypad
Auto – Off	automatic switch off
Display	Graphic-Display
Update	Software update via Internet
Clock	real time clock
Memory	1000 data sets
Sample vol.	approx. 12 ml
Range	0.01 – 1100 NTU (Auto range)
Resolution (NTU)	0.01 from 0.01 - 9.99 0.1 NTU from 10.0 - 99.9 1 NTU from 100 - 1100
Accuracy (NTU)	± 2 % of reading or 0.01 (0 - 500) ± 5 % of reading (500 - 1100)
Ambient conditions	temperature: 5-40 °C at 30-90 % relative humidity (non condensing)
Interface	RS232 for printer and PC-connection
Power supply	7 NiCd rechargeable batteries (Type AA) ; mains adapter (Input: 100-230V) ; and lithium battery for data storage
Weight (instrument)	approx. 1000 g including batteries and power pack
Dimensions	265 x 195 x 70 mm (L x W x H)
CE-Conformity	



Accessories

Set of 12 sample vials with black lid, height 55 mm, ø 24 mm	19 76 55
Cleaning cloth for vials	19 76 35
Rubber seal cap, black for interface and power plug-in	19 80 17 16
Sample chamber lid, black	19 80 11 19
Mains charger, 100-240 V, 50-60 Hz, with international adapters	19 30 10
Universal adapter for socket, international	19 20 65
Connection cable connection to PC, serial 9-pins	19 81 98
Akku AA Mignon, 1100 mAh (7 pc.)	19 50 02 0
Lithium battery	19 50 01 7
Formazin Stock Solution (4000 NTU), 100 ml	19 41 41
Formazin Stock Solution (4000 NTU), 250 ml	19 41 42
Set Turbidity Standards T-CAL (<0.1, 20, 200, 800 NTU)	19 41 50
Paper printer DPN 2335	19 80 75
Roll of paper for printer DPN 2335	19 80 62
Pack of accus for printer DPN 2335	19 80 66
Ribbon cartridge for printer DPN 2335	19 80 67

Delivery Content

- Instrument in carrying case
 - 1 set of turbidity standards T-CAL
 - 7 rechargeable batteries (AA)
 - 1 lithium battery
 - Mains charger, 100-240 V
 - PC connection cable
 - 4 vials (ø 24 mm) with lids
 - Warranty information
 - Certificate of Compliance
 - Instruction Manual
- Order code: 19 40 00-B**
Order code: 19 40 00 (without lithium battery)

TB 210 IR with infrared light source (EN ISO 7027)



The compact Lovibond® infrared turbidity meter TB 210 IR is designed to allow fast, precise on-site testing. The unit measures the scattered light at an angle of 90°, as stipulated in EN ISO 7027.

The wide measuring range from 0.01-1100 TE/F = NTU = FNU makes the instrument suitable for various applications, ranging from drinking water to waste water.

As infrared light is used for measurement purposes, the unit can be used to test both coloured and colourless liquids.

The standards required for calibration of the unit are also supplied. A second adjustment mode allows alternative adjustment with user-defined turbidity standards.

Accessories

Article	Code
Turbidity standard set T-CAL (< 0.1, 20, 200, 800 NTU)	19 41 50
Set empty vials, 24 mm ø (12 pc.)	19 76 55
Cleaning cloth for vials	19 76 35
Sample chamber lid	19 80 11 00
Battery, 9 V	19 50 012
Formazin Stock Solution (4000 NTU), 100 ml	19 41 41
Formazin Stock Solution (4000 NTU), 250 ml	19 41 42

Technical data

Measurement cycle	approx. 8 seconds
Display	backlit LCD (on keypress)
Optics	temperature-compensated LED ($\lambda = 860 \text{ nm}$) and photosensor amplifier in water proof sample chamber, infrared light
Keypad	polycarbonate membrane, splash proof
Power supply	9 V power pack battery
Auto - OFF	automatic switch-off
Storage	internal ring memory for 16 data sets
Additional feature	real time clock and date
Range (Auto-range)	0,01 - 1100 NTU
Resolution	0.01 - 9.99 NTU = 0.01 NTU 10.0 - 99.9 NTU = 0.1 NTU 100 - 1100 NTU = 1 NTU
Accuracy	$\pm 2,5 \%$ of reading or $\pm 0.01 \text{ NTU}$ (0 - 500 NTU) $\pm 5 \%$ (500 - 1100 NTU)
Housing	ABS
Dimensions (L x W x H)	190 x 110 x 55 mm
Weight (base unit)	approx. 0.4 kg
Ambient conditions	Temperature: 5 – 40 °C rel. humidity: 30 – 90 %
CE-Conformity	

Highlights

- Range 0.01 - 1100 NTU
- Measurement with infrared light at an angle of 90°
- Measurement of coloured liquids
- Easy handling
- 600 tests without battery change

Delivery Content

- Instrument in carrying case
- 4 turbidity standards (< 0,1, 20, 200 and 800 NTU)
- 9 V battery
- 2 vials (ø 24 mm) with lids
- Warranty information
- Certificate of Compliance
- Instruction Manual

Order code: 26 60 20

TB 250 WL with white light source

Technical data

Display	large LCD display
Keypad	5 key polycarbonate membrane, splash proof
Power supply	4 AA Alkaline batteries for approx. 20 h continuous operation or 3500 tests
Range	0.01 to 1100 NTU
Accuracy	± 2% of value or 0.01 NTU (0-500 NTU) ± 3% of value (500-1100 NTU)
Resolution	0.01 NTU to 99.99 NTU 0.1 NTU from 100.0 to 999.9 NTU 1.0 NTU from 1000 to 1100 NTU
Housing	ABS
Dimensions	210 x 95 x 45 mm
Weight	approx. 0.45 kg (base unit)
Ambient conditions	Temperature: 0 – 50 °C rel. humidity: 0 – 90 %
CE-Conformity	



Accessories

Set of secondary standards
0.02, 10, 1000 NTU
Order code: 19 42 80

Set of 3 vials
with black lids
Order code: 19 42 90

The TB 250 WL allows easy turbidity measurement in either the field or in the laboratory. Using a „white light“ source and 90° detection, the TB 250 WL meets the specifications for EPA turbidity measurement (EPA Standard 180.1). A power efficient micro-circuit design allows the instrument to yield 5000 tests on 4-AA alkaline batteries with an estimated 7-10 year bulb life. Integrated diagnostics confirm proper operation and accuracy. The instrument features an Auto-Ranging feature that automatically selects the correct turbidity range for your sample. Calibration is simple with the included calibration standards. The instrument comes with all required items for testing including the TB 250 WL Turbidimeter, sample cuvettes, batteries, calibration set, operators manual and carrying case.



Highlights

- Ideal for regulatory monitoring, process control or field use
- Simple operation
- Easy calibration
- Auto-Ranging
- Meets USEPA

Delivery content

- Instrument in a sturdy handy case
 - 2 sample vials
 - 3 turbidity standards
 - 4 batteries
 - Instruction manual
 - Warranty information
- Order code: 19 42 80**

Floc Testers



Floc testers with continuously variable stirring speed for laboratory and field use

Highlights

- Continuously variable stirring speed
- Digital display
- Height adjustment of the stirring blades during operation
- Timer feature

Applications

- Flocculant Manufacturer
- Waste Water Treatment Plants
- Laboratories
- Research Centres
- Universities

ET 740 (laboratory)

Stirring places	four
Stirring speed control	10 - 300 revolutions per minute
Resolution	1 revolution
Timer	1 - 999 minutes or 0 - 99 hours (continuous)
Power supply	100 – 240 V, 50 - 60 Hz
Weight	approx. 13 kg
Dimensions (mm)	645 L x 347 W x 260 H
EC-conformity	CE
Order code	2 41 91 55

ET 750 (laboratory)

Stirring places	six
Stirring speed control	10 - 300 revolutions per minute
Resolution	1 revolution
Timer	1 - 999 minutes or 0 - 99 hours (continuous)
Power supply	100 – 240 V, 50 - 60 Hz
Weight	approx. 17 kg
Dimensions (mm)	935 L x 347 W x 260 H
EC-conformity	CE
Order code	2 41 91 60

ET 730 (portable/field)

Stirring places	four
Stirring speed control	20 - 40 - 50 - 100 - 200 revolutions per minute
Timer	1 - 30 minutes (continuous)
Power supply	100 – 240 V, 50 - 60 Hz
Weight	approx. 4.8 kg
Dimensions (mm)	250 L x 320 W x 250 H
EC-conformity	CE
Order code	2 41 91 50

Accessories

Measuring beaker, glass, low form, 1000 ml	41 91 65
Measuring beaker, PP, low form, 1000 ml	41 91 66
Bag for transport of ET 730	41 91 51

Floc testers are designed for a range of applications – such as testing the efficiency of flocculation or precipitation agents.

The ET 740 model with 4 stirring places and the ET 750 model with 6 stirring places are fitted with an illuminated back panel for glare-free observation of the samples and are suitable for laboratory use.

The floc tester ET 730 with 4 stirring places is primarily designed for field use. The 4 stirring points are arranged in a circle around a lamp making it easier to observe the flocculation process.

State-of-the-art technology ensures maximum operating convenience and makes the unit maintenance-free. The main features of the laboratory floc testers are the continuously variable stirring speed, the digital display of stirring rpm, the timer function, the illuminated back panel, and the height adjustment option for the stirring blades during operation.

For model ET 730 beakers with 1000 ml volume, low form can be used.

For models ET 740 and ET 750 beakers with 1000 ml - 1500 ml volume, low or high form can be used.

The beakers are **not** included. Please contact your laboratory distributor.



POOL PRODUCTS



Rapid Tests



PM Photometer



Rapid Tests



Highlights

- Easy to use
- Futuristic design
- RAPID tablets fast dissolving
- Highest accuracy

Active Oxygen
Biguanide (PHMB)
Bromine
Calcium Hardness
Chlorine
Copper

Cyanuric acid
Hydrogen Peroxide
pH-value
QAC
Total Alkalinity
Total Hardness



Water Treatment

pH value

The pH value of pool & spa water should generally be between the slightly acidic value of 6.5 and the slightly basic value of 7.6. Due to the use of various water treatment chemicals as well as ambient environmental effects, pool owners have to determine the pH of the water and correct the value as necessary.

Disinfection

Nowadays, pool owners can choose from a range of modern water treatment agents that are often used in combination.

These water treatment chemicals are only effective within a limited pH range. Therefore in addition to checking the concentration of the water treatment chemicals, the owner/operator should also monitor the pH value of pool water and adjust it if necessary.

Rapid Tests

Minitester

The Minitester is a competitively priced starter unit with one measuring chamber for the determination of either chlorine, bromine, active oxygen and the pH value.

Three-Chamber Tester

The Three-Chamber Tester is a competitively priced unit for the determination of disinfectants and the pH value.

Pooltester / Multipooltester

The Pooltester is designed for the simultaneous determination of the most popular water treatment agents and the pH value.

Additionally the Multipooltester allows the determination of cyanuric acid, total alkalinity and calcium hardness.





Minitester

Item	Code
Chlorine-pH¹⁾ Chlorine 0.1–3.0 mg/l / pH value 6.8–8.2	15 70 60
Bromine-pH¹⁾ Bromine 1–8 mg/l / pH value 6.8–8.2	15 80 20
Active Oxygen-pH¹⁾ Active Oxygen 0–10 mg/l / pH value 6.8–8.2	15 73 80

Three-Chamber-Tester

Item	Code
Chlorine-pH LR, in mini case Chlorine 0.1–3.0 mg/l / pH-Wert 6.8–8.2	15 77 00
Chlorine-pH LR¹⁾ Chlorine 0.1–3.0 mg/l / pH value 6.8–8.2	15 75 20
Chlorine-pH HR¹⁾ Chlorine 0.5–6.0 mg/l / pH value 6.8–8.2	15 80 10
Bromine-pH¹⁾ Bromine 1.0–8.0 mg/l / pH value 6.8–8.2	15 72 00
Active Oxygen-pH¹⁾ Active Oxygen 0–10 mg/l / pH value 6.8–8.2	15 76 10
Biguanide (PHMB)-pH¹⁾ Biguanide (PHMB) 10–100 mg/l pH value 6.8–8.2	15 61 50
4 in 1²⁾ Chlorine LR 0.1–3.0 mg/l / pH value 6.8–8.2 Cyanuric acid 20–200 mg/l Alkalinity-M 50–300 mg/l	15 17 00

¹⁾ in bubble pack ; ²⁾ in plastic case

Pooltester

Item	Code
Chlorine-pH LR Chlorine 0.1–3.0 mg/l / pH value 6.8–8.2	15 16 00
Chlorine-pH HR Chlorine 0.5–6.0 mg/l / pH value 6.8–8.2	15 16 01
Bromine-pH Bromine 1.0–8.0 mg/l / pH value 6.8–8.2	15 16 04
Active Oxygen-pH O ₂ 0–10 mg/l / pH value 6.8–8.2	15 16 05
Copper LR/HR-pH Copper LR 0.1–1.0 mg/l & HR 0.5–5.0 mg/l pH value 6.8–8.2	15 51 90
Active Oxygen-Copper-pH O ₂ 0–10 mg/l / Copper 0.1–1.0 mg/l pH value 6.8–8.2	15 52 35
Biguanide (PHMB)-Hydrogen Peroxide (H₂O₂)-pH PHMB 10–100 mg/l / H ₂ O ₂ 5–50 mg/l pH value 6.8–8.2	15 61 00
Quaternary Ammonia Compounds (QAC)-pH QAC 25–150 mg/l / pH value 6.8–8.2	15 10 40
5 in 1 Multipooltester, Chlorine 0.1–3.0 mg/l / pH value 6.8–8.2 Cyanuric acid 20–200 mg/l Alkalinity-M 20–800 mg/l Calcium hardness 20–800 mg/l	15 19 00

Delivery content

- Minitester in a bubble pack
- Tablet reagents for 20 tests
- Instruction manual
- Pack contains 6 units

Delivery content

- Three-Chamber-Tester in a bubble pack
- Tablet reagents for 20 tests
- Instruction manual
- Pack contains 6 units

Delivery content

- Pooltester in a sturdy plastic box
- Tablet reagents for 20 tests
- Instruction manual
- Pack contains 6 units

Refill Packs

Item	Code
Chlorine / pH* 30 DPD No. 1 / RAPID-tablets and 30 PHENOL RED / RAPID-tablets	51 58 84
Bromine / pH* 30 DPD No. 1 / RAPID-tablets and 30 PHENOL RED / RAPID-tablets	51 58 68
Active Oxygen - pH* 30 DPD No. 4 / RAPID-tablets and 30 PHENOL RED / RAPID-tablets	51 59 34
Active Oxygen - Copper - pH* 20 DPD No. 4 / RAPID-tablets 20 COPPER No. 1-tablets and 20 PHENOL RED / RAPID-tablets	51 58 65
PHMB/H₂O₂ - pH 20 PHMB-, 20 H ₂ O ₂ -, 20 ACIDIFYING PT- and 20 PHENOL RED / RAPID-tablets	51 58 70
PHMB - pH* 30 PHMB-tablets and 30 PHENOL RED / RAPID-tablets	51 61 55
QAC HR - pH* 20 QAC-, 20 ACIDIFYING GP- and 20 PHENOL RED / RAPID-tablets	51 58 69
Copper - pH* 30 COPPER No. 1-tablets and 30 PHENOL RED / RAPID-tablets	51 57 78
Combi pack for Three-Chamber-Tester 4 in 1 20 DPD No. 1 / RAPID-, 20 PHENOL RED / RAPID-, 20 ALK LR- 20 CyA-TEST-tablets	51 59 35
Combi pack for Multipooltester 5 in 1 20 DPD No. 1 / RAPID-, 20 DPD No. 3 / RAPID-, 20 PHENOL RED / RAPID-, 20 CyA-TEST 10 ALK TEST- 10 CAL-TEST-tablets	51 59 80

* Each pack contains 12 units

Reagents

Item	Quantity	Code
Acidifying GP	100 pc. 250 pc.	51 54 80BT 51 54 81BT
Acidifying PT	100 pc. 250 pc.	51 54 90 51 54 91
ALK LR	100 pc.	51 60 40BT
ALK TEST	100 pc.	51 55 70BT
CAL TEST	100 pc.	51 55 80BT
Copper No. 1 ★	100 pc. 250 pc.	51 35 50BT 51 35 51BT
Cyanuric Acid CyA-TEST	100 pc. 250 pc.	51 13 70BT 51 13 71BT
DPD No. 1 / RAPID ★	100 pc. 250 pc. 500 pc.	51 13 10BT 51 13 11BT 51 13 12BT

Item	Quantity	Code
DPD No. 3 / RAPID ★	100 pc. 250 pc. 500 pc.	51 12 90BT 51 12 91BT 51 12 92BT
DPD No. 4 / RAPID ★	100 pc. 250 pc. 500 pc.	51 15 70BT 51 15 71BT 51 15 72BT
Hydrogenperoxide HR	100 pc. 250 pc.	51 59 40BT 51 59 41BT
PHENOL RED / RAPID	100 pc. 250 pc. 500 pc.	51 17 90BT 51 17 91BT 51 17 92BT
PHMB	100 pc. 250 pc.	51 58 90BT 51 58 91BT
QAC HR	100 pc. 250 pc.	51 54 00 51 54 01

★ also suitable for seawater



Highlights

- Lovibond®-RAPID tablets
DPD and PHENOL RED
will dissolve quickly,
have a guaranteed
10 year shelf-life
and are provided in
green-printed foil blister.
- Material Safety Data Sheets:
www.lovibond.com

PM Photometers

Data transfer via Bluetooth® or Infrared

The ultimate range
in Pool Photometers

For reliable
pool relevant
water analysis



Highlights

- Intuitive operation
- Back-lit display
- User guide in German, English, French, Spanish, Italian, Portuguese, Polish & Indonesian
- Stores up to 1000 results
- One Time Zero (OTZ)
- Bluetooth® data transfer (PM 630)
- Infrared interface (PM 600 / PM 620) for IRiM data transfer
- Waterproof^{*)}

^{*)} as defined in IP 68, 1 hour at 0.1 meter

Active oxygen
Alkalinity-M (total)
Aluminium
Ammonia
Bromine
Calcium hardness
Chlorine
Chlorine dioxide
Copper
Cyanuric acid
Hardness, total
Hardness, calcium

Hydrogen peroxide
Iron
Iodine
Langelier Index
Ozone
pH
PHMB (Biguanide)
Phosphate
Sulphate
Sodium Hypochlorite
Urea
Water Balance

Photometers PM 600 / PM 620

The PM 600 and PM 620 photometer range brings pool testing to the next level for discerning pool operators. The ergonomic, portable, waterproof design enables users to select just one unit for accurate analysis of up to 34 parameters anytime and anywhere.

The **PM 600** focusses on the main pool parameters required for balanced water including: Alkalinity, Bromine, Chlorine, Cyanuric Acid, Iron, Calcium Hardness, Copper, Sodium Hypochlorite, Ozone and pH-value. Compatible with the tried and trusted Lovibond® Tablet reagents, it is designed to be robust, reliable yet easy-to-use for any pool operator.

The **PM 620** extends these capabilities to include up to 34 parameter variants from Acid Demand to Urea. Its unique design enables compatibility with Lovibond® Tablet, Liquid and Powder reagents, making it one of the most flexible and complete pool photometers available today.

Both units offer a large, back-lit graphic display to aid analysis by providing on-screen method prompts, information regarding test measurement range and reagent type and automatic countdown timers for accurate reaction periods. The internal memory is capable of storing up to 1000 results with date, time and sample ID. These results can be reviewed at any time and can be downloaded to a PC via an additional Infra-Red module (IRiM)¹.

Supplied in a durable, portable case complete with accessories and space for additional reagents, both photometers provide immediate access to the accurate water analysis expected of the Lovibond® brand, clearly the best choice for water analysis.

* available as an option : IRiM (infrared interface Modul)

Photometer PM 630

The PM 630 introduces data management and **Bluetooth®** functionality to the highly proven PM 600 series of photometers. Already simplifying accurate water analysis with 34 pre-calibrated pool methods, the series has now been expanded to include Bluetooth® data transmission. Now, results can be quickly and easily transferred to smartphones and tablets.

The system is further enhanced by the free Lovibond® App, **AquaLX®**, enabling the immediate review, process and evaluation of measured results directly on-site. Data trends can be monitored with easy-to-view graphical displays with set minimum and maximum values. Any fluctuation to expected results is immediately visible and instant action can be taken.

Furthermore, additional personalized information, such as the name of the pool and the pool engineer can be recorded, providing a complete information record of the measurement.

Technical Data

Display	Graphic-display
Interfaces	Infrared ¹ (PM 600 / PM 620), Bluetooth® 4.0 (PM 630), RJ45 socket for Internet updates ²
Optics	LEDs, interference filters (IF) and photo sensor in transparent sample chamber
Wavelength Accuracy	± 1 nm
Photometric Accuracy*	2 % FS (T = 20 °C – 25 °C)
Photometric Resolution	0.005 A
Operation	Acid and solvent resistant, touch-sensitive keypad with audible feedback via integrated beeper
Power Supply	4 batteries (Mignon AA/LR6); Operation time: approx. 26 h continuous operation or 3500 tests
Auto-Off	approx. 20 minutes after last keypress with audible signal
Dimensions	approx. 210 x 95 x 45 mm (unit) approx. 395 x 295 x 106 mm (case)
Weight (unit)	approx. 450 g
Ambient Conditions	5–40 °C at max. 30–90 % rel. humidity (non condensing)
Language Selection	German, English, French, Spanish, Italian, Portuguese, Polish, Indonesian ; additional languages via Internet update
Memory Capacity	approx. 1000 data sets
Approval	CE

¹ optional available: IRiM (Infrared Interface Modul)

² optional available: connection cable with integrated electronics (RS 232 / RJ-45 plug)

* tested with standard solutions

Records can be transferred at the touch of a button by email either as a graphic or database record, simplifying the transfer, management and sharing of results.

AquaLX® compliments the Langelier Index App, **PoolM8**, which negates the need for complex calculations for Balanced Water. By simply entering the results of the parameters (pH; Total Alkalinity; Calcium Hardness; Total Dissolved Solid; Temperature.), the App automatically determines and displays the results which can then be saved to create a history and, again, shared via email.

Both Lovibond® Apps are available for Android™ and iOS®.

 **Please see pages 78 onwards for reagents (order codes)**

Reference Standard Kits

The reference standards are designed to check the accuracy and the reliability of the results.

It is not possible to calibrate the photometer with the reference standards.

The shelf life of reference standards is two years from the date of production, provided that storage and use are in accordance with the instructions provided.

Reference Standard Kit Chlorine 21 56 30
0.2* and 1.0* mg/l
for tablet and VARIO methods ¹⁾

Reference Standard Kit Chlorine 21 56 35
0.5* and 2.0* mg/l
for tablet methods only

Reference Standard Kit Chlorine 21 56 36
1.0* and 4.0* mg/l
for tablet methods only

Reference Standard Kit pH 21 56 65
7.45* pH

* Approximate figure, actual figure specified in certificate of analysis enclosed

¹⁾ The standard values mentioned in kit 215630 for the VARIO method are for photometer PM 620 only, because this method is not available in the PM 600

Verification Standard Kit

The verification standard kit for the photometers PM 600 / 620 / 630 is designed to assure the user of the accuracy and the reliability of the results related to the integrated wave lengths. The shelf life of the verification standard kit is two years from the date of production, provided that storage and use are in accordance with the instructions provided.

Measurements are taken in mAbs.























Verification Standard Kit 21 56 80

























Delivery Content

- Instrument in carrying case
- 4 batteries (AA)
- 3 round vials 24 mm ø
- 1 syringe, 1 brush, 1 stirring rod
- 1 plastic beaker 100 ml
- Warranty information
- Certificate of Compliance
- Instruction Manual
- **PM 600** (13 parameter, infrared)
 - 100 tablet reagents each for chlorine (free, combined, total), pH value, calcium hardness, alkalinity-M
 - Order code: 21 40 60**
- **PM 620** (34 parameter, infrared)
 - 100 tablet reagents each for chlorine (free, combined, total), pH value, cyanuric acid, alkalinity-M
 - Order code: 21 40 65**
- **PM 630** (34 parameter, Bluetooth®)
 - 100 tablet reagents each for chlorine (free, combined, total), pH value, cyanuric acid, alkalinity-M
 - Order code: 21 40 70**





























Bluetooth® is a wireless technology subject to regional approval. The use of the MD 610 with Bluetooth® is currently only permitted within the EU, the USA, and in Canada. The use of the MD 610 will also be possible in other regions in the future. For current regions and further information, visit: www.lovibond.com/bluetooth
Regions in which the MD 610 with Bluetooth® can currently be used (status: 01/2015):
within the EU (according R&TTE Directive 1999/5/EC) ; USA (according to FCC part 15, comprised in FCC ID QOQBT113) ; Canada (comprised in IC 5123A-BGTBLE113)























Applications of Lovibond® Reagents

Parameter	Reagent	Application
Acid capacity Ks4.3	ALKA-M-PHOTOMETER	 = Water
Acid concentration	ACID CONCENTRATION	 = Waste Water
Alkalinity-M	ALKA-M-PHOTOMETER	 = Seawater
Alkalinity-P	ALKA-P-PHOTOMETER	 = Boiler Water related
Aluminium	ALUMINIUM No. 1 ALUMINIUM No. 2	 = Pool Water related
Aluminium	VARIO Aluminum ECR/F20 VARIO Aluminum Hexamine/F20 VARIO Aluminum Masking Reagent	 = Reagent Test
Amine	Amine	 = Tube Test
Ammonia vario	VARIO Ammonia Salicylate F10 VARIO Ammonia Cyanurate F10	
Ammonia	AMMONIA No. 1 AMMONIA No. 2 Conditioning powder	  
Ammonia LR	VARIO Ammonia Salicylate F5 VARIO Ammonia Cyanurate F5 VARIO Am Diluent Reagent LR	
Ammonia HR	VARIO Ammonia Salicylate F5 VARIO Ammonia Cyanurate F5 VARIO Am Diluent Reagent HR	
Arsenic (III, V)	Chemicals see manual	
Boron	BORON No. 1 BORON No. 2	
Bromine	DPD 1 Buffer solution DPD 1 Reagent solution	
Bromine	DPD No. 1 DPD No. 1 HIGH CALCIUM	 
Cadmium (Cd²⁺)	Spectroquant® 1.14834.0001	
Chloride	CHLORIDE T1 CHLORIDE T2	
Chloride	RT (Chloride-51 / Chloride-52)	
Chlorine	DPD No. 1 RAPID DPD No. 3 RAPID DPD No. 4 RAPID	





Parameter	Reagent	Application	
Chlorine	DPD No. 1		 = Water  = Waste Water  = Seawater  = Boiler Water related  = Pool Water related RT = Reagent Test KT = Tube Test
	DPD No. 3		
	DPD No. 1 HIGH CALCIUM		
Chlorine	DPD 1 Buffer solution DPD 1 Reagent solution DPD 3 Solution		
Chlorine	VARIO Chlorine FREE-DPD/F10 VARIO Chlorine TOTAL-DPD/F10		
Chlorine HR (KI)	ACIDIFYING GP CHLORINE HR (KI)		
Chlorine dioxide	DPD No. 1		
	DPD No. 3		
	GLYCINE		
Chlorine dioxide	DPD 1 Buffer solution DPD 1 Reagent solution		
Chromium	PERSULF. RGT FOR CR Chromium Hexavalent		
COD LR	Reaction tube 0-150 mg/l		
COD MR	Reaction tube 0-1500 mg/l		
COD HR	Reaction tube 0-15000 mg/l		
Colour (Spectral Absorption Coefficient)	---		
Copper	COPPER / ZINC LR		
Copper	COPPER / ZINC HR		
Copper	COPPER No. 1		
	COPPER No. 2		
Copper, free	VARIO Cu 1 F 10		
Cyanide	Reagent test set, consists of: Cyanide-11/ -12 / -13		
Cyanuric acid	CyA-TEST		
DEHA	DEHA Solution DEHA		
DEHA	VARIO OXYSCAV 1 Rgt VARIO DEHA 2 Rgt Solution		

Applications of Lovibond® Reagents

Parameter	Reagent	Application	
Fluoride	SPADNS-Reagent Fluoride Standard		 = Water
Fluoride	Fluoride A-Z Fluoride Excess Al		 = Waste Water
Formaldehyde	Spectroquant® 1.14678.0001		 = Seawater
Formaldehyde	Spectroquant® 1.14500.0001		 (B) = Boiler Water related
Hardness, Calcium	CALCHECK		 (P) = Pool Water related
Hardness, total	HARDCHECK P		RT = Reagent Test
Hardness, total	Hardness Yes/No		KT = Tube Test
Hardness, total	T Hardness-Test		
Hardness, total	Total Hardness		
Hazen (Pt-Co-Scale; APHA)	---		
Hydrazine	Hydrazine Test Powder Spoon		
Hydrazine	Vacu-vials® / Chemetrics K-5003		
Hydrogen peroxide	HYDROGENPEROXIDE LR		
Iodine	DPD No. 1		
Iron (II, III) soluble	Vario Ferro F10		
Iron (II, III) soluble	IRON LR IRON (II) LR		
Iron	IRON HR		
Iron (TPTZ)	Vario TPTZ F10		
Lead (Pb ²⁺)	Spectroquant® 1.09717.0001		
Lead (Pb ²⁺)	Spectroquant® 1.14833.0001		
Manganese	MANGANESE LR 1 MANGANESE LR 2		
Manganese	VARIO Ascorbic Acid VARIO Alkaline-Cyanide VARIO PAN Indicator		
Molybdate	MOLYBDATE No. 1 HR MOLYBDATE No. 2 HR		

Parameter	Reagent	Application	
Nickel	RT (Nickel-51, Nickel-52)		 = Water
Nitrate	KT (Nitrate-111)		 = Waste Water
Nitrate	VARIO Nitrate Chromotropic VARIO Nitra X Reagent tube VARIO Deionised water		 = Seawater
Nitrate	NITRITE LR Nitrate Test Tablets Nitrate Test Powder		 = Boiler Water related  = Pool Water related
Nitrate HR	Nitracheck No.1 Nitracheck No.2		RT = Reagent Test KT = Tube Test
Nitrite	KT (Nitrit-101)		
Nitrite	NITRITE LR		
Nitrite	Nitrite No.1 Nitrite No.2		
Nitrogen-total	KT (Reagent for digestion, Reagent for compensation, Nitrat-111)		
Nitrogen, total LR	VARIO TN HYDROX. LR tubes VARIO PERSULFATE Reagent VARIO TN Reagent A VARIO TN Reagent B VARIO TN ACID LR/HR tubes VARIO Deionised water		
Nitrogen, total HR	VARIO TN HYDROX HR tubes VARIO PERSULFATE Reagent VARIO TN Reagent A VARIO TN Reagent B VARIO TN ACID LR/HR tubes VARIO Deionised water		
Oxygen, active	DPD No. 4		
Oxygen, active	INDIGO CARMINE		
Oxygen, dissolved	Vacu-vials® / Chemetrics K-7553		
Ozone	DPD No. 1 DPD No. 3 GLYCINE		
Ozone	Ozone		
Phenols	Phenole No. 1 Phenole No. 2		

Applications of Lovibond® Reagents

Parameter	Reagent	Application
PHMB (Biguanide)	PHMB PHOTOMETER	 = Water
Phosphate-Organo	ORGANO-PHOSPHONATE No.1 ORGANO-PHOSPHONATE No.2	 = Waste Water
Phosphate HR	PHOSPHATE HR	 = Seawater
Phosphate-total* (PMB)	KT (Phosphate-101, Phosphate-102, Phosphate-103)	 = Boiler Water related
Phosphate-total* (PMB)	KT (Phosphate-101, Phosphate-102, Phosphate-103)	 = Pool Water related
Phosphate-ortho (VM)	KT	RT = Reagent Test
Phosphate LR, ortho	PHOSPHATE LR No. 1 PHOSPHATE LR No. 2	KT = Tube Test
Phosphate HR, ortho	PHOSPHATE HR No. 1 PHOSPHATE HR No. 2	
Phosphate, ortho	VARIO Phos 3 F10	
Phosphate, ortho	VARIO Dilution Vial VARIO Phos 3 F10 VARIO Deionised water	
Phosphate, acid hydrolyzable	Content see: Phosphate, total, set, additional: VARIO Natriumhydroxid 1,00 N	
Phosphate, total	VARIO Acid Reagent Vial VARIO Phos 3 F10 VARIO Potassium Persulfate VARIO Natriumhydroxid 1,54 N VARIO Deionised water	
pH value	BROMOCRESOLPURPLE/PHOTOM.	
pH value	PHENOLRED RAPID	
pH value	PHENOLRED / PHOTOMETER	
pH value	PHENOLRED Solution	
pH value	THYMOLBLUE/PHOTOMETER	
pH value	METHYL RED	
pH value	CRESOL RED	
pH value	BROMOPHENOL BLUE	
pH value	BROMOCRESOL GREEN	
pH value	M-CRESOLPURPLE	
pH value	UNIVERSAL PH	

 = Water

 = Waste Water

























 = Seawater

 = Boiler Water related

 = Pool Water related

RT = Reagent Test

KT = Tube Test

Parameter	Reagent	Application	
Potassium	POTASSIUM T		 = Water
QAC	QAC Test		 = Waste Water
QAC LR	QAC LR		 = Seawater
QAC HR	QAC HR		 = Boiler Water related
Silica	SILICA No. 1 SILICA No.2 SILICA PR		 = Pool Water related
Silica	VARIO LR Amino Acid F F10 VARIO Citric Acid F10 VARIO Molybdate 3 Rgt Solution		RT = Reagent Test KT = Tube Test
Silica	VARIO Silica HR Acid Rgt F10 VARIO Silica Citric Acid F10 VARIO Silica Molybdate F10		
Sulphate	SULFATE T		
Sulphate	VARIO Sulpha 4 / F10		
Sulphate	SULFATE No.1 SULFATE No.2		
Sulphide	SULFIDE No. 1 SULFIDE No. 2		
Sulphite	SULFITE LR		
Sulphite	SULFITE No.1 SULFITE No.2 HR SULFITE No.2 LR		
Surfactants (anionic)	Spectroquant® 1.14697.0001		
Tannin	TANNIN No.1 TANNIN No.2		
TOC	Spectroquant® 1.14879.0001		
Turbidity	---		
Urea	UREA-Reagent 1 UREA-Reagent 2 AMMONIA No. 1 AMMONIA No. 2		
Zinc	COPPER / ZINC LR EDTA DECHLOR		

Index

A

Acid Capacity KS4.3

PM 620 & PM 630 140

Alkalinity-M

5 in 1 Multipooltester 138

Comparator 2000+ 26

MD 100 54

MD 200 58

MD 600 & MD 610 64

MINIKIT 10

MultiDirect 68

PM 600 140

PM 620 & PM 630 140

Rapid Tests 136

SpectroDirect 72

Three-Chamber-Tester 138

Alkalinity-P

MD 600 & MD 610 64

MINIKIT 10

MultiDirect 68

SpectroDirect 72

Aluminium

CHECKIT®Comparator 12

Comparator 2000+ 26

MD 100 54

MD 600 & MD 610 64

MultiDirect 68

PM 620 & PM 630 140

SpectroDirect 72

VARIO Powder Packs 102

Amine

Comparator 2000+ 26

Ammonia

CHECKIT®Comparator 12

Comparator 2000+ 26

MD 100 54

MD 600 & MD 610 64

MultiDirect 68

PM 620 & PM 630 140

SpectroDirect 72

VARIO Powder Packs 102

Arsenic

SpectroDirect 72

Arsenic Test Kit 11

B

BD 600 108

Biguanide (PHMB)

POOLTESTER 138

Rapid Tests 136

THREE-CHAMBER-Tester 138

BOD 108

Boron

MD 600 & MD 610 64

MultiDirect 68

SpectroDirect 72

Brom

Drei-Kammer-Tester 138

Bromine

CHECKIT®Comparator 12

Comparator 2000+ 26

MD 100 54

MD 200 58

MD 600 & MD 610 64

MINITESTER 138

MultiDirect 68

PM 600 140

PM 620 & PM 630 140

POOLTESTER 138

Rapid Tests 136

SpectroDirect 72

THREE-CHAMBER-Tester 138

VARIO Powder Packs 102

C

Cadmium

SpectroDirect 72

Calcium hardness

5 in 1 Multipooltester 138

Calcium Hardness

CHECKIT®Comparator 12

MD 100 54

MD 200 58

MD 600 & MD 610 64

MINIKIT 10

MultiDirect 68

PM 600 140

PM 620 & PM 630 140

Rapid Tests 136

CHECKIT®Comparator 12

Chloride

Comparator 2000+ 26

MD 100 54

MD 600 & MD 610 64

MINIKIT 10

MultiDirect 68

SpectroDirect 72

Chlorine

5 in 1 Multipooltester 138

CHECKIT®Comparator 12

Comparator 2000+ 26

MD 100 54

MD 200 58

MD 600 & MD 610 64

MINITESTER 138

MultiDirect 68

PM 600 140

PM 620 & PM 630 140

POOLTESTER 138

SpectroDirect 72

THREE-CHAMBER-Tester 138

VARIO Powder Packs 102

Chlorine Dioxide

CHECKIT®Comparator 12

Comparator 2000+ 26

MD 100 54

MD 200 58

MD 600 & MD 610 64

MultiDirect 68

PM 620 & PM 630 140

SpectroDirect 72

VARIO Powder Packs 102

Chromium

Comparator 2000+ 26

SpectroDirect 72

COD

MD 100 62

MD 200 62

MD 600 & MD 610 64

MultiDirect 68

SpectroDirect 72

VARIO Powder Packs 102

COD Setups

COD Setup MD 100 COD VARIO 62

COD Setup MD 200 COD VARIO 62

Comparator 2000+ 26

Conductivity

SD 70 124

SD 320 Con 116

SensoDirect 110 122

SensoDirect 150 120

Copper

CHECKIT®Comparator 12

Comparator 2000+ 26

MD 100 54

MD 200 58

MD 600 & MD 610 64

MultiDirect 68

PM 600 140

PM 620 & PM 630 140

POOLTESTER 138

Rapid Tests 136

SpectroDirect 72

VARIO Powder Packs 102

Cyanide

Comparator 2000+ 26

MD 600 & MD 610 64

MultiDirect 68

SpectroDirect 72

Cyanuric acid

5 in 1 Multipooltester 138

Rapid Tests 136

Cyanuric Acid

CHECKIT®Comparator 12

Comparator 2000+ 26

MD 100 54

MD 200 58

MD 600 & MD 610 64

MINIKIT 10

MultiDirect 68

PM 600 140

PM 620 & PM 630 140

SpectroDirect 72

D

DEHA

- CHECKIT®Comparator 12
- Comparator 2000+ 26
- MD 100 54
- MD 600 & MD 610 64
- MultiDirect 68
- SpectroDirect 72
- VARIO Powder Packs 102

DPD Reagents 76

F

Fluoride

- CHECKIT®Comparator 12
- Comparator 2000+ 26
- MD 100 54
- MD 600 & MD 610 64
- MultiDirect 68
- SpectroDirect 72

Formaldehyde

- SpectroDirect 72

H

Hand-Held Meters

- MicroDirect 124
- SD 300 pH 116
- SD 310 Oxi 116
- SD 320 Con 116
- SD series 124
- SensoDirect 110 122
- SensoDirect 150 120

Hazen

- Comparator 2000+ 26
- MD 100 54
- MultiDirect 68
- SpectroDirect 72

Hydrazine

- Comparator 2000+ 26
- MD 100 54
- MD 600 & MD 610 64
- MultiDirect 68
- SpectroDirect 72
- VARIO Powder Packs 104

Hydrogen Peroxide

- Comparator 2000+ 26
- MD 100 54
- MD 600 & MD 610 64
- MultiDirect 68
- PM 620 & PM 630 140
- POOLTESTER 138
- Rapid Tests 136
- SpectroDirect 72

I

Indicator Systems 76

Iodine

- Comparator 2000+ 26
- MD 600 & MD 610 64
- MultiDirect 68
- PM 620 & PM 630 140
- SpectroDirect 72

IRIM 67

Iron

- CHECKIT®Comparator 12
- Comparator 2000+ 26
- MD 100 54
- MD 200 58
- MD 600 & MD 610 64
- MultiDirect 68
- PM 600 140
- PM 620 & PM 630 140
- SpectroDirect 72
- VARIO Powder Packs 104

L

Langelier Water Balance

- MD 600 & MD 610 64
- MultiDirect 68
- PM 600 & PM 620 140

Lead

- SpectroDirect 72

Liquid Reagents 76

M

Manganese

- CHECKIT®Comparator 12
- Comparator 2000+ 26
- MD 100 54
- MD 600 & MD 610 64
- MultiDirect 68
- SpectroDirect 72
- VARIO Powder Packs 104

MD 100 54

MD 200 58

MD 600 & MD 610 64

Membrane Filter Set 77

MINIKIT 10

MINITESTER 138

Molybdate / Molybdenum

- CHECKIT®Comparator 12
- Comparator 2000+ 26
- MD 100 54
- MD 600 & MD 610 64
- MultiDirect 68
- SpectroDirect 72
- VARIO Powder Packs 104

MultiDirect 68

N

Nessleriser 29

Nickel

- Comparator 2000+ 26
- MultiDirect 68
- SpectroDirect 72

Nitrate

- CHECKIT®Comparator 12
- Comparator 2000+ 26
- MD 600 & MD 610 64
- MultiDirect 68
- SpectroDirect 72
- VARIO Powder Packs 104

Nitrite

- CHECKIT®Comparator 12
- Comparator 2000+ 26
- MD 600 & MD 610 64
- MINIKIT 10
- MultiDirect 68
- SpectroDirect 72
- VARIO Powder Packs 106

Nitrogen

- MD 600 & MD 610 64
- MultiDirect 68
- SpectroDirect 72
- VARIO Powder Packs 104

O

Organo-Phosphonate

- MINIKIT 10

ORP

- SD 60 124
- SensoDirect 150 120

Oxygen

- Comparator 2000+ 26

Oxygen, active

- MD 600 & MD 610 64
- MINITESTER 138
- MultiDirect 68
- PM 620 & PM 630 140
- POOLTESTER 138
- Rapid Tests 136

Oxygen, dissolved

- MD 100 54
- MD 600 & MD 610 64
- MultiDirect 68
- SD 310 Oxi 116
- SensoDirect 150 120

Ozone

- CHECKIT®Comparator 12
- Comparator 2000+ 26
- MD 100 54
- MD 600 & MD 610 64
- MultiDirect 68
- PM 600 140
- PM 620 & PM 630 140
- SpectroDirect 72

P

PD 250 100

Permanganate

Comparator 2000+ 26

pH

5 in 1 Multipooltester 138

CHECKIT®Comparator 12

Comparator 2000+ 26

MD 100 54

MD 200 58

MD 600 & MD 610 64

MINITESTER 138

MultiDirect 68

PM 600 140

POOLTESTER 138

Rapid Tests 136

SD 50 124

SD 300 pH 116, 118

SensoDirect 110 122

SensoDirect 150 120

SpectroDirect 72

THREE-CHAMBER-Tester 138

Phenols

SpectroDirect 72

PHMB (Biguanide)

MD 600 & MD 610 64

MultiDirect 68

Phosphate

CHECKIT®Comparator 12

Comparator 2000+ 26

MD 100 54

MD 600 & MD 610 64

MultiDirect 68

PM 600 140

PM 620 & PM 630 140

SpectroDirect 72

VARIO Powder Packs 106

Phosphonates

MultiDirect 68

SpectroDirect 72

VARIO Powder Packs 106

Photometers

MD 100 54

MD 200 58

MultiDirect 68

PM 600, PM 620 & PM 630 140

SpectroDirect 72

Photometry 52

PM 600 & PM 620 140

Polyacrylates

MD 100 54

Pool & Spa Products 136

POOLTESTER 138

Potassium

MD 600 & MD 610 64

MultiDirect 68

SpectroDirect 72

Powder Dispenser PD 250 100

Powder Pack 77

Q

QAC

Comparator 2000+ 26

MINIKIT 10

POOLTESTER 138

Rapid Tests 136

R

Rapid Tests 136

RD 125 63

Reagents 76

Redox

SD 60 124

SD 300 pH 116, 118

SensoDirect 150 120

Reference Standard Kit

MD 100 57

MD 200 61

Reference Standard Kits

PM 600 & PM 620 141

S

Salinity

SD 90 124

SD 320 Con 116

SensoDirect 110 122

Sample Preparation 77

SD 50 pH 124

SD 60 ORP/Redox 124

SD 70 Con 124

SD 80 TDS 124

SD 90 Salt 124

SD 300 pH 116

SD 310 Oxi 116

SD 320 Con 116

SD series 124

SensoDirect 110 122

SensoDirect 150 120

Silica

CHECKIT®Comparator 12

Comparator 2000+ 26

MD 100 54

MD 600 & MD 610 64

MultiDirect 68

SpectroDirect 72

VARIO Powder Packs 106

Sodium hypochlorite

PM 600 140

PM 620 & PM 630 140

Sodium Hypochlorite

CHECKIT®Comparator 12

Comparator 2000+ 26

MD 600 & MD 610 64

MultiDirect 68

Spark-free cabinets - EX series 114

Spectral Absorption-Coefficient

SpectroDirect 72

SpectroDirect 72

Spectrophotometer 72

Sugar

Comparator 2000+ 26

Sulphate

Comparator 2000+ 26

MD 100 54

MD 600 & MD 610 64

MINIKIT 10

MultiDirect 68

PM 620 & PM 630 140

SpectroDirect 72

VARIO Powder Packs 106

Sulphide

Comparator 2000+ 26

MD 600 & MD 610 64

MultiDirect 68

SpectroDirect 72

Sulphite

CHECKIT®Comparator 12

MD 600 & MD 610 64

MINIKIT 10

MultiDirect 68

SpectroDirect 72

Surfactants (anionic)

SpectroDirect 72

Suspended Solids

MD 100 54

MultiDirect 68

SpectroDirect 72

T

Tablet Reagents 76

Tannin

MINIKIT 10

TB 210 IR 130

TB 250 WL 131

TB 300 IR 128

TDS

SD 80 124

SD 320 Con 116

SensoDirect 150 120

Temperature

SD 300 pH 116

SD 310 Oxi 116

SD 320 Con 116

SD Hand-held Meters 124

SensoDirect 150 120

Thermoreactor 63

Thermostatically controlled incubators - TC series 112

THREE-CHAMBER-Tester 138

Stabilizer 138

TOC

SpectroDirect 72

Total Alkalinity

CHECKIT®Comparator 12

Total Hardness

- Comparator 2000+ 26
- MD 100 54
- MD 600 & MD 610 64
- MINKIT 10
- MultiDirect 68
- PM 620 & PM 630 140
- Rapid Tests 136
- SpectroDirect 72

Total Nitrogen

- SpectroDirect 72

Triazoles

- MD 100 54
- MD 600 & MD 610 64
- VARIO Powder Packs 106

Tube Tests 76

Turbidity

- MultiDirect 68
- SpectroDirect 72
- TB 210 IR 130
- TB250 WL 131

Turbidity meters 126

U

Urea

- MD 100 54
- MD 200 58
- MD 600 & MD 610 64
- MultiDirect 68
- SpectroDirect 72

V

VARIO Powder Packs 76

VARIO Reagents 106

Verification Standard Kit

- MD 100 57
- MD 200 61
- MD 600 & MD 610 65
- MultiDirect 71
- PM 600 & PM 620 141

W

Waste Water Set-Up MD 600 63

Waste Water Set-Ups 63

Waste Water Set-Up SpectroDirect 63

Z

Zinc

- CHECKIT®Comparator 12
- Comparator 2000+ 26
- MD 100 54
- MD 600 & MD 610 64
- MultiDirect 68
- SpectroDirect 72