

Technical features

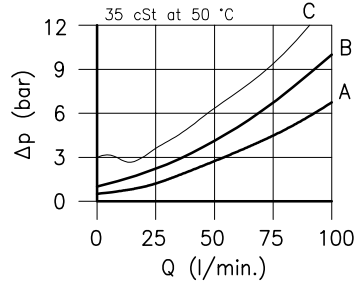
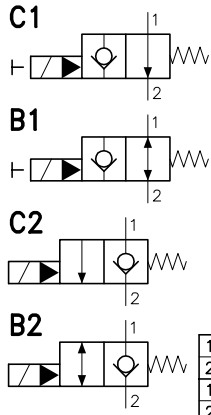

	22C1	22B1	22C2	22B2
1 → 2 De-en.	curve A	curve A	not allowed	not allowed
2 → 1 De-en.	not allowed	curve A	curve B	curve B
1 → 2 Energ.	not allowed	not allowed	curve A	curve A
2 → 1 Energ.	curve C	curve C	not allowed	curve A

Cavity (For dimensions see catalogue 17.000)	S 50/2
Max. flow (l/min.)	90
Max. pressure (bar)	210
Response time (ms) <small>It change in function of circuit, pressure, flow and fluid viscosity.</small>	80 - 120 <small>(Mean value)</small>
Fluid viscosity range (cSt)	2.8 - 380
Fluid temperature range (°C)	-20 +80
Mass (kg)	0.400
Hydraulic fluid; mineral oil HM and HV	ISO 6074
Recommended filtration; 19/15 ISO 4466 (25 μ absolutes)	
Standard seals in Polyurethane and Buna N	

Dimensions

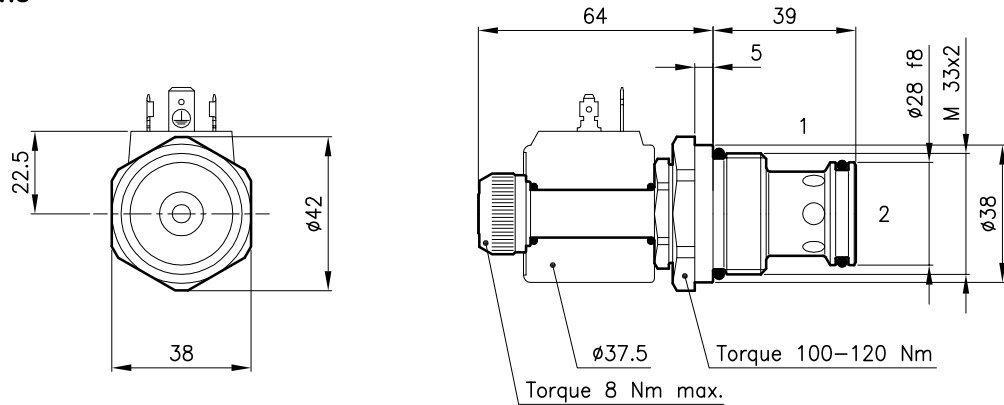

Ordering informations

ECP 50/22C1-MO

ECP 50/22.. = Valve type

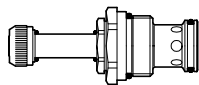

Circuits

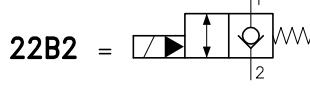
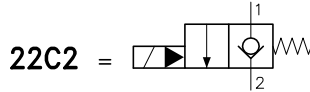
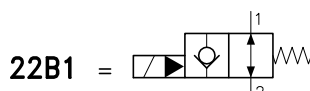
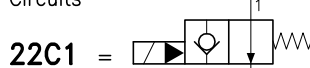

MO = Manual override (Only C1 and B1 version)
(Omit if not request)

Codes:

ECP 50/22C1	55 011 105
ECP 50/22C1-MO	55 011 158
ECP 50/22B1	55 011 104
ECP 50/22B1-MO	55 011 159
ECP 50/22C2	55 011 107
ECP 50/22B2	55 011 106
External seals kit	90 620 106

ECP 50/22.. valves can be assembled on standard bodies 50-L0 series; for dimensions see catalogue 16.010

On the ECP 50 valves must be assembled the Coils B20 series; for dimensions, features and codes see catalogues 09.900 and 09.901.